

Performance Analysis of Bit Interleaved Coded Irregular Modulation

S.Ramya¹, R.Prabu²

Student, Department of ECE, Paavai College of Engineering, Pachal, Namakkal, India ¹

Assistant Professor, Department of ECE, Paavai College of Engineering, Pachal, Namakkal, India ²

ABSTRACT: Efficient transmission is achieved by improving the flexibility and adaptiveness of Bit Interleaved Coded Modulation (BICM) system. The BICM system can be used with the iterative decoding (ID) at the receiver side; hence BICM system is called as BICM-ID system. The performance of BICM-ID system can be improved by using different types of mapping and constellation, where each bit within a codeword has different mapping. The bitwise interleaver is used between the encoder and modulator. Hence the system is thus called as Bit Interleaved Coded Irregular modulation (BICIM). Along with this, an iterative decoding and demapping is performed at the receiver side. The entire is termed as BICIM-ID system. The need for BICIM system is adapt the data rate with the channel characteristics. And the irregular modulation makes the system to decode, according to the system requirements. Combination of few mappings makes the new mapping method for different application. The performance of the system can be analysed by calculating the BER, SNR and efficiency of the system

KEYWORDS: Bit Interleaved Coded Modulation (BICM); Bit Interleaved Coded Irregular Modulation (BICIM), Iterative Decoding (ID).

I.INTRODUCTION

For effective transmission, the communication system needs the high data rate with high reliability and system should use the available spectrum in an efficient way. Another way is to use available spectrum is by choosing the suitable modulation techniques. Some of the broadcast systems are designed with flexible modulation, which can be used to provide the reliable communication in any channel environment. The capacity of the broadcast system can be limited by transmission parameter and channel impairment. The broadcast system is designed with bit rate that can be received by all users in an intended coverage area. Recent broadcast systems are designed with flexible transmission parameters by choosing the different constellation.

Communication system needs high data rate as transmission rates with high power and bandwidth efficiency. To achieve the quality of service, the minimum ratio of signal to noise power is required. The minimum bandwidth is required to transmit the desired data rate. The design of communication system includes providing the solution to reduce the computational complexity, end to end delay and the information must be transmitted with small error probability. To achieve these, desirable channel capacities, higher order of modulation and the channel codes are needed.

Higher order modulation is used to improve bandwidth efficiency. Bandwidth efficiency is improved by transmitting several bits per channel through a signal points of a given signal constellation. Channel coding is to improve the power efficiency by introducing the redundancy. The redundancy is to protect the transmitted data against channel impairments and enable the receiver to correct transmission errors. The coded modulation includes the design of both coding and modulation. In the wireless environment, the channel characteristics are changing with time. In order to maximize the data rate over a time varying channel, the transmission parameters are adapted using the channel estimation which is available at the transmitter. The adaptation of transmission parameters are made by varying transmitted power level, signal constellation and data rate. The flexible adaptation to the channel quality is possible with the modulation.

International Journal of Innovative Research in Science, Engineering and Technology

(An ISO 3297: 2007 Certified Organization)

Vol. 4, Special Issue 6, May 2015

While transmitting the data over the channel, the base band input data streams are usually shift the frequency to radio frequency through the modulation process. By using some of the complex modulation, more data can be transmitted over the same fixed bandwidth. More than one channel can be multiplexed or transmitted at the same time without interference with each others; this can be made possible through the modulation process. Some other limitations are occurred in communication systems. They are signal attenuations, multipath fading, interference and shadowing. By using the error correcting codes and diversity technique, the effect of noise and fading are reduced, so the communication reliability can be improved.

For the bandwidth efficient transmission over the fading channel, hierarchically modulated BICM system has been used. Due to some of the complexity, this system cannot be suitable for most of the application. The system consists of serial concatenation of encoder, interleaver and modulator whereas at the receiver side the iterative decoding, demapping and demodulation are performed. Hence the BICM can be called as BICM-ID system. It is not possible for all receivers to receive the additional data that is transmitted along with the required system data. In order to overcome this issue, the system is designed without using the hierarchical modulation. BICIM-ID can be designed by performing the few modifications in the BICM-ID system. The modifications are made in terms of mapping and constellation. BICIM system can be given as, applying different constellation and mapping within one codeword. The irregular mapping and signal constellation are considered for iterative decoding and demapper process. The iterative decoding process is considered along with BICM system in order to improve the performance of the system. Based on the system requirements different types of interleavers are used.

The need for BICIM-ID system is to adapt system with the time varying channel. In order to maximize the transmitted data rate, the transmission parameters has to be adapted with the varying channel, where the channel estimation is available at the transmitter. If the channel estimation is not available then the usage of channel capacity remains inefficient. To overcome this issue, assume that the channel has good characteristics and also there is a retransmission of data is performed. Retransmission of data is needed when the decoder is unable to decode the received data. Modulation is used to achieve the high flexible adaptation with the channel quality. The adaptation is achieved by varying the size of the signal constellation or code rate.

II. EXISTING SYSTEM

In the existing system, hierarchical modulation (HM) was considered along with the BICM-ID system. The system consists of serial concatenation of source, interleaver and modulator [7] and at the receiver side; the system consists of iterative decoder, deinterleaver and demodulator. Hence the system is called as HM BICM-ID system. The HM system has two sources namely high priority and low priority. These data are separately encoded and interleaved [5]. The interleaved data are modulated and finally transmitted over the channel. When the data is transmitted over the channel some noises added to the transmitted sequences. The objective of the encoder is to map the incoming signal

The received sequence are demodulated and decoded to obtain the original transmitted sequence. The purpose of using iterative decoding is to provide the extrinsic information as prior information. The SISO decoder sends extrinsic information to hierarchical demodulator. During the second iteration, hierarchical demodulator takes interleaved version as prior information of coded bits to generate extrinsic information for SISO decoder. The bitwise interleaver is used between the encoder and modulator. Hence they are named as Bit Interleaved Coded Modulation. The feedback is provided between the demodulator and decoder [5]. Hence they are termed as Iterative Decoding. Along with the BICM, iterative decoding is used to improve the performance of the system. The existing system uses 16 QAM constellation and gray mapping. The purpose of using HM is to improve the performance of the system, but the HM is a time consuming process and it is not suitable for all channel conditions. It has high bit error rate and hence efficiency was unable to improve further.

III. PROPOSED SYSTEM

The various issues in HM BICM-ID system has been overcome by considering the BICIM-ID system. Due to the complexity in receiving the high and low priority data separately, HM is not included in the proposed system. This is

International Journal of Innovative Research in Science, Engineering and Technology

(An ISO 3297: 2007 Certified Organization)

Vol. 4, Special Issue 6, May 2015

because; it is not possible for all receivers to receive the separate data in any channel environment. Hence the single source is considered in the proposed system. The BICIM-ID system has different constellation and also have different mappings. Each symbol in a codeword have different mapping, this is to improve the performance of the system and also to improve the efficiency of the system. Instead of designing new mapping technique for different application, combination of two mapping provides various mapping characteristics. The performance of the system is analyzed by calculating the BER, SNR and efficiency.

A.SYSTEM MODEL

Transmitter block diagram of BICIM-ID system is considered in figure1, where the input data bits are generated and they are encoded in channel encoder. The encoder is to map the incoming signal into channel input and for the decoder is to map the channel output into an output signal in such a way that the effect of channel noise is minimized. The combined role of channel encoder and decoder is to provide for reliable communication over a noisy channel. Then these encoded bits are interleaved by bitwise interleaver. Each bit is interleaved in order to avoid to errors. To improve the performance of coding in fading channels, coding is typically combined with interleaving to overcome the effect of burst errors. The size of the interleaver must be large enough so that fading is independent across a received codeword. Slow fading channel requires large interleavers, which in turns can lead to large delay. Now the interleaved bits are modulated through BPSK modulation techniques where the constellation is 16 BPSK constellations and mapping is irregular [3] so each bit in the codeword has the separate mapping. After mapping, the signal is transmitted through the channel. While the signal is transmitted over the channel some noise are added to the transmitted signal. Such noise is termed as AWGN. The transmitted signal are represented as $s(t)$.

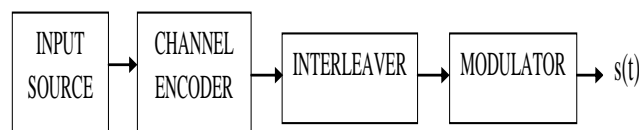

Figure: 1 Transmitter block diagram

Receiver block diagram of BICIM-ID system is shown in figure2, the received signal can be represented as $r(t)$.

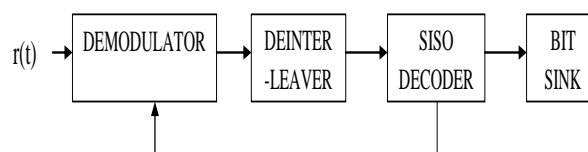

Figure: 2 Receiver block diagram

The received signals are demodulated and they are deinterleaved which is followed by decoder to decode the signals. Iterative decoding technique is used at the receiver side in order to recover the original signal from the noisy received signal. The system is said to be iteratively decoding system when there is a feedback of decoded signal to the demodulator. Based on the iterative decision on the receiver side, demapping process is occurred. While transmitting a signal over the channel some noises are added to the signal, they are represented as $n(t)$ [5].

The received signal is represented as follows,

$$r(t) = s(t) + n(t)$$

The advantage of BICIM-ID system can be given as, the different constellation is to adapt the data rate with channel characteristics and the mixture of different mapping is to make decoding process to satisfy system requirements. In order to achieve these conditions the BICM system is designed with the different signal constellation and mapping.

The AWGN can be defined as, Additive White Gaussian Noise [4]. It is a basic noise model used in the information theory. It can be briefly explained as; additive means it is added to any noise that may be added intrinsic to the information system. White refers to it has uniform power across the frequency band for the information system.

International Journal of Innovative Research in Science, Engineering and Technology

(An ISO 3297: 2007 Certified Organization)

Vol. 4, Special Issue 6, May 2015

Gaussian refers it has a normal distribution in time domain with an average time domain value of zero. Generally noise is referred as unwanted signal added to the original signal, which degrades the performance of the system [6].

The channel is discrete-time additive white Gaussian noise channel with the channel input and output relationship can be given as follows [2],

$$y[i] = x[i] + n[i]$$

Where $x[i]$ represents the channel input at the time i , $y[i]$ represents the channel output at the time i , and $n[i]$ is white gaussian noise random process. The channel bandwidth is given as B and the transmitted power as P . The channel SNR is thus given as, power in $x[i]$ divided by the power in $n[i]$, which is constant. They can be represented as,

$$\gamma = P / (N_0B)$$

Here N_0 represents power spectral density of noise. The probability of symbol error depends on the received SNR. The capacity of AWGN channel is larger than the fading channel. The channel capacity can be given as [2] ,

$$C = B \log_2 (1+\gamma)$$

The unit of channel capacity is described in bits/seconds.

IV. MODULATION AND DECODING

This section describes about the BPSK modulation and its constellation and mapping. It also describes about the iterative decoding and demapping occurred at the receiver side.

A. MODULATION

In digital modulation keying techniques, an analog carrier signal is modulated by a binary code. The basic types of digital modulation techniques are Amplitude Shift Keying, Frequency Shift Keying and Phase Shift Keying respectively. The basic principle of pass band digital modulation is to encode an information bit stream into a carrier signal which is then transmitted over a communications channel. Demodulation is the process of extracting this information bit stream from the received signal. Corruption of the transmitted signal by the channel can lead to bit errors in the demodulation process. The modulation is to send bits at a high data rate while minimizing the probability of data corruption. In general, modulated carrier signals encode information in the amplitude, frequency, or phase of a carrier signal. For BPSK, each symbol consists of a single bit [1]. In BPSK, the transmitted signal is of fixed amplitude. It has one fixed phase when the data is at one level and when the data is at the other level, phase is different by 180 degree. In Phase Shift Keying technique, the phase of the carrier is changed according to input the data signal. BPSK is the simplest form of PSK. It uses two phases which are 0° and 180° . The digital modulator serves as an interface between the transmitter and the channel.

B. CONSTELLATION

The different constellation is provided to adapt the data rate with the channel characteristics. Rectangular and hexagonal constellations have a better power efficiency than the square or circular constellations associated with QAM and PSK, respectively. These irregular constellations can save up to 1.3 dB of power at the expense of increased complexity in the constellation map. The optimal constellation shape is a sphere in N-dimensional space, which must be mapped to a sequence of constellations in 2-dimensional space in order to be generated by the modulator [1]. For uncoded modulation, the increased complexity of spherical constellations is not suitable for their energy gains, since coding can provide much better performance at less complexity.

The constellation diagram of BPSK has their constellation points lying entirely on the x axis. It has no projection on the y axis. This means that the BPSK modulated signal will have an in-phase component (I) but no quadrature component (Q). This is because it has only one basis function [1].

The binary PSK system consists of the pair of signals $S_1(t)$ and $S_2(t)$ used to represent binary symbols 1 and 0, respectively.

The mathematical representation of BPSK can be defined by [6],

For binary 1,

$$S_1(t) = \sqrt{(2E_b/T_b)} (\cos 2\pi f_c t)$$

Whereas for binary 0,

$$S_2(t) = \sqrt{(2E_b/T_b)} (\cos 2\pi f_c t + \pi)$$

E_b is the transmitted signal energy per bit, where f_c is the frequency of the carrier.

International Journal of Innovative Research in Science, Engineering and Technology

(An ISO 3297: 2007 Certified Organization)

Vol. 4, Special Issue 6, May 2015

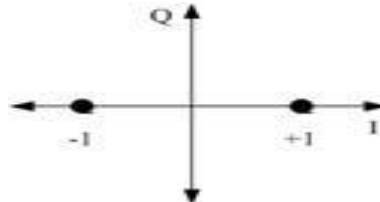

Figure: 3 BPSK constellation diagram

The phase of the signal is represented by the angle around the circle, and the amplitude by the distance from the origin or centre of the circle. Most phase shift keyed systems use a constant amplitude and therefore points appear on one circle with constant amplitude and the changes in state being represented by movement around the circle. For binary shift keying using phase reversals the two points appear at opposite points on the circle. Other forms of phase shift keying may use different points on the circle and there will be more points on the circle.

By using the constellation view of the signal enables the quick fault finding in a system. If the problem is related to phase, the constellation will spread around the circle. If the problem is related to magnitude, the constellation will spread off the circle, either towards or away from the origin. These graphical techniques assist in isolating problems much faster than when using other techniques.

C.MAPPING

By using different signal constellations, there is an assignment of different bit-to-symbol mappings within one codeword. The design of mapping depends on the size of the constellation. With Gray mapping, the binary labels of signal points at minimum Euclidean distance can be differed by only one bit, thus minimizing the error probability of most probable symbol error event at minimum Euclidean distance [2]. If noise or distortions cause misclassification in the receiver, Gray coding can minimise the bit error rate. BER can be minimized because there is a single bit variation of the signal from its neighbour [2]. The occurrence of bit of noise that cause the received signal vary by one spot in the constellation only causes a single bit error. Gray mapping is the best choice for all symbols if there is no priori information is available at the demapper. Based on distance properties, various methods have been considered to find the optimal mapping rules. The different mapping for each bit in a codeword is considered to improve the performance of the system [3].

When the receiver is performing iterative demapping and decoding, the resultant sequence is closer to ideal a priori information, it may available at the demapper after several iteration for high SNR. When the ideal a priori information is available, the signal constellation is reduced to two signal points whose labels differ only in the bit. In order to maximize the gain over the iterations and to optimize the performance at high SNR, then maximize the minimum Euclidean distance between symbols whose bit label differ in one bit. This can be in contrast to the design rules for Gray mapping, where the aim is to minimize the Euclidean distance between symbols. Gray mapping means of reducing the error rate. Mapping for specific application can be designed according to the specific rules, but by using the irregular mapping instead of designing mapping for particular application, the combination of different mapping provides the different mapping characteristics

The minimum Euclidean distance is denoted as the free Euclidean distance. Euclidean distance spectrum (EDS) is used to characterize and analyze mappings and to provide the error bounds [2]. The properties of the signal constellation are inherently included in the EDS. The EDS is the average or cumulated Hamming distance between bit labels at a specific Euclidean distance. The Hamming distance is equivalent to the number of bit errors made while choosing the wrong signal point. The EDS depends on the amount of available a priori information. The EDS provides an exact characterization of the mapping with ideal a priori information. With the ideal a priori information, all bits except the bit to be detected are a priori known and the signal constellation is reduced to a binary constellation. Depending on the actual a priori information, different symbol pairs remain. The labels of the two remaining signal points differ only in the bit to be detected. Hence the different mappings are used for performance improvement.

International Journal of Innovative Research in Science, Engineering and Technology

(An ISO 3297: 2007 Certified Organization)

Vol. 4, Special Issue 6, May 2015

D. ITERATIVE DECODING

At the receiver side, the received signals are demodulated and they are iteratively decoded. The iterative decoding is used along with the BICIM to improve the system performance. When the feedback loop is present, the BICIM system is referred to as BICIM with iterative decoding. [2] The purpose of using iterative decoding is to provide extrinsic information. SISO decoder sends extrinsic information to demodulator. During second iteration demodulator takes priori information of coded bits to generate extrinsic information for SISO decoder [5]. The system is based on the iterative exchange of extrinsic information between the constituent soft-in/soft-out decoders of concatenated codes separated by interleaver. The successive exchange of extrinsic information is analyzed by a sum-product algorithm. The demapper uses the received value and the transmitted symbol from the signal constellation to obtain estimates about the corresponding bits where the bit sequence is mapped to the symbol according to bit-to-symbol mapping. BICIM decoding process based on the iterations algorithm This SISO module is called the SISO demapper. The SISO demapper can be implemented in the LLR domain [5]. The performance of BICIM can be further improved by using SISO demodulation and decoder at the receiver side.

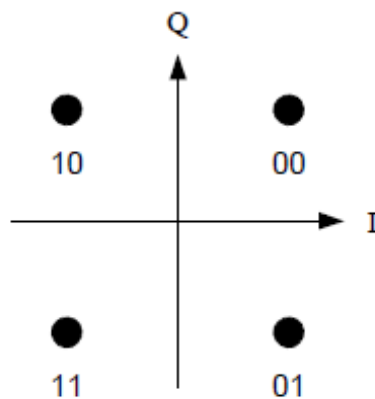

Figure: 4 constellation diagram

The probabilities which are considered are sequence and bit error probabilities, these probabilities are called as the posteriori probabilities. Therefore, the algorithms which considering these probability perform maximum a posteriori probability decoding. If the a priori probabilities are not considered, then the maximum likelihood decoding is performed. With hard decision decoding, the size of the considered channel output alphabet Y is equal to the size of the input alphabet X. With soft decision decoding, the channel state information is incorporated in the decoding process. Then, the channel output alphabet is larger than the channel input alphabet and the reliability of the received values is taken into account to improve the performance. The system is based on the iterative exchange of extrinsic information between the constituent soft-in/soft-out decoders of concatenated codes separated by interleaver. The successive exchange of extrinsic information is understood as an instance of the sum-product algorithm. The constellation and mapping is considered to improve the performance of the system. The performance of BICM-ID has been better than the performance of BICIM-ID system in terms of efficiency. The efficiency improvement indicates better performance of the system.

V. BER ANALYSIS AND FLOW CHART

A. BER ANALYSIS

The performance of system has been obtained by calculating the various factors such as BER, SNR and also efficiency. The BER for BPSK is [6],

$$P_e = \frac{1}{2} \operatorname{erfc}(\sqrt{E_b/N_0})$$

Where E_b represents energy per bit and N_0 represents noise spectral density. By increase the transmitted signal per energy bit, for a specified noise spectral density, the message points corresponding to symbols 1 and 0 move further

International Journal of Innovative Research in Science, Engineering and Technology

(An ISO 3297: 2007 Certified Organization)

Vol. 4, Special Issue 6, May 2015

apart, and the average probability of error P_e is correspondingly reduced in accordance with the above equation. P_e is the BER, or equivalently the SER (Symbol error rate) for the optimum BPSK modulator. [4] This is the best possible error performance any BPSK modulator-demodulator can achieve in presence of AWGN. The BER of QPSK is same as the BER of BPSK. Another parameter for performance analysis is SNR and efficiency.

B.FLOW CHART

This is the transmitter and receiver side coding flow can be according to the following flow chart.

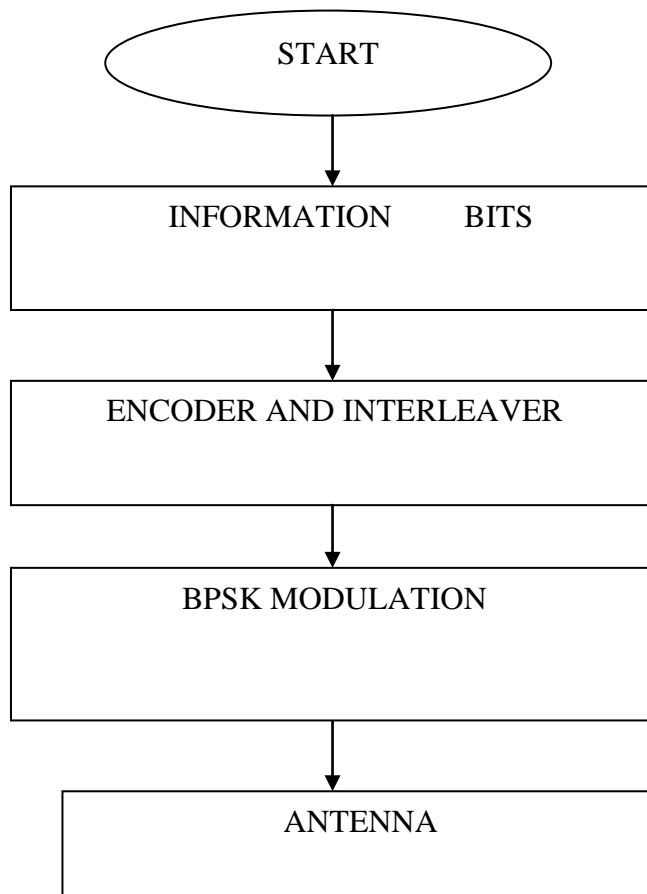

Figure: 5 Flow chart of transmitter

The input data are obtained and they are bitwise encoded then they are modulated by binary phase shift keying where the mapping and constellation are performed.

International Journal of Innovative Research in Science, Engineering and Technology

(An ISO 3297: 2007 Certified Organization)

Vol. 4, Special Issue 6, May 2015

The receiver flow chart can be drawn as follows,

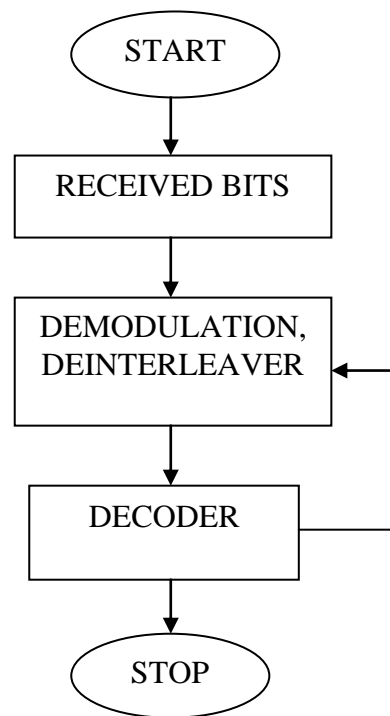

Figure: 6 Receiver flow chart

The received bits are demodulated where demapping process takes place. Then they are iteratively decoded through SISO decoder. The feedback is to provide the prior information.

VI. SIMULATION RESULTS

The BICIM-ID system can be designed and their performance can be obtained by calculating the BER, SNR and efficiency. The graph can be drawn between BER and SNR. Another graph has been drawn between SNR and efficiency. In order to improve the performance of the system and also improve efficiency of the system, the BER should be reduced. SNR should be high. The noise added at the channel can degrade the performance of the system hence these noises are removed at the receiver side during the iterative decoding process.

BER of BICIM-ID can be obtained by using Binary Erasure Channel [5]; here BER can be estimated without numerical simulation. Analytical BER can be obtained by extrinsic information transfer. To analyze the BER performance of BICIM, by using an approach similar to that used in the analysis of PCCC and SCCC. In the decoding of BICIM, errors occur when the decoded symbol sequence is not the transmitted sequence. Such error events are the concatenation of length error events in the mapper trellis. Good BER approximations (or predictions) that show the impact on constellation parameters and mapping rules can be achieved. Analytical bounds on the bit error rate (BER) are developed and based on these bounds, the optimum interleaver design. The obtained graphs can be given as follows. The graph has been thus plotted between the SNR and BER.

When compared to BICM system the BER of BICIM system has been reduced.

International Journal of Innovative Research in Science, Engineering and Technology

(An ISO 3297: 2007 Certified Organization)

Vol. 4, Special Issue 6, May 2015

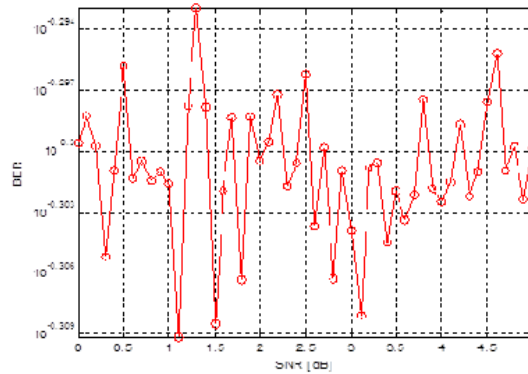

Figure: 7 Graph between BER versus SNR

Another graph has been plotted between SNR and efficiency.

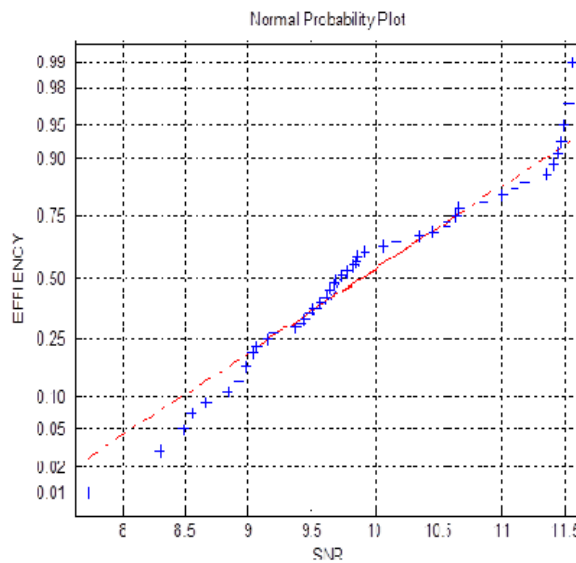

Figure: 8 Graph between SNR and efficiency

VII. CONCLUSION AND FUTURE WORK

Based on the simulation result, the performance and efficiency of BICIM-ID has been improved when compared to BICM-ID system. The performance improvement has been improved by varying the modulation technique and also by using the different mapping for each bit within codeword. The BICIM-ID system offers a promising possibility to adapt the transmission system to the channel quality, the complexity and error rate requirements. BICIM is well suited for the combination with bit loading and power loading schemes if additional channel knowledge is available at the transmitter. The additional complexity of BICIM is very low. The performance of the system can be improved in terms of the efficiency improvement as well as reduction in the bit error rate. By future the system can be improved by considering the 32 QAM or 32 BPSK constellations. Based on the simulation result, the performance of BICIM-ID system has been improved when compared to the BICM-ID system.

International Journal of Innovative Research in Science, Engineering and Technology

(An ISO 3297: 2007 Certified Organization)

Vol. 4, Special Issue 6, May 2015

REFERENCES

- [1] Andrea Goldsmith, 'Wireless Communications'.
- [2] Jun Tan and Gordon L. Stuber (2005), 'Analysis and Design of Symbol Mappers for Iteratively Decoded BICM', IEEE TRANSACTIONS ON WIRELESS COMMUNICATIONS, VOL.4, NO. 2,
- [3] Md. Jahangir Hossain, Alex Alvarado and Leszek Szczecinski, 'Constellation and Interleaver Design for BICM'.
- [4] Pavan K. Vitthaladevuni and Mohamed-Slim Alouini, 'A Recursive Algorithm for the Exact BER Computation of Generalized Hierarchical QAM Constellations'. IEEE Transactions On Information Theory, VOL. 49, NO. 1.
- [5] Qiaoyu Li, Jun Zhang, Lin Bai and Jinho Choi (2014), 'Performance Analysis and System Design for Hierarchical Modulated BICM-ID', IEEE Transactions on Wireless Communications, Vol.13, No.6.
- [6] Simon Haykin, "Communication systems", third edition, John Wiley & sons pte. Ltd.
- [7] Xiaodong Li, Aik Chindapol and James A. Ritcey, 'Bit-Interleaved Coded Modulation with Iterative Decoding and 8PSK Signaling'.