

# Design and Analysis of Decoder Circuit Using Quantum Dot Cellular Automata (QCA)

M. Prabakaran<sup>1</sup>, N.Indhumathi<sup>2</sup>, R.Vennila<sup>3</sup> and T.Kowsalya<sup>4</sup>

PG Scholars, Department of E.C.E, Muthayammal Engineering College, Rasipuram, Namakkal, Tamilnadu, India<sup>1</sup>.

PG Scholars, Department of E.C.E., Muthayammal Engineering College, Rasipuram, Namakkal, Tamilnadu, India<sup>2</sup>

Assistant Professor, Department of E.C.E, Muthayammal Engineering College, Rasipuram, Namakkal, Tamilnadu, India<sup>3</sup>

Professor Head, Muthayammal Engineering College, Rasipuram, Namakkal, Tamilnadu, India<sup>3</sup>

**ABSTRACT:** Quantum Dot Cellular Automata (QCA) is one of the emerging trends in the field of nanotechnology which help to overcome the limitations of CMOS technology. QCA is simple in structure having significantly lesser elements as compared to CMOS design. It has the potential for attractive features such as faster speed, smaller size and low power consumption than transistor based technology. Quantum-dot cellular automata have a simple cell as the basic element. The cell is used as a building block to construct gates, wires, and memories. By taking the advantages of QCA are able to design interesting computational architectures. Unlike conventional computers in which information is transferred from one place to another by means of electrical current, QCA transfers information by propagating a polarization state. This paper proposes a detailed design and analysis of decoder circuit in Type I and Type II using quantum-dot cellular automata.

**KEYWORDS:** Quantum Dot Cellular Automata (QCA), Decoder, Majority Gate, Nanotechnology.

## I. INTRODUCTION

### II.

#### A. QCA cell

A quantum-dot cellular automata (QCA) is a square nanostructure of electron wells confining free electrons. Each cell has four quantum dots which can hold a single electron per dot. The four dots are located at the corners of the cell and only two electrons are injected into a cell. By the clocking mechanism, the electrons can tunnel through to neighboring cells during the clock transition by the interaction between electrons. A high potential barrier at the settled clock signal locks the state and results in a local polarization which is determined by Coulombic repulsion. The two electrons reside in opposite corners so that two polarizations are possible as seen in Fig. 1. Those two binary states can be used to make QCA cell[1] a storage cell, a computing cell, or a wire.

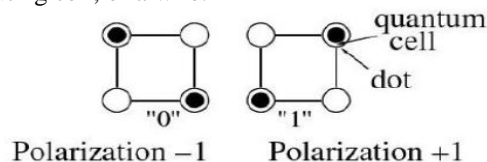

Figure.1 QCA Cell

#### B. Signal flow

A series of QCA cells act like a wire. An illustration of a QCA wire is shown in Fig. 2. During each clock cycle half of the wire is active for signal propagation, while the other half is stable. During the next clock cycle, half of the previous active clock zone is deactivated and the remaining active zone cells trigger the newly activated cells to be polarized. Thus signals propagate from one clock zone to next.

# International Journal of Innovative Research in Science, Engineering and Technology

(An ISO 3297: 2007 Certified Organization)

Vol. 4, Special Issue 6, May 2015

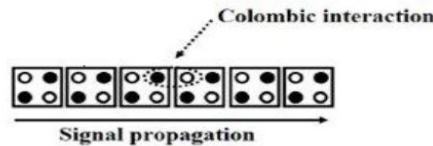

Figure.2 Signal Flow

### C.QCA Clock

The circuit area is divided into four sections and they are driven by four phase clock signals. As shown in Fig. 3, there is a 90 degree phase shift from one section to the next. In each clock zone, the clock signal has four states: high-to low, low, low-to-high, and high. The cell begins computing during the high-to-low state and holds the value during the low state. The cell is released when the clock is in the low-to-high state and inactive during the high state.

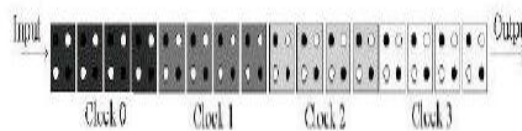

Figure.3 Clock Zones

The QCA clocking [3] signal is used to control the signal propagation along the QCA cells arrangement. There are Four-Different Clocking Phases such as „SWITCH, HOLD, RELEASE and RELAX“.

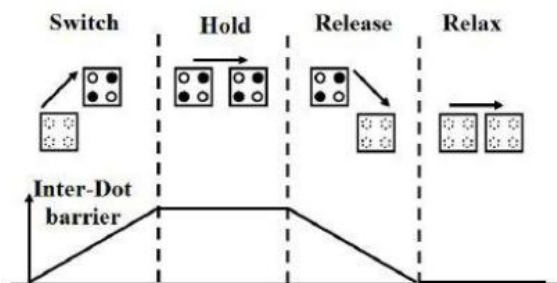

Figure.4 Clock Phase

**SWITCH:** During this phase, the inter-dot barriers are slowly raised and the computation takes place according to QCA cell arrangement.

**HOLD:** In this phase, the inter-dot barriers are kept high and the QCA cells retain their states.

**RELEASE:** During this phase, the barriers are lowered and the cells are allowed to relax to unpolarized states.

**RELAX:** The barriers are kept low and the cells remain in unpolarized state.

## II. LOGIC GATES

Logic gates[2] are required to build arithmetic circuits. In QCA, inverters and three-input majority gates serve as the fundamental gates.

### A.Majority Gate

The governing equation for the majority gate is  $M(a, b, c) = ab + bc + ca$ . Fig. 5 shows the gate symbols and their layouts. Two input AND and OR gates can be implemented with 3 input majority gates by setting one input to a constant. With ANDs, ORs, and inverters, any logic function can be realized.

# International Journal of Innovative Research in Science, Engineering and Technology

(An ISO 3297: 2007 Certified Organization)

Vol. 4, Special Issue 6, May 2015

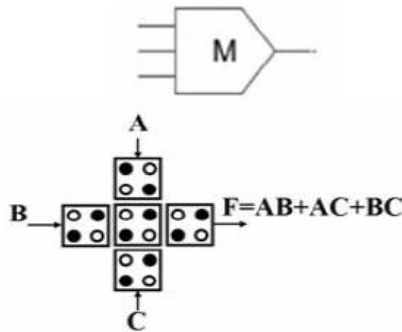

Figure.5 Majority Gate

## B. QCA Inverter

QCA Inverter can be implemented in position QCA cells to invert the output from input logic level.

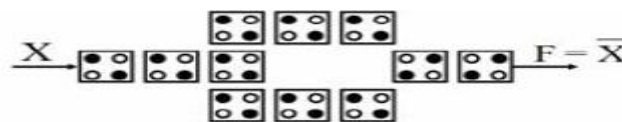
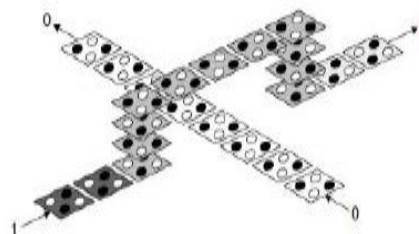

Figure.6 Inverter

### III. CROSSOVER AND MULTILAYER DESIGN

In QCA, there are two crossover options. They are coplanar crossings and multilayer crossovers. It has been believed that single layer designs are possible with QCA because of the ability to create co-planar crossovers. Coplanar crossings require using two cell types (regular and rotated). The regular cell and the rotated cell do not interact with each other when they properly aligned, so rotated cells can be used for coplanar wire crossing. They have very little mutual interaction. In the coplanar crossing, rotated cells are used when two wires cross. In a coplanar crossing, there is a possibility of a loose binding of the signal which causes a discontinuity of the signal propagation and there is the possibility of back-propagation from the far side constant input. So putting enough clock zones between the regular cells across the rotated cells is required. So the complex circuits using coplanar crossover are very likely fail. As well, the crossover is extremely sensitive to fabrication errors and depends on the ability to fabricate two types of QCA cells. Therefore is presented a solution to this Problem.



## International Journal of Innovative Research in Science, Engineering and Technology

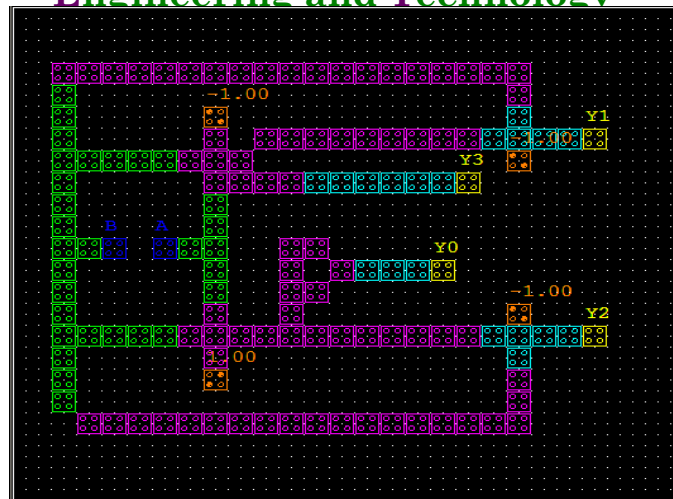

Figure.7 Multilayer design

### IV. CIRCUIT IMPLEMENTATION

The QCA Type I decoder design is shown in Fig. 8. The QCA Type II decoder design is shown in Fig. 9. The proposed QCA multiplexor has been designed and simulated using the QCA Designer [5] tool. This tool allows users to do a custom layout and then verify QCA circuit functionality by simulations. It includes two different simulation engines such as a bistable approximation and a coherence vector. The current QCA technology does not specifically set the possible operating frequency and actual propagation delays. Thus, the maximum cell count can be set as a design parameter [6].

**Type I:**

A decoder is a combinational circuit that converts binary information from  $n$  input lines to a maximum of  $2^n$  unique output lines. The QCA design of Type I decoder circuit is used to four majority gates and four inverters.

Expression of Decoder:

$$B0 = \text{majority}(x', y', 0)$$

$$B1 = \text{majority}(x', y, 0)$$

$$B2 = \text{majority}(x, y', 0)$$

$$B3 = \text{majority}(x, y, 0)$$

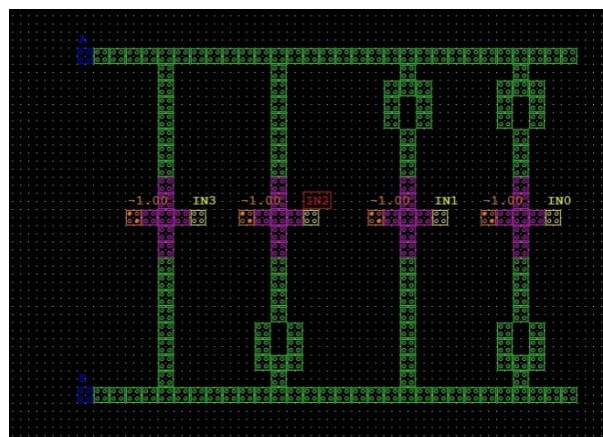

Fig.8 Type I decoder circuit

**Type II:**

The QCA design of Type II decoder circuit is used to five input majority gate and four inverters.

# International Journal of Innovative Research in Science, Engineering and Technology

(An ISO 3297: 2007 Certified Organization)

Vol. 4, Special Issue 6, May 2015

Fig.9 Type II decoder circuit

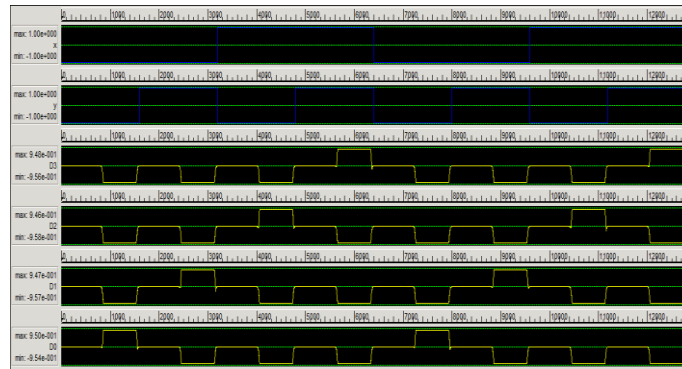

Fig.10 Simulation Output

## IV. SIMULATION

With QCA Designer ver.2.0.3, the circuit functionality is verified. The input and output waveforms are shown in Fig. 10. According to QCA Designer, this design of Type I and Type II has 114 cells and 98 cells respectively (including input and output cells) and an area of approximately  $0.13\mu\text{m}^2$  and  $0.12\mu\text{m}^2$  (each cell is  $18\text{nm}\times 18\text{nm}$ , with a  $2\text{nm}$  gap between cells).

## V. CONCLUSION

This paper presents design for QCA Type I and Type II of decoder circuits. The layout is done using QCA Designer and this design is analysed according to the complexity and area. Simulation shows that occupied area for this design is  $0.13\mu\text{m}^2$  and  $0.12\mu\text{m}^2$ . For future work, the design can be optimized in terms of complexity and the number of clock zones. Also, computation time and power consumption can be computed for designing.

## REFERENCES

1. T.Kowsalya and Dr.S.Palaniswami (2014) 'A Clock Control Strategy Based clustering Method For Peak Power And Rms Current Reduction' in Journal of Theoretical and Applied Information Technology Vol. 63 No.2 © 2005 - 2014 JATIT & LLSISSN: 1992-8645 www.jatit.org E-ISSN: 1817-3195 459
2. T.Kowsalya and Dr.S.Palaniswami(2012) 'Decoupled SRAM Cell with Bit Line Decoupled Current Mode Sense Amplifier' Published in European journal of Scientific Research in volume 84 issue 2 Aug 2012
3. A.O. Orlov, I. Amlani, G.H. Bernstein, C.S. Lent, G.L. Snider, "Realization of a Functional Cell for Quantum-Dot Cellular Automata," *Science*, Vol 277, pp 928-930, 1997.
4. P.D. Tougaw and C.S. Lent, "Logical devices implemented using quantum cellular automata," *Journal of Applied Physics*, 75:1818, 1994.J.
5. C. S. Lent and B. Isaksen, "Clocked molecular quantum-dot cellular automata," *IEEE Trans. on Electron Dev.*, 50(9): 1890– 1895, September 2003.
6. Kyosun Kim, Kaijie Wu, and Ramesh Karri, "The Robust QCA Adder Designs Using Composable QCA Building Blocks," *IEEE Trans. On Computer-Aided Design of Integrated Circuits and System*, Vol. 26, no. 1, pp. 176-183, January 2007.
7. H. Cho, E.E. Swartzlander, "Adder Designs and Analyses for Quantum-Dot Cellular Automata," *IEEE Trans. On Nanotechnology*, Vol. 6, no. 3, May 2007.
8. M.A. Amiri, M. Mahdavi, S. Mirzakuchaki, "QCA Implementation of a MUX-Based FPGA CLB", *ICONN 2008*, pp. 141–144.186
9. Moein Kianpour, Reza Sabbaghi-Nadooshan, "A Novel Design And Successful Simulation Of QCA-Based Multiplexer," Jan 2012.
10. G. Toth, C.S. Lent, "Quasiadiabatic switching for metal-island quantum dot cellular automata", *Journal of Applied Physics*, Vol. 85, Issue. 5, pp.2977–2984, 1999.