

Wind-Solar Hybrid Based Power Transfer Control of AC/DC Micro Grid Using HCC Method

D.Dharuman¹, B.Mahalakshmi², C.Thulasiyammal³

Masters Scholar, Department of EEE, The Kavery Engineering College, Mecheri, Salem, India¹

Masters Scholar, Department of EEE, Priyadarshini Engineering College, Vaniyambadi, Vellore, India²

Asst Professor, Department of EEE, The Kavery Engineering College, Mecheri, Salem, India³

ABSTRACT: This project deals about wind-solar hybrid based ac/dc micro grid to reduce the processes of multiple dc-ac-dc or ac-dc-ac conversions stage in an individual ac or dc grid. The hybrid grid consists of both ac and dc networks connected together by bidirectional converters. AC loads and storage units are connected to the ac network whereas dc source, load and energy storage units are tied to the dc network. The proposed hybrid grid can operate in a grid-tied or autonomous mode. The hysteresis based current control (HCC) algorithms are proposed for smooth power transfer between ac and dc links and for stable system operation under various generation and load conditions. Uncertainty and intermittent characteristics of wind speed, solar irradiation level, ambient temperature, and load are also considered in system control and operation. A small hybrid grid has been modeled and simulated using the Simulink in the MATLAB. The simulation results show that the system can maintain stable operation under the proposed HCC control schemes when the grid is switched from one operating condition to another.

KEYWORDS: PV ARRAY, Bidirectional converter, MPPT(Maximum Power Point Tracking).

I. INTRODUCTION

The rapid depletion of fossil-fuel resources on a worldwide basis has necessitated an urgent search for alternative energy sources of the many alternatives, photovoltaic and wind energy have been considered as promising toward meeting the continually increasing demand for energy. The wind and solar sources of energy are inexhaustible, the conversion processes are pollution-free, and their availability is free. For remote systems such as radio telecommunications, satellite earth stations, or at sites that are far away from a conventional power system, the hybrid systems have been considered as attractive and preferred alternative sources. Such systems are usually equipped with diesel generators to meet the peak load demand during short periods when there is a deficit of available energy to cover the load demand. Diesel generators need their control of operation and supply in fuel. Therefore, the cost of their usage is reasonably expensive. To eliminate the need of a diesel generator, a battery bank can be used. The configuration of a hybrid Wind/PV system is shown in Fig.1. Battery life is greatest when batteries are kept at near 100% of their capacity, or returned to that state quickly after a partial or deep discharge. The use of photovoltaic modules only does not protect batteries against deep discharges. During periods of little or no sun, the load draws more energy than the solar can replace. A more dynamic source of energy is a wind turbine by adding a wind turbine to a system would protect batteries against deep discharges and thus extend their life. For stand alone applications, storage cost still represents the major economic restraint. Combining both wind power and PV power would lead to minimizing the storage requirements, and hence the overall cost of the system. For a given load characteristic and a given wind turbine, an algorithm was developed to calculate the optimum number of solar modules and batteries that would achieve a desired Loss of Power Supply Probability. The algorithm is based upon the use of long term data for both wind speed and irradiance for the site under consideration and the energy concept. The variability in the available energy from the Wind/solar system makes it necessary to choose a right size of a battery bank that the system will satisfy the load demand at any hour of a typical day. Wind turbine and solar power output are matched to a given load demand that is a load of a typical house in Massachusetts. For every hour of a typical day in each month, power output of both a wind

International Journal of Innovative Research in Science, Engineering and Technology

(An ISO 3297: 2007 Certified Organization)

Vol. 4, Special Issue 6, May 2015

turbine and a solar Supply Probability, the combinations of a number of solar modules and a number of batteries were calculated.

The input of the converter in renewable generation can be either varied low dc voltage (like fuel cell or photovoltaic array) or ac voltage with wide variation of both amplitude and frequency (wind generator). The output of the solar PV system is dc, which can be fed to the dc load or connected to the utility through an inverter. The fluctuation nature of most renewable energy resources, like wind and solar, makes them unsuitable for standalone operation as the sole source of power.

It has many advantages such as abundance, pollution free and renewability. The voltage and current relationship is observed by maximum power point algorithm. In MPPT large number of techniques such as constant voltage tracking (CVT), the incremental conductance (INC) method, the perturb and observe method (P&O or hill climbing) method. To charge and discharge the storage element, the bidirectional dc to dc converter is used. The dc to dc converter often ensures an electrical isolation between low voltage and high voltage parts of the system and then transformer is used. Bidirectional dc to dc converter is operated in three modes of operation namely, Buck, Boost and Bidirectional.

The sinusoidal PWM method also known as triangulation; sub harmonic method is very popular in industrial application. In this modulation techniques are multiple numbers of output pulse per half cycle and pulses are of different width. The width of the each pulse is varying in proportion to amplitude of the sine wave evaluated at the center of the same pulse. The gating signals are generated by comparing the sinusoidal reference with a high frequency triangular signal. This technique is called sinusoidal pulse width modulation (SPWM) mainly used because of its simplicity and ease of implementation. The output voltage magnitude is controlled by closed loop control system using PI controller.

The algorithm was verified with MATLAB-SIMULINK that it can track the real MPP very fast when the temperature changes. The closed loop operation of proposed system is verified with MATLAB simulations including load and source disturbances.

II. PROPOSED SYSTEM CONFIGURATION

A. BLOCK DIAGRAM

This block diagram consists of solar PV array, wind system, boost converter, bidirectional DC to DC converter and loads.

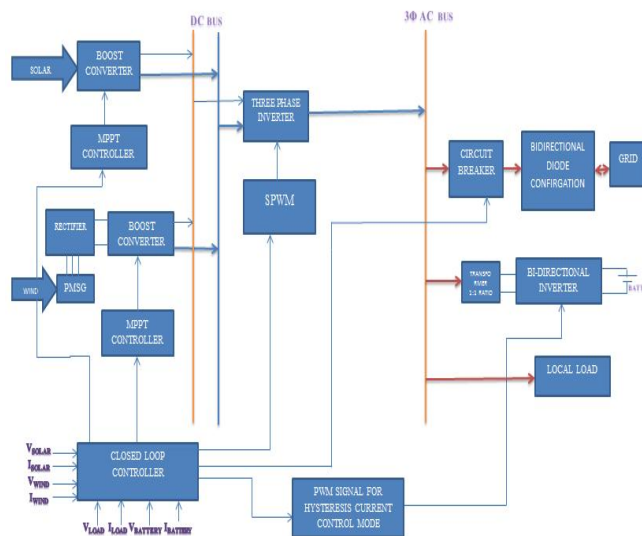

Fig 1: Block diagram of proposed system

International Journal of Innovative Research in Science, Engineering and Technology

(An ISO 3297: 2007 Certified Organization)

Vol. 4, Special Issue 6, May 2015

The Hybrid system that the generated power is given to DC bus after DC is converted into AC by using 3 phase inverter and it's integrated with grid and battery. In AC bus it has connected different loads. The system has several advantages, 1) Improve efficiency, Reliability, Fast dynamic response. 2) The overload power is supplied to the grid. 3) To introduce bidirectional converter for power flow capability for energy management.

B. MAXIMUM POWER POINT TRACKING

The maximum power point tracking is achieved with the help of DC-DC converter interfaced between the solar PV module and the load. The automatic tracking of the MPP can be achieved by utilizing various MPPT algorithms. These algorithms can be implemented in digital controller to track the maximum power from the solar PV module. The algorithm adjusts the duty cycle of the DC-DC converter and makes it to operate at the peak power point of the solar PV module under different environmental conditions. The Hill climbing or perturb and observe (P&O) method and incremental conductance (Inc Cond) method are the most popular and recommended MPPT algorithms.

C. Modified Perturb and Observe

The MPPT algorithms based on hill top or P&O algorithm is more popular because of its simplicity and ease in implementation. However oscillation problem is unavoidable in these algorithms. The INC algorithm is able to track the MPP under rapidly changing environmental changes, but the major disadvantage of this algorithm is the increased complexity as compared to conventional P&O algorithm. Therefore the hill-top algorithm is modified such that it gives better response during the transients and rapidly varying atmospheric conditions.

As shown in Figure, if change in power ΔP is positive, the operating point is expected to move closer to the MPP. Thus a further voltage perturbation is added in the operating voltage that leads to the movement of operating point in the same direction towards the MPP. If ΔP is negative, the operating point has moved away from the MPP, and the direction of perturbation is reversed to move it back toward the MPP.

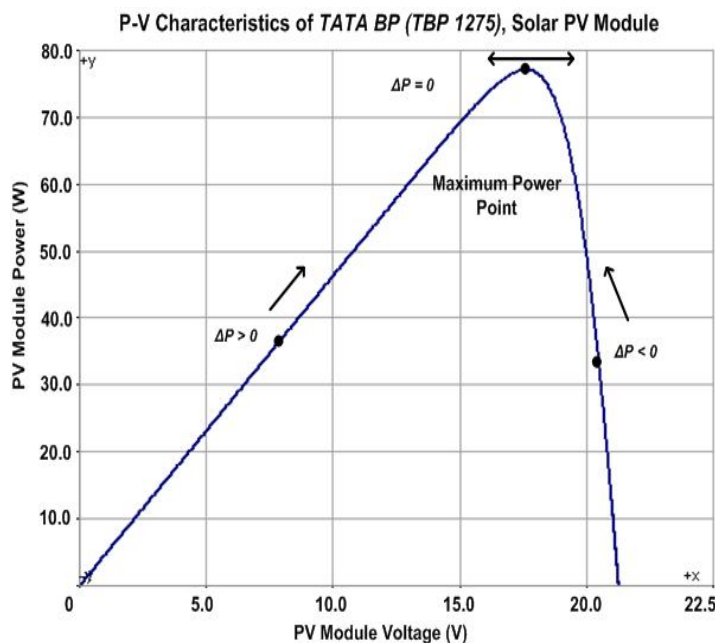

Fig 2: P-V characteristics of solar PV module with hill climbing operation.

The conventional P & O algorithm a small perturbation in the voltage is introduced to change the power of the solar PV module. But this algorithm fails to act under fast varying atmospheric conditions. The modified hill top algorithm gives better performance during rapid changes in the atmospheric and sudden changes in the load.

International Journal of Innovative Research in Science, Engineering and Technology

(An ISO 3297: 2007 Certified Organization)

Vol. 4, Special Issue 6, May 2015

In the modified hill top algorithm proposed in this section two tolerance limits are chosen, one is larger and other is smaller. For a large change in conditions, a large change in duty cycle is used while for smaller change a small change in duty cycle is used. This modification in the hill top algorithm makes the maximum power point tracking technique to give better response during sudden change in load conditions and rapid changes in the atmospheric conditions. The flow chart of the modified hill climbing algorithm is shown in Figure.

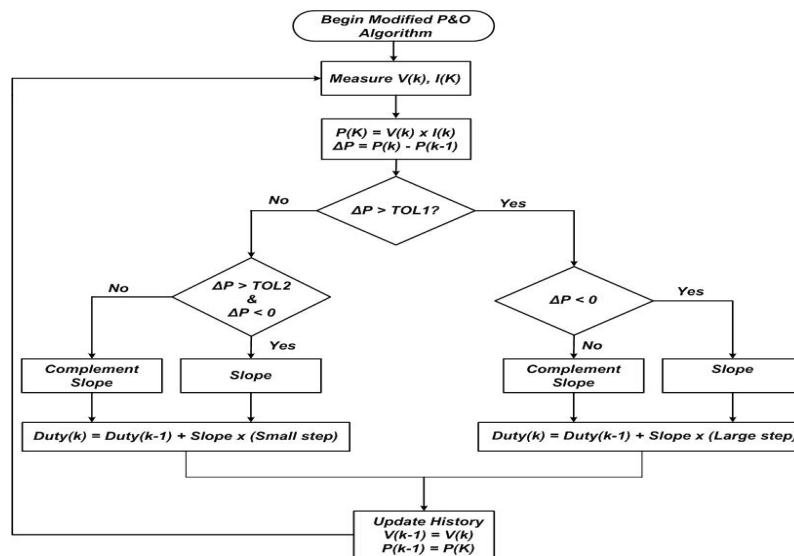

Fig 3: Flowchart of modified hill climbing algorithm

4. Modes of operation

The operation of the charging station can be categorized into four modes: Mode-1, Mode-2, Mode-3, Mode-4, Mode 5, Mode 6

The six modes of operation are described as follows:

Mode-1

In this mode the Hybrid systems generate all the power required to operate the loads. As the distribution transformer is not over load the PV systems need not deliver any power to the grid.

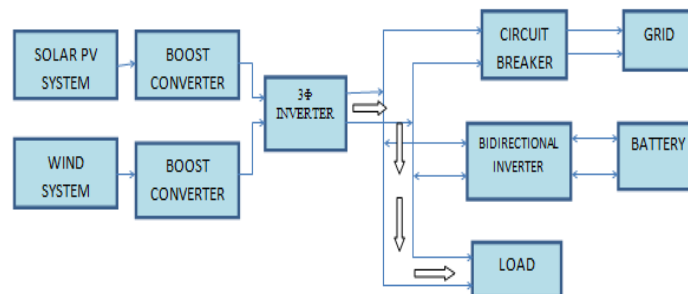

Mode 2

This mode operate the Hybrid system generate excess power once the dc link voltage exceeds the required voltage. This additional power generated by the Hybrid system is sent to the battery by using bidirectional converter

International Journal of Innovative Research in Science, Engineering and Technology

(An ISO 3297: 2007 Certified Organization)

Vol. 4, Special Issue 6, May 2015

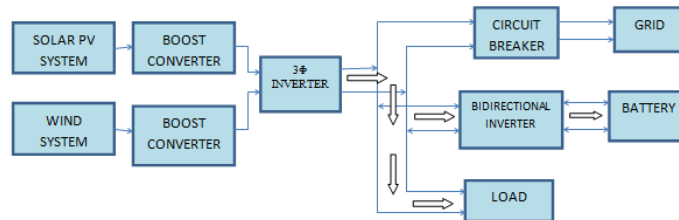

Mode 3:

This mode operate the PV array generate excess power once the dc link voltage exceeds the required voltage. This additional power generated by the hybrid system is sent to the grid, once the battery is fully charged otherwise it's given to the battery.

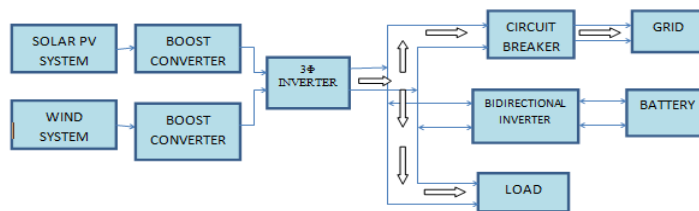

Mode 4:

This mode operates the Hybrid system generate excess power once the dc link voltage exceeds the required voltage shown in figure 8. This additional power generated by the Hybrid system is sent to the grid when the battery is fully charged and load power is enough to operate the local loads then only its send to the grid

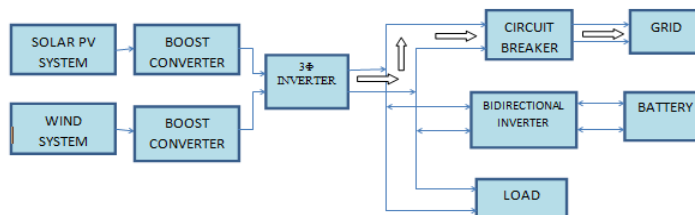

Mode 5:

In this mode the solar and wind system does not generate any power due to bad weather conditions or low radiation and low wind speeds condition.

The power is required to operate the induction motor a .so the battery supplies the power to the load by using bidirectional converter.

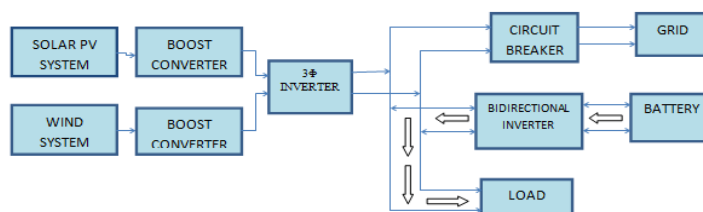

International Journal of Innovative Research in Science, Engineering and Technology

(An ISO 3297: 2007 Certified Organization)

Vol. 4, Special Issue 6, May 2015

Mode 6:

In this mode the power generated by the Hybrid system is less than the power required to the loads. Therefore all the power generated by the hybrid system is transferred to the load and the deficit is supplied by the battery. The dc link voltage varies with the change in irradiation and air flow condition

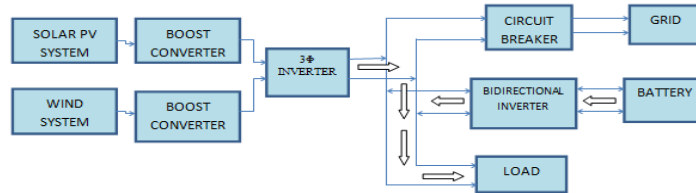

IV SIMULATION DIAGRAM

A. Solar system

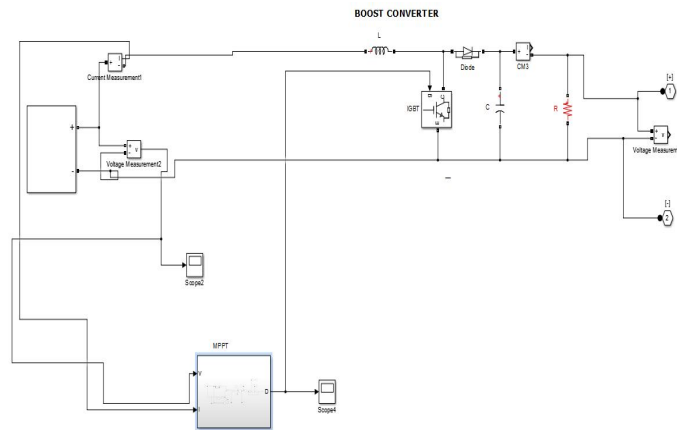

Fig 3: Simulation diagram of solar system

B. Wind system

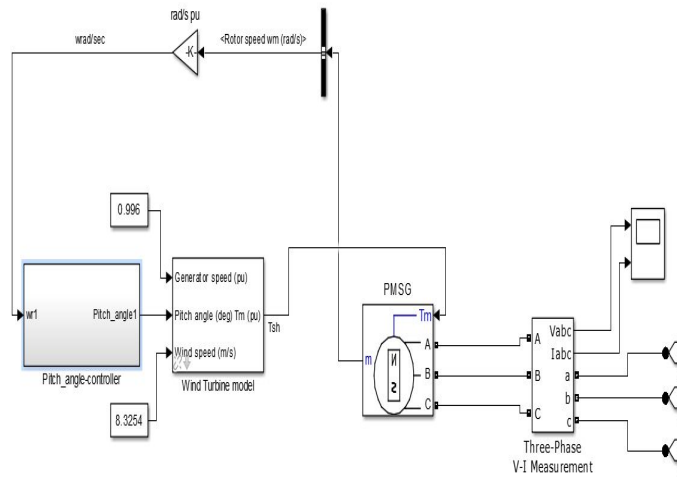

Fig 4: Simulation diagram of wind system

International Journal of Innovative Research in Science, Engineering and Technology

(An ISO 3297: 2007 Certified Organization)

Vol. 4, Special Issue 6, May 2015

C. Bidirectional converter

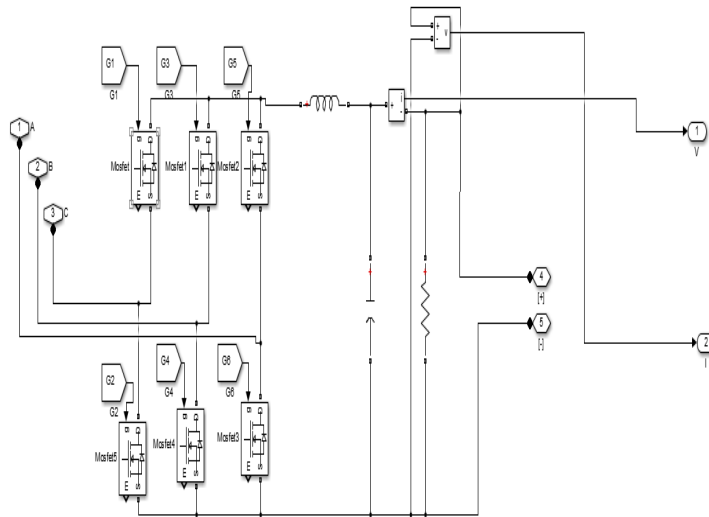

Fig 5: Simulation diagram of Bidirectional converter

C. Full circuit

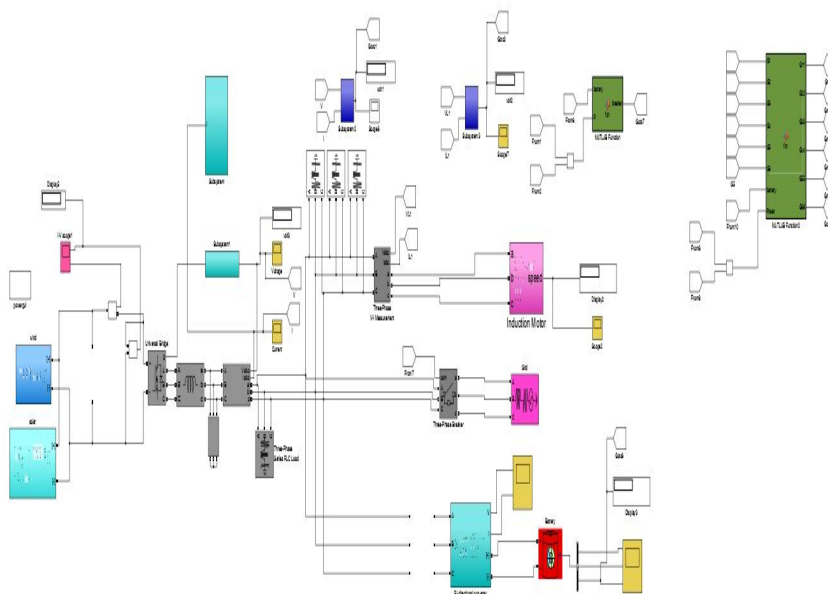

Fig 6: simulation diagram of proposed system

International Journal of Innovative Research in Science, Engineering and Technology

(An ISO 3297: 2007 Certified Organization)

Vol. 4, Special Issue 6, May 2015

V. SIMULATION RESULTS

A. Solar PV output

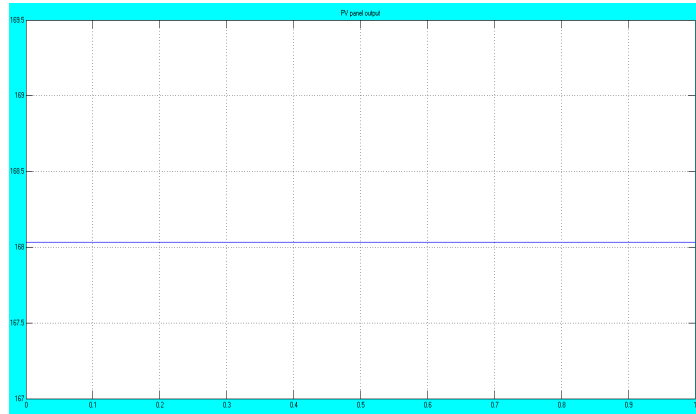

Fig 7: Simulation result for solar PV output

B. Boost converter

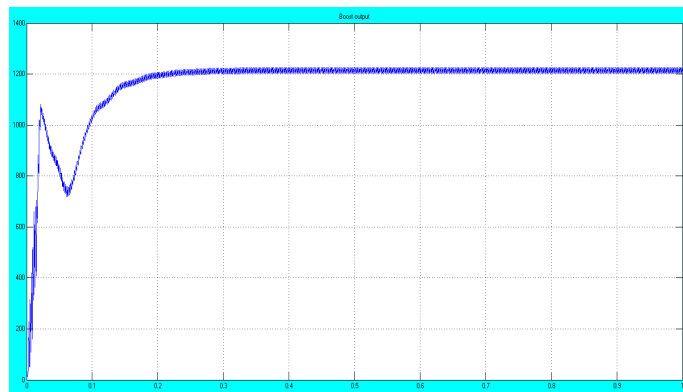

Fig 8: Simulation result for boost converter

C. Induction motor speed

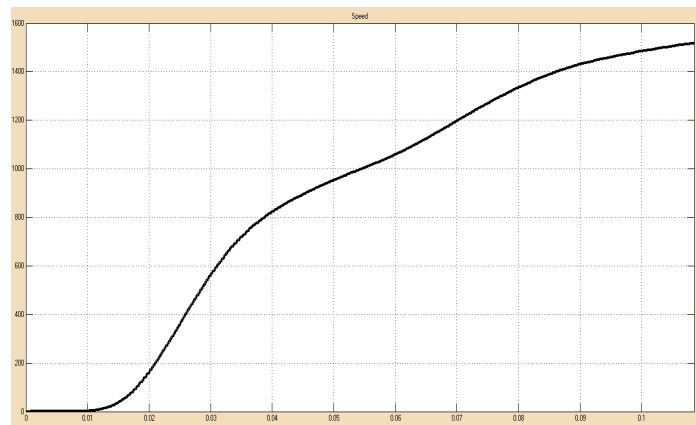

Fig 9: simulation result for induction motor speed

International Journal of Innovative Research in Science, Engineering and Technology

(An ISO 3297: 2007 Certified Organization)

Vol. 4, Special Issue 6, May 2015

D. State of charge

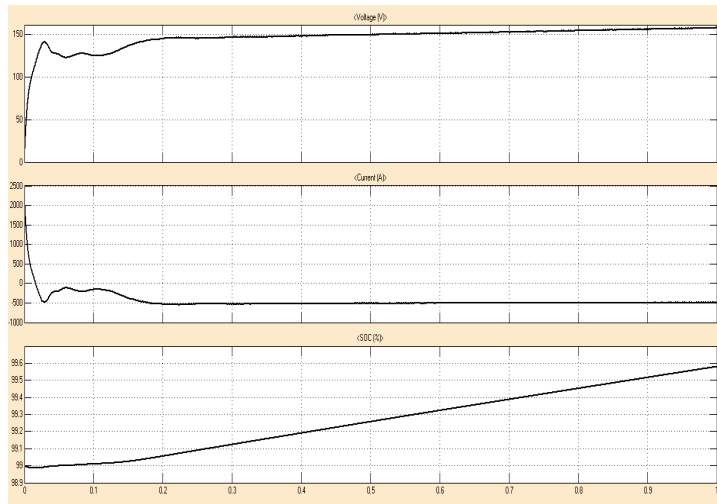

Fig 10: Simulation result for SOC

E. Bidirectional voltage & current

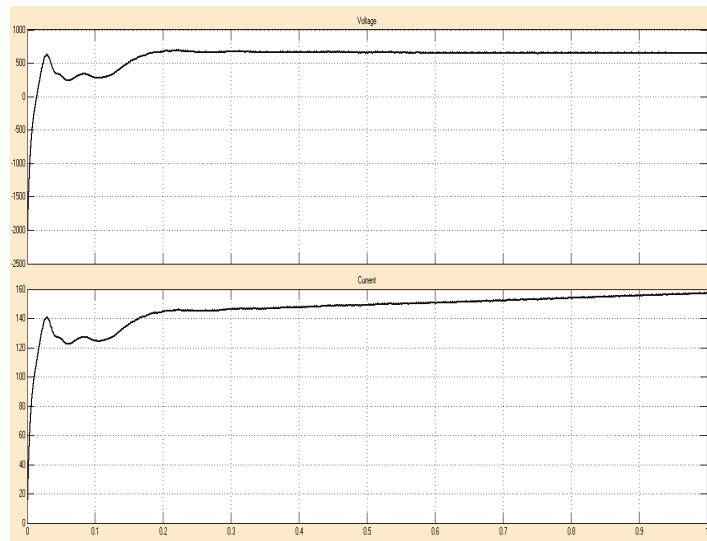

Fig 11: Simulation result for voltage & current

F. Grid voltage

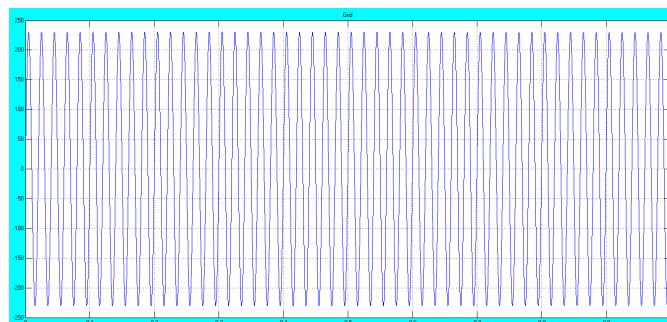

Fig 12: Simulation result for grid voltage

International Journal of Innovative Research in Science, Engineering and Technology

(An ISO 3297: 2007 Certified Organization)

Vol. 4, Special Issue 6, May 2015

VI. CONCLUSION

In this work, the importance of hysteresis current control based grid connected PV system has been highlighted. A bidirectional topology with improved features has been proposed. Relevant analysis, including derivations of the expressions for peak voltage and current stresses across the switching devices, has been performed and a design procedure has been presented. The topology is simple, symmetrical and easy to control. The other desirable features include good efficiency due to optimal number of device switching and reduced switching losses. The diodes which are inherent to the inverter operation, also serve to prevent any reverse power flow from the power grid to the Hybrid system. HCC operation ensures better control apart from facilitating the generation and feeding of high quality current into the grid. The grid current THD is less than 5% with a good grid voltage waveform (closer to a pure sine wave), the THD can be limited as per IEEE-519 (current THD 5%) and the topology will be able to feed high quality current into the grid.

REFERENCES

1. W. L. Yu, T.-P. Lee, G.-H. Wu, Q. S. Chen, H.-J. Chiu, Y.-K. Lo, and F. Shih, "A DSP-based single-stage maximum power point tracking PV Inverter," in *Proc. APEC*, vol. 25, pp. 948–952, 2010.
2. F. Coelho, F. M. Concer, and D. C. Martins, "A MPPT approach based on temperature measurements applied in PV systems," in *Proc. IEEE ICSET*, pp. 1–6, 2010.
3. C. Hamilton, G. Gamboa, J. Elmes, R. Kerley, A. Arias, M. Pepper, J. Shen, and I. Batarseh, "System architecture of a modular direct-DC PV charging station for plug-in electric vehicles," in *Proc. IECON 2010 36th Annu. Conf. IEEE Ind. Electron. Soc.*, Nov. 7–10, 2010, pp. 2516–2520.
4. J. M. Guerrero, "A distributed control strategy based on dc bus signaling for modular photovoltaic generation systems with battery energy storage," *IEEE Trans. Power Electron.*, vol. 26, no. 10, pp. 3032–3045, 2011.
5. S. W. Hadley, "Evaluating the impact of plug-in hybrid electric vehicles on regional electricity supplies," in *Proc. IREP Symp. Bulk Power Syst. Dyn. Control—VII. Revitalizing Operational Reliability*, Aug. 19–24, 2007, pp. 1–12. 1428 *IEEE TRANSACTIONS ON SMART GRID*, VOL. 5, NO. 3, MAY 2014.
6. Jordi Everts, Member, IEEE, Florian Krismer, Member, IEEE, Jeroen Van den Keybus, Johan Driesen, Senior Member, IEEE, and Johann W. Kolar, Fellow, IEEE "Optimal zvs modulation of single-phase single-stage bidirectional DAB AC–DC converters" *IEEE Transactions on Power Electronics*, vol. 29, no. 8, August 2014.
7. Biao Zhao, Student Member, IEEE, Qiang Song, Wenhua Liu, and Yandong Sun "A synthetic discrete design methodology of high-frequency isolated bidirectional dc/dc converter for grid-connected battery energy storage system using advanced components" *IEEE Transactions on Industrial Electronics*, vol. 61, no. 10, October 2014.
8. Moacyr Aureliano Gomes de Brito, Luigi Galotto, Jr., Leonardo Poltronieri Sampaio, Guilherme de Azevedo Melo, and Carlos Alberto Canesin, Senior Member, IEEE "Evaluation of the main mppt techniques for photovoltaic applications" *IEEE Transactions on Industrial Electronics*, vol. 60, no. 3, March 2013.
9. M. F. Ansari, S. Chatterji, and A. Iqbal, "A fuzzy logic control scheme for a solar photovoltaic system for a maximum power point tracker," *Int. J. Sustainable Energy*, vol. 29, no. 4, pp. 245–255, 2010.
10. S. Brunton, C. Rowley, S. Kulkarni, and C. Clarkson, "Maximum power point tracking for photovoltaic optimization using ripple-based extremum seeking control," *IEEE Trans. Power Electron.*, vol. 25, no. 10, pp. 2531–2540, Oct. 2010.
11. A. Virtuani and H.M'ullejans, E. Dunlop, "Comparison of indoor and outdoor performance measurements of recent commercially available solar modules," *Prog. Photovoltaics: Res. Appl.*, vol. 19, pp. 11–20, 2011.
12. E. Koutroulis and F. Blaabjerg, "A new technique for tracking the global maximum power point of PV arrays operating under partial-shading conditions," *IEEE J. Photovoltaics*, vol. 2, no. 2, pp. 184–190, Apr. 2012.
13. Uwe Zimmermann, Member, IEEE, and Marika Edoff A Maximum Power Point Tracker for Long-Term Logging of PV Module Performance *IEEE JOURNAL OF PHOTOVOLTAICS*, VOL. 2, NO. 1, JANUARY 2012 pp. 47-55
14. Vivek Agarwal, Rakesh K. Aggarwal, Pravin Patidar, and Chetan Patki., "A Novel Scheme for Rapid Tracking of Maximum Power Point in Wind Energy Generation Systems," *IEEE Transactions On Energy Conversion*, Vol. 25, No. 1, March 2010
15. Zakariya M. Dalala, Zaka Ullah Zahid, Wensong Yu, Younghoon Cho and Jih-Sheng (Jason) Lai, "Design and Analysis of an MPPT Technique for Small-Scale Wind Energy Conversion Systems," *IEEE Transactions On Energy Conversion*, Vol. 28, No. 3, Sept. 2013
16. T. R. Mtshali, G. Coppez, S. Chowdhury and S.P. Chowdhury, "Simulation and Modelling of PV-Wind-Battery Hybrid Power System," *IEEE Power and Energy Society General Meeting*, 2011
17. Chunhua Liu, K. T. Chau and Xiaodong Zhang, "An Efficient Wind-Photovoltaic Hybrid Generation System Using Doubly Excited Permanent-Magnet Brushless Machine," *IEEE Transactions On Industrial Electronics*, Vol. 57, No. 3, March 2010
18. Yukihiro Ozaki, Masafumi Miyatake and Daisuke Iwaki, "Power Control of a Stand-alone Photovoltaic/ Wind/ Energy Storage Hybrid Generation System with Maximum Power Point Tracker," *ICEMS 2010* Page(s): 607 - 611