

International Journal of Innovative Research in Science, Engineering and Technology

(An ISO 3297: 2007 Certified Organization)

Vol. 4, Special Issue 6, May 2015

Fault Analysis of Underground Cables with Magnetic Shield Using Finite Element Analysis and artificial intelligence

Ch V N S PavanPushya, Dr.A.Rathinam

P.G. Student, Department of Electrical and Electronics Engineering, SRM University , Chennai , India

Associate Professor, Department of Electrical and Electronics Engineering, SRM University, Chennai , India

Abstract: In any transmission system overhead and underground medium can be used for transmission of power. The distribution of power in the transmission system is most efficient with low losses at high voltage levels. At lower voltage levels underground is most efficient with reduced losses compared to overhead. The very problem with underground system is for any abrupt or abnormal condition it is highly difficult to type of disturbance. In order to identify and analyses whether it is a fault or disturbance a magnetic shield is inserted with underground system in order to improve the performance and identify the type of fault. The faults are identified using the calibration of shield dimensions and highest values of the currents are calculated using genetic and chaotic algorithms

Keywords: Transmission and distribution networks, Overhead transmission lines, underground cables, faults, shields, electromagnetic field theory.

I. INTRODUCTION

In this mechanized and modernized world electric power system has been enhanced a lot at different levels. The overhead transmission and distribution systems acts intermediate link between generation and loads, which contributes for 26% to 30 % of total losses and may affect the power systems performance adversely. Overhead systems are efficient for high voltages ranging from 66 KV to 765 KV. Whereas for the distribution network the overhead transmission system lacks sufficient right of way and becomes complex and further at the load end the conversion of radial to mesh takes place and increases the losses significantly. So in order to overcome this situation the utilization end can be modeled using underground cables where in the right of way doesn't play a major role, internal capacitance is greater than inductance results in suppression of electromagnetic interference.

Underground cables have achieved greater predominance because of their reduced losses. But the very problem is to analyze the behavior of the cables under fault conditions. Fault is defined as the disturbance which affects the performance of the systems abnormally. In this paper a concept called magnetic shield is considered and finite elemental analysis is performed to evaluate stress and strain.

II. TYPES OF MAGNETIC SHIELDS

Basically magnetic shields are classified based on type of source [1]

- a. Active Shield

International Journal of Innovative Research in Science, Engineering and Technology

(An ISO 3297: 2007 Certified Organization)

Vol. 4, Special Issue 6, May 2015

b. Passive Shield

and on type of material used

- a. Ferromagnetic
- b. Paramagnetic
- c. Diamagnetic

Here ferromagnetic material are considered of cylindrical in nature placed near junctions is considered themagnetic flux density due to conductor at point T in the direction of ψ given by [2]

$$B(T) = \frac{\mu_0 I}{4\pi\rho} (\cos\alpha_1 - \cos\alpha_2) \tag{1}$$

For simple shield geometry two dimensional modeling of the problem is sufficient, Cartesian coordinates can be used to model the long structures. Three dimension modeling must use at the edges of the structures (Cables, planner shields and bus bars). When active and passive shields are placedtogether in the transmission lines of conductive σ , the current density and electrical field are related by [2]

$$J = \sigma E \tag{2}$$

Quasistatic magnetic fields are to be modeled by multilayering with high magnetic permeability, high electric conductivity or both. The governing equations for vector of magnetic field \bar{H} and \bar{E} in a quasi-static [2] system are

$$\nabla \times \bar{H} = \bar{J} \tag{3}$$

$$\nabla \times \bar{E} = -j\omega\mu\bar{H} \tag{4}$$

$$\bar{E} = -j\omega\bar{A} \tag{5}$$

Where

\bar{A} Is magnetic vector potential

$$B = \mu H = \nabla \times \bar{A} \tag{6}$$

The ratio between the resultant field after implementation [2] of sheading and before implementation of sheading

$$f_s = \frac{|\bar{B}_z|}{|\bar{B}_0|} \tag{7}$$

A smaller shielding factor f_s means better magnetic fields reduction. Sheading factor above 1 means there is enhancement of magnetic fields and vice versa. Considering a three phase underground cable with balanced systems maintains balanced current under normal operating conditions and the current level increment to higher values under fault condition indicating

International Journal of Innovative Research in Science, Engineering and Technology

(An ISO 3297: 2007 Certified Organization)

Vol. 4, Special Issue 6, May 2015

the enhancement or reduction of magnetic fields. In order to clearly analyze the effect on shields finite elemental analysis is applied.

III. FINITE ELEMENTAL METHODS

The name finite elemental analysis [3] itself is self-explanatory that the analysis is done on a finite element of the object. When considered a small finite element and performed stress analysis the behavior of that particular element will be reflected on the whole object. By implementation of this method mechanical analysis (force acting on particular point on the object) can be done easily. Mechanically while applying FEM the element behavior is observed between local axis and global axis. Whereas in electrical system the element behavior is analyzed between voltage and current, thus giving raises to the variation in potential energy. For the ease of detection in variation of physical properties, the shield material is modeled as the combination of resistance and inductance as shown below [2].

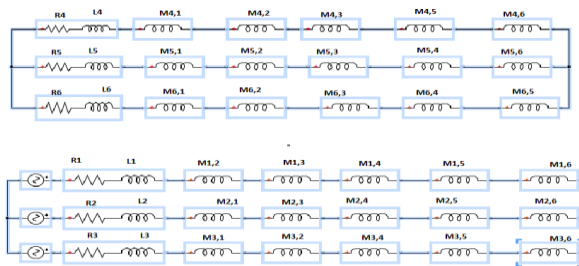

Figure a: Magnetic Shield

Thus when the current passes through the shield material, it can apply resistant force against the force due to magnetic interference which is evident that shield material will experience stress or strain at fault location due to variation of fault current. Before the FEM is applied it is assumed that the object is sectioned in both x and y direction. The nodal displacement of each point is considered to be same. Thus the possibility to use the virtual displacement will be more. The displacement function can be chosen in the following form [4].

$$U = C_0 + C_1 x \tag{8}$$

Applying the boundary conditions we have

$$U_1 = C_0 \text{ and } U_2 = C_0 + C_1 l \tag{9}$$

$$\text{Thus } C_0 = U_1 \text{ and } C_1 = \frac{U_2 - U_1}{l} \tag{10}$$

Then the displacement function for the single finite element can be written as

$$U = U_1 + \frac{U_2 - U_1}{l} x \tag{11}$$

International Journal of Innovative Research in Science, Engineering and Technology

(An ISO 3297: 2007 Certified Organization)

Vol. 4, Special Issue 6, May 2015

$$U = U_1 \left(1 - \frac{x}{l}\right) + U_2 \frac{x}{l} \quad (12)$$

$$U = U_1 N_1(x) + U_2 N_2(x) \quad (13)$$

$N_1(x) = 1 - \frac{x}{l}$ and $N_2(x) = \frac{x}{l}$ are known as nodal functions.

Thus the potential energy experienced by the element is given by

$$PE = \frac{1}{2} [U_1 \quad U_2] \begin{bmatrix} K_{11} & K_{12} \\ K_{21} & K_{22} \end{bmatrix} \begin{bmatrix} U_1 \\ U_2 \end{bmatrix} - [U_1 \quad U_2] \begin{bmatrix} F_m \\ F_e \end{bmatrix}$$

Where F matrix represents the magnetic force and electric force experienced by the element.

VI. OPTIMIZATION ALGORITHMS

Generally optimization algorithms [5] are mainly applied to linear problems where the actual variables are originally formulated. Considering for instance a genetic algorithms where the characters that are determined at the genetic level by the way the parent chromosomes combine. In general populations of strings are used and are often referred as chromosomes and often simple analogies of genetic crossover and mutation are performed for each string in the population evaluated and the objective function is optimized. These are easily applicable for normal electrical systems. The very problem with linear algorithms is that some garbage bits at the coding positions gets attached to the strings to the optimal values and gets selected more often called hitch hiking bits. To overcome this effect chaotic optimization algorithm [6] is introduced which is nonlinear phenomenon and widely known for its dynamic properties namely ergodicity, intrinsic stochastic properties sensitive dependence on initial conditions. These factors accelerate the optimum seeking operation and find the global optimal solution.

V. RESULTS AND DISCUSSION

For the proper analysis and study regarding the faults on underground cables a proto type system has been considered consisting of both overhead transmission line and underground transmission line. In the below diagram a 400 KV line transmission line has been considered and shown how it is distributed in different load type. Here the distribution end is considered that the transmission has been done with the underground cabling system. Matlab/Simulink simulations are carried out for the analysis of the system.

International Journal of Innovative Research in Science, Engineering and Technology

(An ISO 3297: 2007 Certified Organization)

Vol. 4, Special Issue 6, May 2015

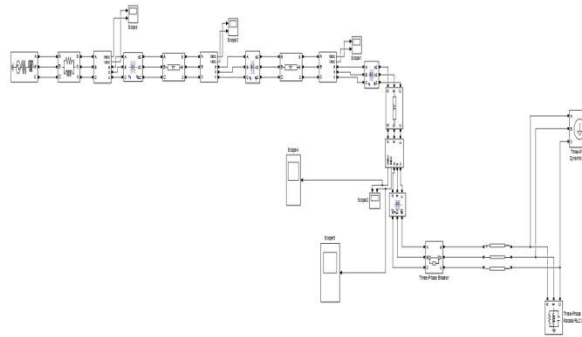

Figure b: System without Fault

The above system is system with no fault. For such system the voltage and current should be constant through the system.

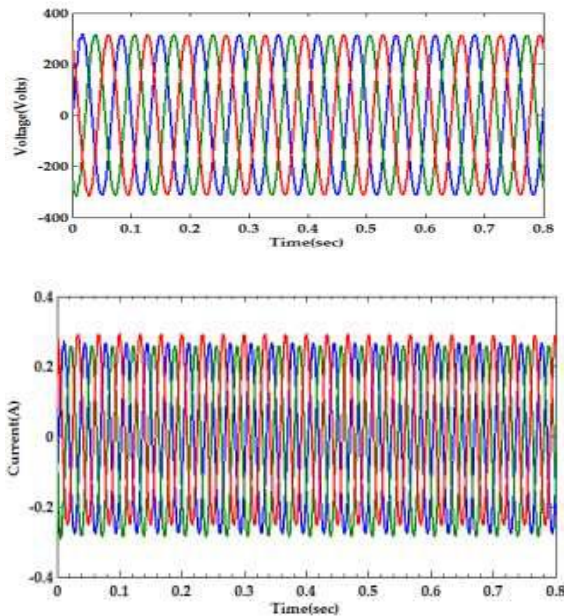

Figure c: Voltage and Current Waveforms for normal System

Now when there is fault is introduced in the system there will be clear noticeable variation on voltage and current. Now when LG fault [6] is introduced in the system,

International Journal of Innovative Research in Science, Engineering and Technology

(An ISO 3297: 2007 Certified Organization)

Vol. 4, Special Issue 6, May 2015

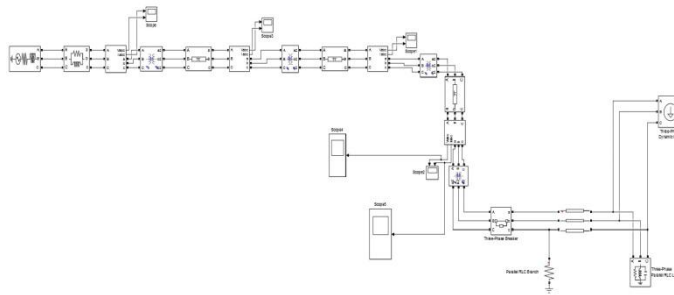

Figure d: System with LG Fault

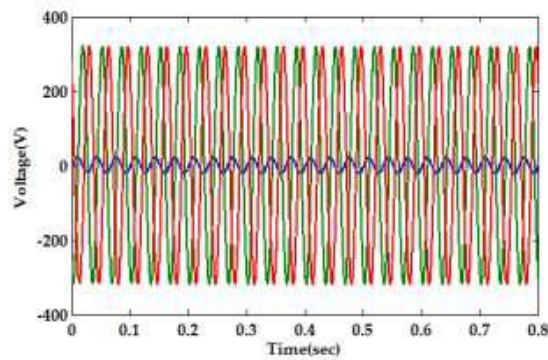

Figure e: Voltage Waveforms during LG Fault

From the voltage waveforms it is clearly visible; the phase which is shorted with the ground has been dipped to almost to zero.

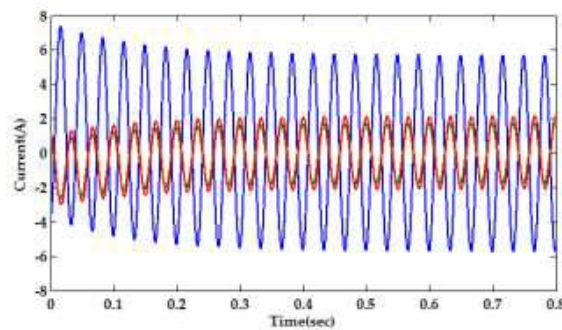

Figure f: Current Waveforms during LG fault

The phase which is grounded, there is hike in the current in system which is evident that it's a fault current.

International Journal of Innovative Research in Science, Engineering and Technology

(An ISO 3297: 2007 Certified Organization)

Vol. 4, Special Issue 6, May 2015

Now when LL fault is considered

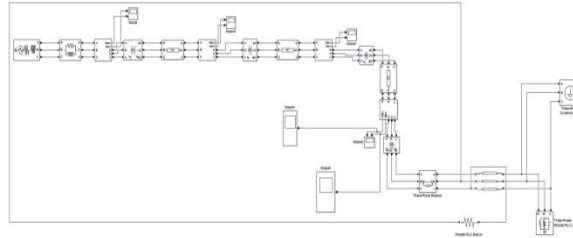

Figure g: System with LL fault

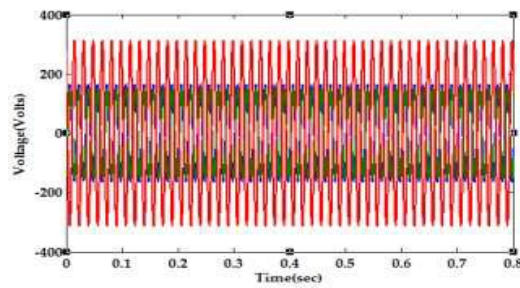

Figure h: Fault Voltage during LL fault

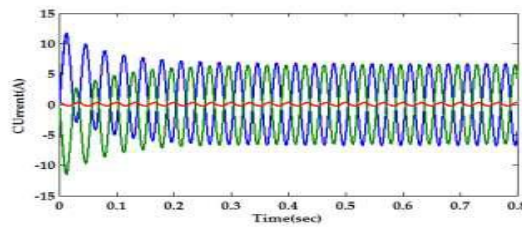

Figure i: Current Waveforms during LL fault

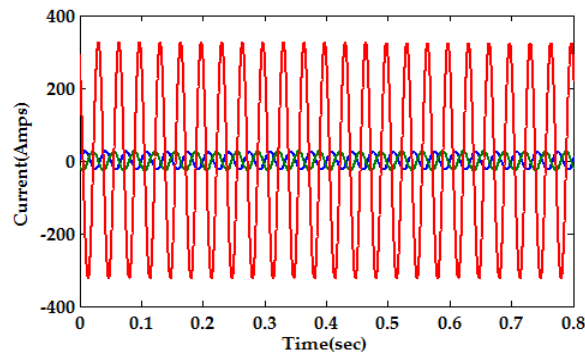

Figure j: Voltage during LLG Fault

International Journal of Innovative Research in Science, Engineering and Technology

(An ISO 3297: 2007 Certified Organization)

Vol. 4, Special Issue 6, May 2015

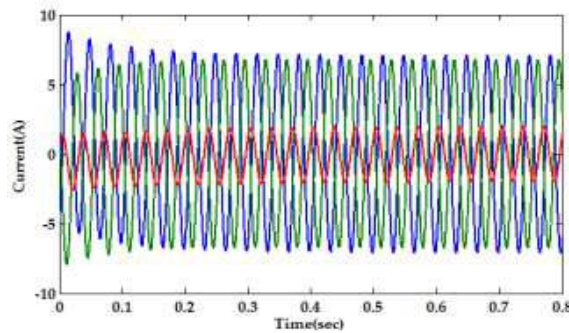

Figure k: Current during LLG fault

The wave forms whatever were display in overhead system. Now taking these as reference underground cables will be designed. When finite elemental analysis is applied on a normal system the potential energy was constant throughout the cable. Now when any fault occurs then there will be variation in the potential energy

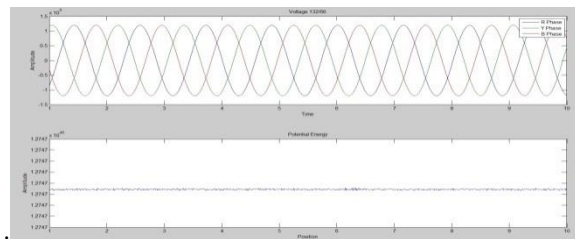

Figure l: Potential Energy Distribution during Normal Condition in the Shield

The above graph shows that potential energy distribution along the shield and which is constant thought out. Thus during this condition shield will not apply any restraining force and there won't be any change in physical dimensions of the shield.

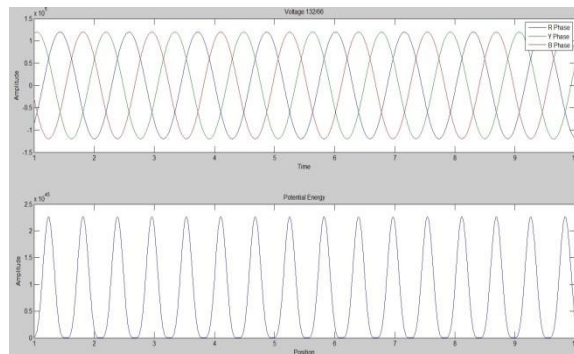

Figure m: Potential Energy Distribution during Fault Condition

Now when there is fault is introduced in the cable system the potential energy distribution is not constant. This variation is enough for shield to change its physical properties.

International Journal of Innovative Research in Science, Engineering and Technology

(An ISO 3297: 2007 Certified Organization)

Vol. 4, Special Issue 6, May 2015

Table 1: Comparison between FEM and Chaotic Optimizations with respect to shield Fault currents

| Sno | FEM SC in KA | Chaotic GA KA |
|-----|--------------|---------------|
| 1 | 380.16 | 418.52 |
| 2 | 352.718 | 351.58 |
| 3 | 321.3235 | 315.97 |
| 4 | 267.3519 | 289.08 |
| 5 | 153.1727 | 174.39 |

VI. CONCLUSIONS

Magnetic shields can be one of the optimal protecting equipment with lower in cost that can be best utilized to find the underground faults of the system and it has been found that by finite element method and chaotic optimization algorithms are almost yielding the same results indicating that the fem on small object reflecting the entire performance of the shield.

REFERENCES

- [1]. Juan Carlos del PinoLópez and Pedro Cruz Romero” A Comparative Analysis of Passive Loop-Based Magnetic Field Mitigation of Overhead Lines”
- [2]. M Istenit, P Kokelj, P hnko,BCestnik,Tiivic, “SOME ASPECTS OF MAGNETIC SHIELDING OF A TRANSFORMER SUBSTATION USING ALTERNATIVE SHIELDING TECHNIQUES”
- [3]. A book on “Introduction to the Finite Element Method ” By EvgenyBarkanov
- [4]. A textbook on “MATLAB codes Finite Elemental Analysis” by A.J.M Ferreira
- [5]. “Magnetic Field Shielding optimization in Underground Power Cable Duct Banks ”juan Carlos del-Pino-Lopeza, Pedro Cruz Romeroa, Luis Serrano, Iribarnegarayb, Javier Maiteinez- Roman
- [6]. Reza Ebrahimzadeh , Mahdi Jampour “Chaotic Genetoc Algorithm based on Lorenz Chaotic System for Optimization Problems”
- [7]. A text book on “Modern Power Systems Analysis” by D.P. Kothari, J. Nagarith Fourth Edition McGraw Hill Publications
- [8]. Ronny Stolan “Losses and Inductive Parameters in Subsea Power Cables”
- [9]. Overhead line data from cea.gov.in
- [10]. Cable Data from Oman Industries