

## International Journal of Innovative Research in Science, Engineering and Technology

(An ISO 3297: 2007 Certified Organization)

Vol. 4, Special Issue 6, May 2015

# Power Quality Improvement Using Multi Level Inverter Operated In Grid Connected Mode

<sup>1</sup>Dr.C.Nagarajan, <sup>2</sup>G.Neelakrishnan, <sup>3</sup>P.Ganeshkumar, <sup>3</sup>D.Vinoth

<sup>1</sup>Professor, Department of EEE, Muthayammal College of Engineering, Rasipuram, Tamilnadu, India

<sup>2</sup>Assistant Professor, Department of EEE, Muthayammal College of Engineering, Rasipuram, Tamilnadu, India

<sup>3</sup>PG Scholar, Department of EEE, Muthayammal College of Engineering, Rasipuram, Tamilnadu, India

**ABSTRACT:** Micro grid is an independent and controllable system which is composed by load and miniature power. It provides for the local power and energy. The complex control of micro grid is implemented by micro grid inverter. This paper introduces two operation modes one is Grid-connected and another one is Grid-disconnected for micro grid inverter. On the Grid-connected operation, it uses hysteresis current tracking, by adjusting the output current to the grid to achieve energy transmission. On the Grid-disconnected operation, it uses voltage close loop control, by adjusting the output voltage to ensure stable load voltage. When the grid fails or recovers, micro grid inverter can switch smoothly between two modes of Grid-connected and Grid-disconnected operations. The simulation results show the feasibility and effectiveness of control strategy. On the Grid-disconnected operation, micro grid inverter breaks away from the grid through the static switch, which can be equivalent to the traditional independent inverter. In this paper, we can take Multi Level Inverters (MLIs) as the micro sources, which supplies on the local load. Here we are listening about only Grid connected operation.

**KEYWORDS:** MATLAB/SIMULINK, Power electronics.

### I. INTRODUCTION

Distributed Generation (DG) is a closely watched the form of electricity generation in recent years. It is the main use of solar, wind, fuel cells and other renewable and clean energy generation, namely the protection of the environment, and also it saves energy and realizes the diversification of energy use. The current worldwide focus on large-scale use of power generation, long-distance transmission and large power supply grid interconnection, Distributed generation system (DGS) can help to improve power quality and power supply flexibility and expandability, maintain grid system stability, optimize the distribution system, which provides the spinning reserve and reduce the transmission and distribution cost which all are of great interest for power utilities. From the viewpoint of emission reduction compared to traditional power plants, DGS (Distributed generation system) is also attractive for societies.

The emergence of micro grid has also brought some new problems and challenges, such as the stability of power quality, relay protection setting and so on. Among them, how to effectively control micro grid inverter, which is one of the key issues to ensure that the system is stable and efficient operation, and also which is the main content of this paper. The case of grid connected of power system is the main concept of this paper this because he instability of voltage that can be controlled by the multi level inverter. The multi level inverter is compared with voltage source inverter the performance of multi level inverter is high and also harmonic values has been reduced. The total harmonic distortion value is decreased when using the multilevel inverter that is why the usage and popularity of multi level inverter is high compared with voltage source inverter.

Modeling and simulation are implemented using MATLAB/SIMULINK to verify the effectiveness of the proposed system.

# International Journal of Innovative Research in Science, Engineering and Technology

(An ISO 3297: 2007 Certified Organization)

Vol. 4, Special Issue 6, May 2015

## II. BLOCK DIAGRAM AND DESCRIPTION

Block diagram comprises of various blocks such as voltage controller, multi level inverter, three phase linear transformer, three phase harmonic filter and three phase circuit breaker. The voltage controller which is used as an input reference signal of voltage and frequency the output of the voltage controller block is connected to multi level inverter (MLI). The multi level inverter which is operated in dc supply the inverter is a device which convert dc supply into ac supply here the multi level inverter is used for stepped sine wave output then the output is connected to three phase linear transformer and it improves the sine wave output. The three phase linear transformer output is sine wave and it is added to PWM technique and produced the output.

The PWM output is connected to the harmonic filter block the harmonic filter which is used to filter the odd and even harmonics. Here we are using double tuned Harmonic filter and it is reduced the harmonics then output will be connected to

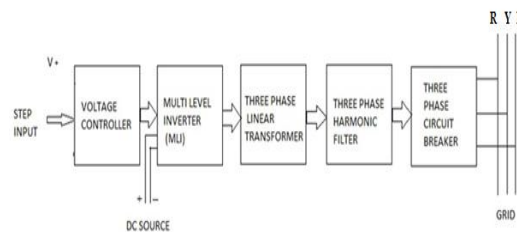

Fig.1. Block diagram of the proposed system

grid and the output of nominal voltage and frequency will be maintained constant and quality of power has been improved. Finally the power quality has been improved by using the multi level inverter.

## II. GRID CONNECTED OPERATION

When the inverter connects the grid, the grid can be regarded as an infinite capacity of ac voltage source. If the inverter adopts voltage control mode, it is easier to produce a large circulation, which is a strong impact for the inverter and the grid. The use of current control mode, only the need to control the inverter output current tracking the voltage of the grid, while setting the size of the output current, you can achieve the stability of the parallel operation, the control method is relatively simple and the results are better, so it has been widely used with the difference, the hysteresis comparator generates PWM signal for controlling power devices to adjust the grid connected current. This control scheme features: real-time control, the current of fast response and accurate control method is simple. The hysteresis current control chart is given below clearly shows that control strategy.

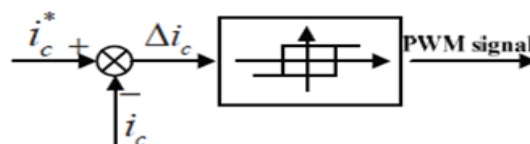

Fig.2 Hysteresis current control chart

Comparison of hysteresis current mode of the instantaneous way shown in Fig.2.  $\Delta i_c$  as the comparator hysteresis loop width, when the command current  $i_c^*$  and net current  $i_c$  rise the width than the difference, the hysteresis comparator generates PWM signal for controlling power devices to adjust the grid connected current. This control scheme features: real-time control, the current of fast response and accurate control method is simple. Take the grid current for reference:

## International Journal of Innovative Research in Science, Engineering and Technology

(An ISO 3297: 2007 Certified Organization)

Vol. 4, Special Issue 6, May 2015

$$L \frac{dI}{dt} = U_i - U_{grid} - IR_0$$

The formula:  $U_i$  is the output voltage of inverter,  $U_{grid}$  is grid voltage,  $I$  is the inductor current (that is the grid current),  $R_0$  is the equivalent resistance of the circuit. The plural form of domain is

$$I(s) = \frac{1}{Ls + R_0} (U_i(s) - U_{grid}(s)) = G_f(s) (U_i(s) - U_{grid}(s))$$

The closed loop grid current chart shown

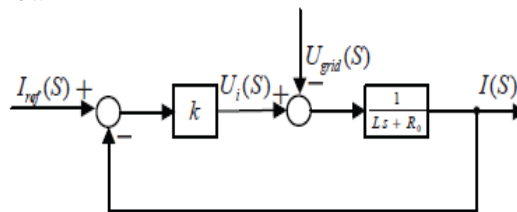

Fig.3 Closed loop grid current chart

The simulation results can be seen from the above, using hysteresis current loop control strategy, micro grid inverter output current is stable and low distortion. When the load changes, the current flows through the load also changes, and the voltage for the load always maintain a constant voltage.

Where  $I_{0a}$  is the cell's reverse saturation current at a solar radiation and reference temperature,  $V_g$  is the band-gap energy of the semiconductor used in the cell, and  $V_{oc}$  is the cells open circuit voltage. In this study, a general PV model is built and implemented using MATLAB/SIMULINK to verify the nonlinear output characteristics for the PV module. The proposed model is implemented, as shown in Fig. 4. In this model, whereas the inputs are the solar irradiation and cell temperature, the outputs are the photovoltaic voltage and current. The PV models parameters are usually extracted from the manufactures data sheet.

### IV. CIRCUIT DIAGRAM OF GRID CONNECTED MODE

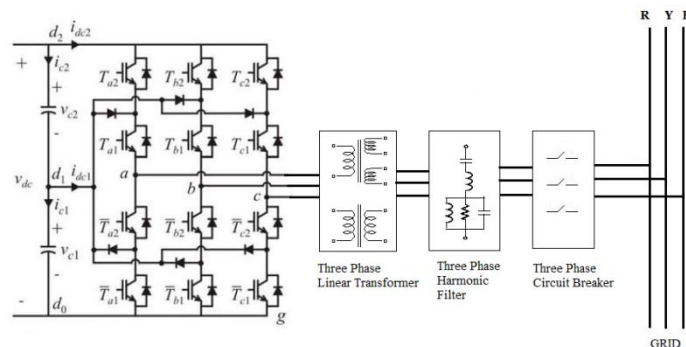

Fig.4 Circuit diagram of Diode Clamped Multi Level Inverter

Fig.4 shows a circuit diagram of proposed multi level inverter (MLI). The multi level inverter circuit which comprised of a IGBTs, diodes and capacitors here IGBT is used for switching purpose. The multi level inverter is most popularity when compared with other inverters like voltage source inverters (VSI). The multi level inverter is a recent

# International Journal of Innovative Research in Science, Engineering and Technology

(An ISO 3297: 2007 Certified Organization)

Vol. 4, Special Issue 6, May 2015

development for reducing the reactive power compensation when controlling the reactive power then we will get desired output. When increasing the level 2-level, 3-level etc. the losses will be reduced that is why we preferred for multi level inverter for an example use of 2-level inverter the losses is more but the use of 3-level inverter instead of 2-level the losses will be reduced up to 60% then the total losses will be reduced it is the main reason for moving on multi level inverter. Here we are using 3-level multi level inverter so far the losses will be reduced up to 60% and implemented by using 3-level pulse width modulation (PWM) technique.

## a) MULTI LEVEL INVERTER

The voltage source inverter produces an output voltage or a current with levels either 0 or  $\pm V_{dc}$ . They are known as two level inverter. To obtain quality voltage or a current waveform with a minimum amount of ripple content, they require high frequency switching along with various pulse width modulation (PWM) strategies. In high power and high-voltage applications, these two level inverters however, have some limitations in operating at high frequency mainly due to switching losses and constraints of device ratings. Moreover the semiconductor switching devices used in such a manner as to avoid problems associated with their series-parallel combinations that are necessary to obtain capability of handling high voltages and currents.

The multilevel inverters have drawn tremendous interest in the power industry. They present a new set of features that are well suited for use in reactive power compensation. It may be produce high power, high voltage inverter with the multilevel inverter structure because of the way in structure because of a way in such device voltage stresses are controlled in the structure. Increasing the number of voltage levels in the inverter without requiring higher ratings on individual device can increase in the power rating. The unique structure of multilevel source inverters allows them to reach high voltage with low harmonics without the use of transformers or series-connected synchronized switching devices. As the number of voltage level increases, the harmonic content of output voltage waveform decreases significantly.

## DESCRIPTION OF DIODE CLAMPED MULTI LEVEL INVERTER

A diode clamped Diode-clamped multilevel inverter (DCMLI) typically consist of  $(m-1)$  capacitors on the dc bus and produces  $m$  level on the base voltage. The numbering order of the switches is  $s_{a1}$ ,  $s_{a2}$ ,  $s_{a3}$ ,  $s_{a4}$ ,  $s_{a1}^1$ ,  $s_{a2}^1$ ,  $s_{a3}^1$ , and  $s_{a4}^1$ . The dc consists of four capacitors  $C_1, C_2, C_3$  and  $C_4$ . For a dc bus voltage  $V_{dc}$  the voltage across each capacitor is  $V_{dc}/4$  and the each device voltage stress is limited to one capacitor voltage level  $V_{dc}/4$  through clamping diodes. An  $m$ -level inverter leg requires  $(m-1)$  capacitors  $2(m-1)$  switches and  $(m-1)(m-2)$  clamping diodes. The diode-clamped inverter provides multiple voltage levels through connection of the phases to a series bank of capacitors. According to the original invention, the concept can be extended to any number of levels by increasing the number of capacitors. Early descriptions of this topology were limited to three-levels where two capacitors are connected across the dc bus resulting in one additional level. The additional level was the neutral point of the dc bus, so the terminology neutral point clamped (NPC) inverter was introduced.

However, with an even number of voltage levels, the neutral point is not accessible, and the term multiple point clamped (MPC) is sometimes applied. Due to capacitor voltage balancing issues, the diode-clamped inverter implementation has been mostly limited to the three level. Because of industrial developments over the past several years, the three level inverter is now used extensively in industry applications. Although most applications are medium-voltage, a three-level inverter for 480V is on the market but here we are using the voltage range 400V. Figure shows the topology of the three-level diode-clamped inverter. Although the structure is more complicated than the two-level inverter, the operation is straightforward and well known. In summary, each phase node ( $a$ ,  $b$ , or  $c$ ) can be connected to any node in the capacitor bank ( $d_0$ ,  $d_1$ , or  $d_2$ ). Connection of the  $a$ -phase to junctions  $d_0$  and  $d_2$  can be accomplished by switching transistors  $T_{a1}$  and  $T_{a2}$  both off or both on respectively. These states are the same as the two-level inverter yielding a line-to-ground voltage of zero or the dc voltage.

These equations allow system simulation including capacitor voltage variation. For more simulation detail, the transistor and diode KVL and KCL equations may be implemented. This allows inclusion of the device voltage drops (as well as conduction losses) and the individual device voltages and currents. To express this relationship, consider the general  $n$ -level  $a$ -phase diode-clamped structure shown in Figure 4 There in only the upper half of the inverter is

# International Journal of Innovative Research in Science, Engineering and Technology

(An ISO 3297: 2007 Certified Organization)

Vol. 4, Special Issue 6, May 2015

considered since the lower half contains complementary transistors and may be analyzed in a similar way. Through the clamping action of the diodes, the blocking voltage of each transistor is the Corresponding capacitor voltage in the series bank. By calculation of the diode voltages, it can be seen that the inner diodes block a higher voltage. For example, in the four-level topology the inner diodes must block two-thirds of the dc voltage while the outer diodes block one-third. This is a well known disadvantage of the diode-clamped topology. For this reason, some authors represent the higher voltage diodes with lower voltage diodes in series or alter the structure of topology the same voltage.

## V. CONTROL CIRCUIT SWITCHING

While designing this circuit, a choice had to be made between the two main types of switches used in power electronics. One is the power MOSFET, which is much like a standard MOSFET, but designed to handle relatively large voltages and currents. The other is the insulated gate bipolar transistor, or IGBT. Each has its advantages, and there is a high degree of overlap in the specifications of the two. IGBTs tend to be used in very high voltage applications, nearly always above 200V, and generally above 600V. They do not have the high frequency switching capability of MOSFETs, and tend to be used at frequencies lower than 29 kHz. They can handle high currents, are able to output greater than 5kW, and have very good thermal operating ability, being able to operate properly above 100 Celsius. One of the major disadvantages of IGBTs is their unavoidable current tail when they turn off. Essentially, when the IGBT turns off, the current of the gate transistor cannot dissipate immediately, which causes a loss of power each time this occurs. This tail is due to the very design of the IGBT and cannot be remedied.

IGBTs also have no body diode, which can be good or bad depending on the application. IGBTs tend to be used in high power applications, such as uninterruptible power supplies of power higher than 5kW, welding, or low power lighting. Power MOSFETS have a much higher switching frequency capability than do IGBTs, and can be switched at frequencies higher than 200 kHz. They do not have as much capability for high voltage and high current applications, and tend to be used at voltages lower than 250V and less than 500W. MOSFETs do not have current tail power losses, which makes them more efficient than IGBTs. Both MOSFETs and IGBTs have power losses due to the ramp up and ramp down of the voltage when turning on and off (dV/dt losses). Unlike IGBTs, MOSFETs have body diode. Generally, IGBTs are the sure bet for high voltage, low frequency (>1000V, <20 kHz) uses and MOSFETs are ideal for low voltage, high frequency applications (<250V, >200 kHz). In between these two extremes is a large grey area. In this area, other considerations such as power, percent duty cycle, Availability and cost tend to be the deciding factors. Our application in this project is 250W, with a 170VDC bus (ideally), and a switching frequency around 20kHz. These specifications make power MOSFETs the ideal choice for us. If our system was a larger, commercial application with a high power output, IGBTs would be the choice..

## VI. MATLAB INTRODUCTION

MATLAB is a high-level language and interactive environment for numerical computation, visualization, and programming. Using MATLAB, you can analyze data, develop algorithms, and create models and applications. The language, tools, and built-in math functions enable you to explore multiple approaches and reach a solution faster than with spreadsheets or traditional programming languages, such as C/C++ or Java. MATLAB is a program that was originally designed to simplify the implementation of numerical linear algebra routines. It has since grown into something much bigger, and it is used to implement numerical algorithms for a wide range of applications. The goal of the tutorials here is to provide a simple overview and introduction to mat lab. The tutorials are broken up into some of the basic topics. The first includes a few examples of how Mat lab makes it easy to create and manipulate vectors. The tutorials move from the simple examples and lead to more complicated examples.

# International Journal of Innovative Research in Science, Engineering and Technology

(An ISO 3297: 2007 Certified Organization)

Vol. 4, Special Issue 6, May 2015

## SIMULATION DIAGRAM OF GRID CONNECTED MULTI LEVEL INVERTER

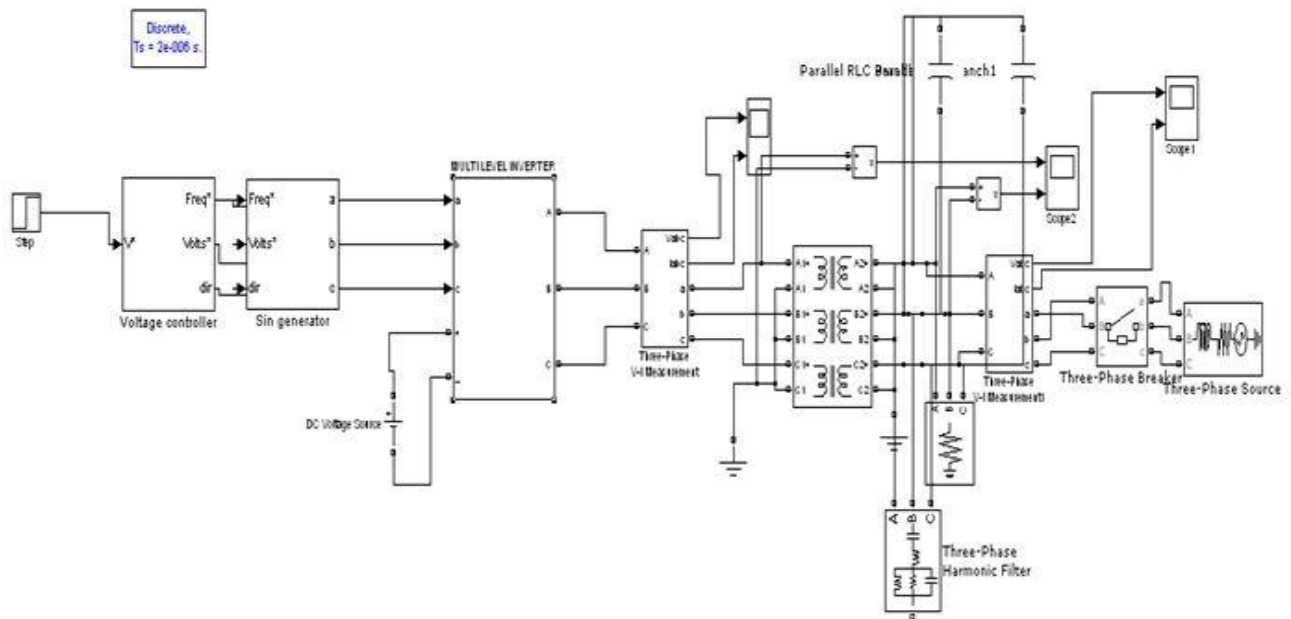

Fig.5 PWM comparison with reference signal

### PULSE WIDTH MODULATION

The most common and popular technique of digital pure-sine wave generation is pulse-width-modulation (PWM). The PWM technique involves generation of a digital waveform, for which the duty-cycle is modulated such that the average voltage of the waveform corresponds to a pure sine wave. The simplest way of producing the PWM signal is through comparison of a low-power reference sine wave with a triangle wave.

Using these two signals as input to a comparator, the output will be a PWM signal. This PWM signal can then be used to control switches connected to a high-voltage bus, which will replicate this signal at the appropriate voltage. Put through an LC filter, this PWM signal will clean up into a close approximation of a sine wave. Though this technique produces a much cleaner source of AC power than either the square or modified sine waves, the frequency analysis shows that the primary harmonic is still truncated, and there is a relatively high amount of higher level harmonics in the signal.

### OUTPUT OF MULTILEVEL INVERTER COMBINING WITH PWM

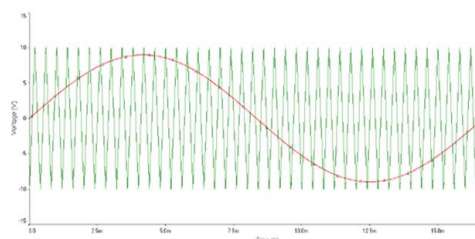

Fig.6 PWM comparison with reference signal

# International Journal of Innovative Research in Science, Engineering and Technology

(An ISO 3297: 2007 Certified Organization)

Vol. 4, Special Issue 6, May 2015

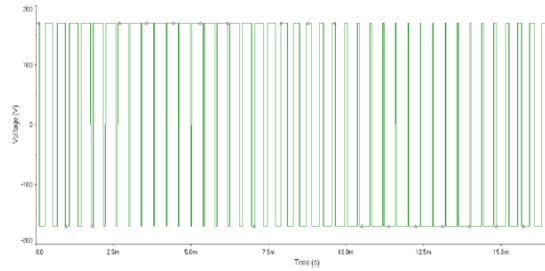

Fig.7 PWM output (unfiltered)

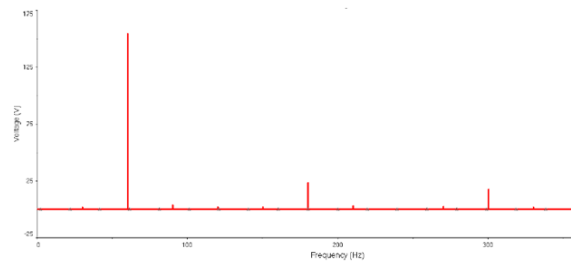

Fig.8 Harmonic analysis

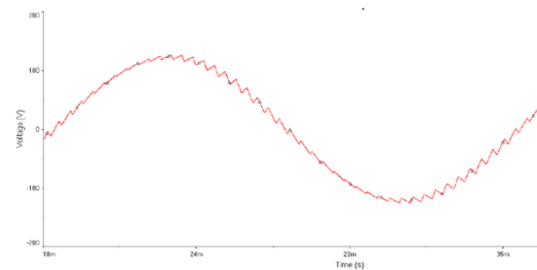

Fig.9 PWM output (Filtered)

## DIFFERENT TYPES OF FILTER'S OUTPUT

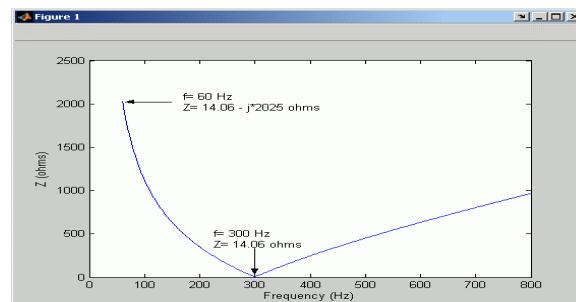

Fig.10 C-type filter output

# International Journal of Innovative Research in Science, Engineering and Technology

(An ISO 3297: 2007 Certified Organization)

Vol. 4, Special Issue 6, May 2015

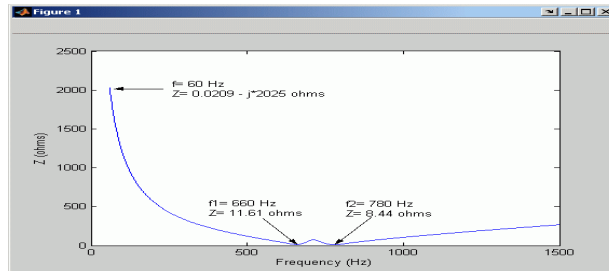

Fig.11 Single tuned filter output

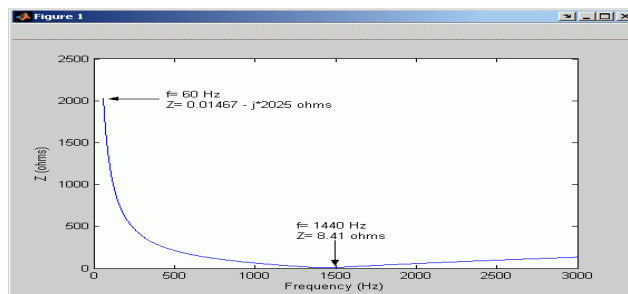

Fig.12 Double tuned filter output

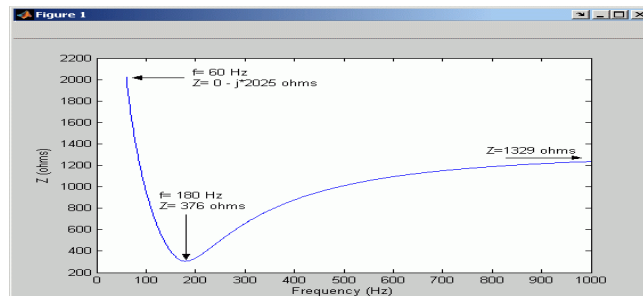

Fig.13 High Pass filter output

## VII. SIMULATION OUTPUT WAVEFORMS

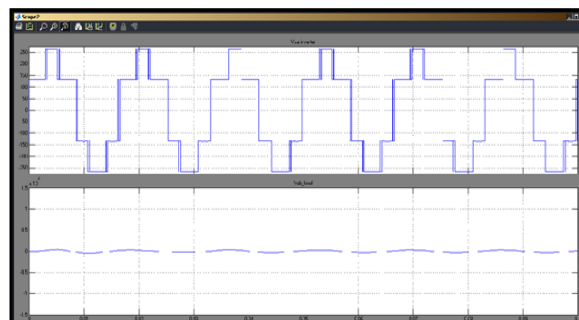

Fig.14 Three phase stepped output waveform



## International Journal of Innovative Research in Science, Engineering and Technology

(An ISO 3297: 2007 Certified Organization)

Vol. 4, Special Issue 6, May 2015

### OUTPUT WAVEFORM OF 3 $\phi$ GRID CONNECTED SYSTEM

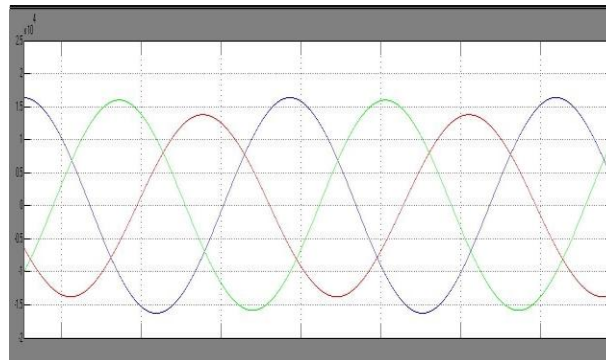

Fig.15 Three phase output voltage

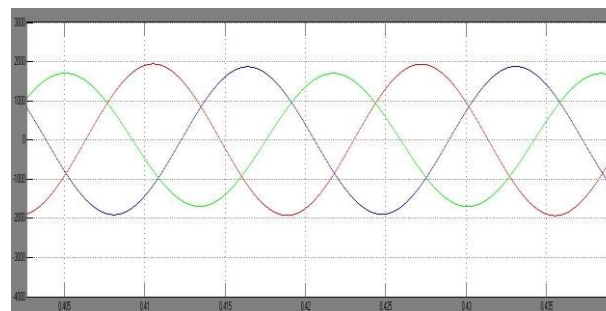

Fig.16 Three phase output current

### VIII. CONCLUSION

This paper is explained based on the traditional independent inverter for Grid-connected inverter control strategy, combining the distributed power and micro grid inverter characteristics, a suitable for micro grid inverter control strategy is put forward. Switching of Grid-connected mode for micro grid inverter has been studied. On the Grid-disconnected operation micro grid inverter supplies the important loads that ensures load voltage and frequency stability. Micro grid inverter can smoothly switch Grid-connected operation, and switching operation of the system has good performance. The system controller design is simple, practical and efficient, easy to implement. The simulation results are shown that the proposed control method is feasible and effective.

### REFERENCES

- [1] Lasseter R H, Piagi P. Microgrid: a conceptual solution[C]. Proc. of the 35th PESC, Aachen, Germany,2004: 4285-4290.
- [2] Georgakisl D, Papathanassiou S. Operation of a prototype microgrid system based on micro-sources equipped with fast-acting power electronics interfaces[C]. IEEE Conf., Aachen, Germany, 2004: 2521-2526.
- [3] C.Nagarajan and M.Madheswaran - 'Performance Analysis of LCL-T Resonant Converter with Fuzzy/PID Using State Space Analysis"- Springer, Electrical Engineering, Vol.93, March 2011.
- [4] C.Nagarajan and M.Madheswaran, Stability Analysis of Series Parallel Resonant Converter with Fuzzy Logic Controller Using State Space Techniques", Taylor & Francis, Electric Power Components and Systems, Vol.39 (8), pp.780-793, 2011.
- [5] C.Nagarajan and M.Madheswaran - 'Experimental verification and stability state space analysis of CLL-T Series Parallel Resonant Converter' - Journal of ELECTRICAL ENGINEERING, Vol.63 (6), pp.365-372, Dec.2012.
- [6] C.Nagarajan and M.Madheswaran - 'Analysis and Implementation of LLC-T Series Parallel Resonant Converter with Fuzzy controller'- International Journal of Engineering Science and Technology (IJEST), Applied Power Electronics and Intelligent Motion Control. Vol.2 (10), pp 35-43, December 2010
- [7] C.Nagarajan and M.Madheswaran - 'Performance Estimation of LCL-T Resonant Converter with Fuzzy / PID Controller'- International Journal of Computer and Electronic Engineering (IJCEE), Vol.2 (3), pp.534-542, June 2010

## International Journal of Innovative Research in Science, Engineering and Technology

*(An ISO 3297: 2007 Certified Organization)*

**Vol. 4, Special Issue 6, May 2015**

- [8] C. Nagarajan, M.Madheswaran and D.Ramasubramanian- 'Development of DSP based Robust Control Method for General Resonant Converter Topologies using Transfer Function Model'- Acta Electrotechnica et Informatica Journal , Vol.13 (2), pp.18-31, April-June.2013
- [9] C.Nagarajan and M.Madheswaran - 'DSP Based Fuzzy Controller for Series Parallel Resonant converter'- Springer, Frontiers of Electrical and Electronic Engineering, Vol. 7(4), pp. 438-446, Dec.12.
- [10] C.Nagarajan and M.Madheswaran - 'Experimental Study and steady state stability analysis of CLL-T Series Parallel Resonant Converter with Fuzzy controller using State Space Analysis'- Iranian Journal of Electrical & Electronic Engineering, Vol.8 (3), pp.259-267, September 2012.
- [11] Nikkhajoei H, Lasseter R H. Microgrid Protection[J] .IEEE Power Engineering Society General Meeting. 2007 .
- [12] H. Nikkhajoei and R. Lasseter, Microgrid Protection, Proceedings of the 2007 IEEE Power Engineering Society General Meeting, Tampa,USA,June 24-28, 2007.
- [13] M. Brucoli and T. Green, Fault Behaviour in Islanded Microgrids, Proceedings of the 19th International Conference on Electricity Distribution (CIRED), Vienna, Austria, May 2007.
- [14] H. Al-Nasseri, M. Redfern and F. Li, A Voltage Based Protection for Micro-Grids Containing Power Electronic Converters, Proceedings of the 2007 IEEE Power Engineering Society General Meeting, June 18-22,2006.
- [15] Xiao-bo Fan,Dai-run Zhan,Qian Sun, "Hysteresis Current Control Strategy for Three-phase Three-wire Active Power Filter," Automation of Electric Power Systems, 2007,pp.57-60.
- [16] H. Al-Nasseri and M. Redfern, A New Voltage Based Relay Scheme to Protect Micro-Grids Dominated by Embedded Generation Using Solid State Converters, Proceedings of the 19th International Conference on Electricity Distribution (CIRED), Vienna, Austria, May 2007.
- [17] T. Wijnhoven, Beveiliging van microgrids met invertorgekoppelde bronnen,M.Sc. dissertation, K.U. Leuven, June 2008.
- [18] B. Hadzi-Kostova, Z. Styczynski and R. Krebs, New Protection Concepts for Distribution Systems with Dispersed Generation, Proceedings of the IEEE Power Tech Conference, St. Petersburg,Russia, June 27-30, 2005.