

# Fractal Antenna Design for RFID Tag

K.Vasanthi

Assistant Professor, Department of Electronics and Telecommunication Engineering, Karpagam College of Engineering, Coimbatore, Tamil Nadu, India

**ABSTRACT:** One of the prevailing trends in modern wireless devices is continuing decrease in physical size of the antenna. So the design challenge is getting the small size antenna that has a good efficiency and radiation. The use of fractal patterns in antenna design provides the simple and efficient method for obtaining the desired compactness and multiband operation. This Paper presents the design of multiband RFID Tag Antenna. Several properties of the proposed antenna for multiband operation will be investigated which include the return loss, radiation pattern and gain by using the Software HFSS (High Frequency Structural Simulator).

**KEYWORDS:** RFID technology, RFID tag antenna, Fractal antenna, Patch antenna, Antenna Design.

## I. INTRODUCTION

Radio Frequency Identification (RFID) is an automatic wireless data collection technology. The RFID system consists of RFID Reader and RFID tag where RFID reader transmits a modulated RF signal to the RFID tag which consists of an antenna and an integrated circuit chip. The chip receives power from the antenna and responds by varying its input impedance and thus modulating the backscattered signal with data. Important RFID tag characteristics are maximum range and orientation sensitivity. In order to achieve optimum operating condition, the antenna impedance should be matched correctly to the chip impedance that is known to change as well as with frequency. When both chip impedance and antenna impedance is complex, calculating an accurate power reflection coefficient for tag antenna design is a challenging process.

RFID involves contactless reading and writing of data into an RFID tag's nonvolatile memory through an RF signal. The reader emits an RF signal and data is exchanged when the tag comes in proximity to the reader signal. Tags can be categorized as follows:

1. Active tag, which has a battery that supplies power to all functions;
2. Semi passive tag, which has a battery used only to power the tag IC, and not for communication;
3. Passive tag, which has no battery on it. The absence of power supply makes passive tags much cheaper and more reliable than active tags.

Passive and semi passive RFID tags do not use a radio transmitter; instead they use modulation of the reflected power from the tag antenna. RFID principles and its applications are explained in [4]. In paper [2] the loader meander antenna for box tracking in warehouses are designed and experimentally tested.

## II. LITERATURE SURVEY

In paper [6], the reason for using the L-band frequency in health caring device was explained. The non-contact vital sign system was tested using the several antennas like Helical, Yagi, Log Periodic and Patch. Among the all, the patch antenna has the least error values. In the paper [1], the authors were proposed a modified loop antenna by applying Minkowski fractal concept, which is designed for reduction of antenna size. The [2] paper presents the overview of antenna design for passive radio frequency identification (RFID) tag for box tracking in warehouses that is A loaded meander antenna design was described. The paper [5] presents a Planar antenna with Microstrip feed sierinski

# International Journal of Innovative Research in Science, Engineering and Technology

(An ISO 3297: 2007 Certified Organization)

Vol. 4, Issue 10, October 2015

carpet fractal geometry for multiband applications. In paper [3], the rectangular patch was designed for the resonant frequency of 5.2GHz. In this paper the S-Parameter values were decreased after each iteration.

## III. FRACTAL ANTENNA

In the study of antennas, fractal antenna theory is a relatively new area. However, fractal antennas and their superset, fractal electrodynamics, are a hotbed of research activity these days. The term fractal means linguistically broken or fractured and is from the Latin fractus. Fractals are geometrical shapes, which are self-similar, repeating themselves at different scales. Many mathematical structures are fractals, for example, Sierpinski's gasket, Cantor's comb, von Koch's snowflake, the Mandelbrot set, and the Lorenz attractor. The Papers [3], [5], [6] are explained about the sierpinski carpet type fractal antennas. But in these papers the return loss values are decreased after each iteration. [1]st paper in reference is Minkowski's fractal model.

Fractal antennas do not have any characteristic size; fractal structures with a self-similar geometric shape consisting of multiple copies of themselves on many different scales have the potential to be frequency-independent or at least multi frequency antennas. Fractal technology is geometry-based, not material based. Therefore, fractal antennas are manufactured from standard materials and substrates, using standard processes. Fractals are patterns that feature geometric elements at ever smaller scales to produce both self-similar and irregular shapes and surfaces. Fractal shapes are often self-similar (segments look like each other and like the whole object) and independent of scale (they look similar). These fractal antenna concepts are explained in [7].

## IV - SOFTWARE DESIGN AND SIMULATION RESULTS

The Ansoft HFSS 13 is used for designing the antenna. HFSS stands for High Frequency Structure Simulator. The initial task in creating an HFSS model consists of the creation of the physical model. In this, I am designing a rectangular patch antenna for the frequency of 2GHz. The material, taken for substrate, was FR4. The dielectric constant for FR4 is 4.4. The substrate height is 1.6mm.

### Design Specifications

- Calculation of width

$$W = \frac{c}{2f_0} \sqrt{\frac{2}{\epsilon_r + 1}}$$

Where

c = free space velocity of light

$\epsilon_r$  = Dielectric constant of substrate

- Effective dielectric constant of micro strip patch antenna

$$\epsilon_{reff} = \frac{\epsilon_r + 1}{2} + \frac{\epsilon_r - 1}{2} (1 + 12h/W)^{1/2}$$

- Actual length of the patch

$$L = L_{eff} - \Delta L$$

# International Journal of Innovative Research in Science, Engineering and Technology

(An ISO 3297: 2007 Certified Organization)

Vol. 4, Issue 10, October 2015

Where 
$$L_{eff} = \frac{c}{2f_0 \sqrt{\epsilon_{reff}}}$$

- Calculation of Length Extension

$$\frac{\Delta L}{h} = 0.412 \frac{(\epsilon_{reff} + 0.3)(W/h) + 0.264}{(\epsilon_{reff} - 0.258)(W/h) + 0.8}$$

According to these design specifications, the length and width of rectangular patch antenna is calculated and the rectangular patch is designed using HFSS. It is shown in figure 1.

TABLE I  
ANTENNA PARAMETERS

Symbol	Description	Calculated values
$f_0$	Solution frequency	2GHz
$\epsilon_r$	Substrate dielectric constant	4.4
h	Substrate height	1.6mm
W	Patch width	45.6435mm
L	Patch length	35.4420mm
$\epsilon_{reff}$	Effective dielectric constant	4.1260
$l_{eff}$	Effective length	36.9226mm

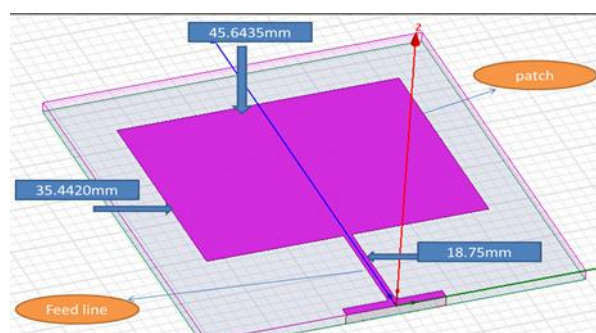

Figure 1. Rectangular Patch Antenna Geometry

The figure 1 shows the rectangular patch antenna geometry model which was designed using the antenna design software HFSS. The iterations are then applied on the base model to produce the fractal patterns. The iteration models are given in the following figures.

# International Journal of Innovative Research in Science, Engineering and Technology

(An ISO 3297: 2007 Certified Organization)

Vol. 4, Issue 10, October 2015

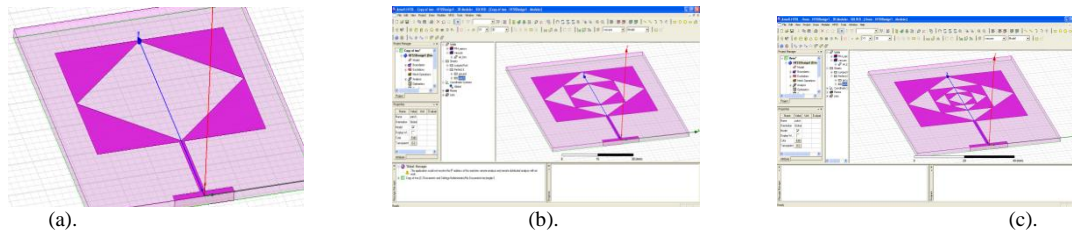

Figure 2. (a) First Iteration Model (b) Second Iteration Model (c) Third Iteration Model

Figure 2 represents the three iteration model that was produced by applying fractal concept on the rectangular patch which is in figure1. After the each iteration, the model would be simulated. Then return loss values are plotted using the HFSS Results menu. The comparative chart of return loss for all iteration is shown below in figure 3. The plot consists the return loss plot of rectangular patch, first iteration model, second iteration model and third iteration model. They are differentiated by using various colors. Return loss value of each model and its corresponding color is displayed in Table II.

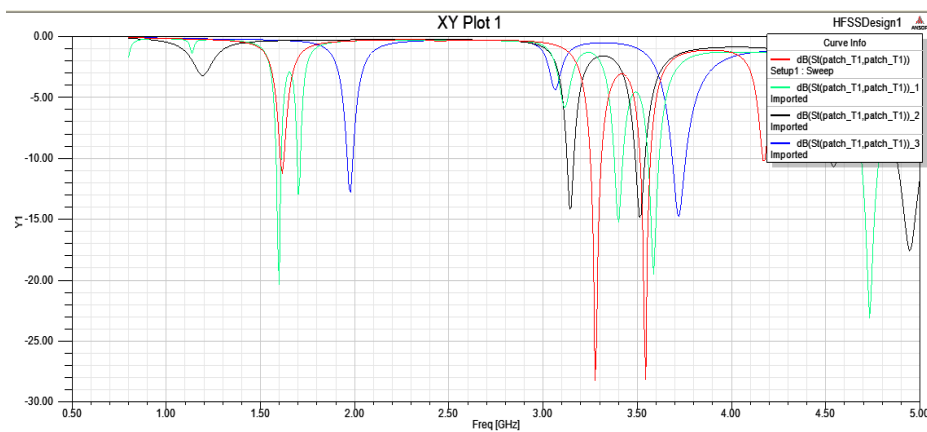

Figure 3. Simulated Return Loss Plot of rectangular patch and three iteration models.

TABLE II RETURNLOSS COMPARISION TABLE

S.NO	ITERATION	RETURN LOSS(dB)
1	Base model	-12.79 at 1.9GHz
2	First Iteration	-14.17 at 3.13GHz
3	Second Iteration	-20.38 at 1.69GHz
4	Third Iteration	-11.27 at 1.61GHz

# International Journal of Innovative Research in Science, Engineering and Technology

(An ISO 3297: 2007 Certified Organization)

Vol. 4, Issue 10, October 2015

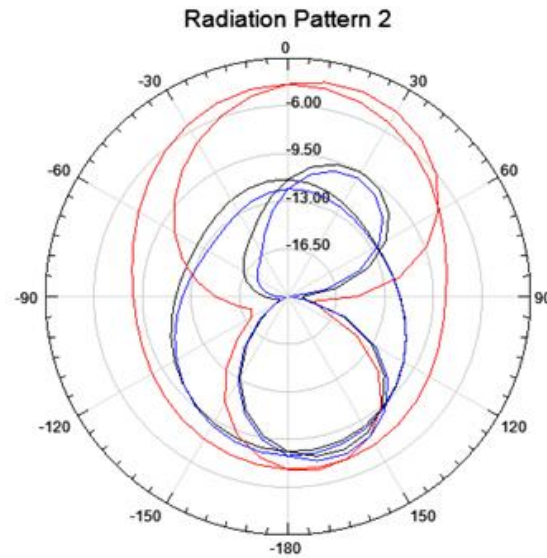
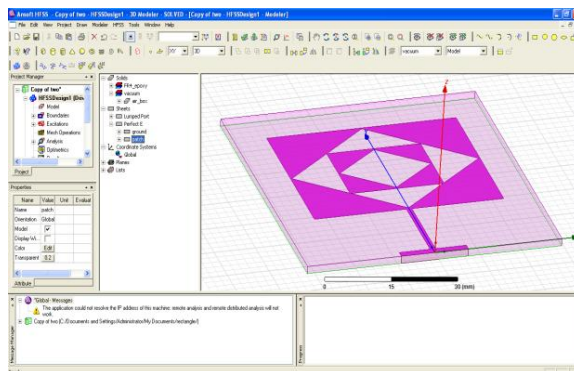

Figure 4. Radiation Pattern of all three Iteration Models

- First iteration
- Second iteration
- Third iteration

Table II presents the return loss values for all the iteration. In this, the second iteration model produces the best result in return loss. It provides -20.38 dB return loss at 1.69GHz frequency. The third iteration produces less return loss value than the second iteration at our desirable frequency. But it can produce better return loss value at high frequency. And the radiation pattern for all the models also presented in the Figure 4. In this also, the second iteration produces the Omni directional pattern in H-plane and bidirectional in E-plane. So the second Iteration Model will be chosen for the fabrication process.



(a)

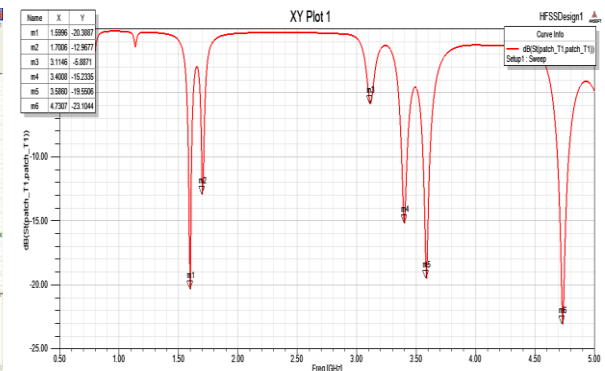

(b)

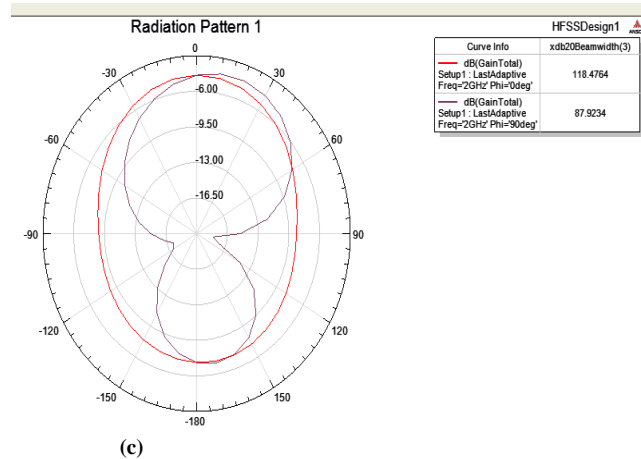

Figure 5. (a) Second Iteration Model (b) Return Loss Plot and (c) Radiation Pattern of Second Iteration Model

## V. CONCLUSION AND FUTURE WORK

The design of multiband RFID tag antenna was proposed in this paper. The proposed antenna offers good performance at 1.69 and 4.7 GHz that can be worked on L and S band applications. After the fabrication, the antenna combined with Application Specific Integrated Chip will be designed as a RFID tag. The ASIC can be chosen according to the requirement. With the reader that matched with the tag performance, this system can be implemented as a RFID device.

## REFERENCES

- [1] Abubeker A. Yussuf, Md Rafiqul Islam, A.H.M.Zahirul Alam, "Design of Multi – Band RFID Passive Tag Antenna", ICCCE 2010 11-13 May 2010.
- [2] K.V. Seshagiri Rao, Pavel V. Nikitin, Sander F. Lam, "Antenna Design For UHF RFID Tags", IEEE Transaction on Antenna and Propagation Vol 53, No 12, December 2005.
- [3] S B Kumar, Dr. P K Singha, ON THE INVESTIGATION OF A SIERPINSKI'S CARPET MICROSTRIP FRACTAL ANTENNA, IJESAT Vol. 2, Issue. 2, 202-203.
- [4] Stephen A. Weis MIT CSAIL RFID (Radio Frequency Identification): Principles and Applications
- [5] T. Shanmuganatham, R. Mohanmurali, Sierpinski Carpet Fractal Antenna for Multiband Applications, International Journal of Computer Applications Vol. 39, No. 14, 2012.
- [6] Vighneshrudra Das, Alex Boothby, \*Royce Hwang, Tam Nguyen, "Antenna Evaluation of a Non-Contact Vital Signs Sensor for Continuous Heart and Respiration Rate Monitoring" IEEE 13 BioWireless 2012.
- [7] W.L. Chen and G.M. Wang, Small Size Edge-Fed Sierpinski Carpet Microstrip Patch Antennas, Progress In Electromagnetic ResearchC, Vol. 3, 195-202, 2008.
- [8] Werner Hodlmayr, FRACTAL ANTENNAS – Introduction to fractal technology and presentation of a fractal antenna adaptable to any transmitting frequency – The "FRACTENT"