

International Journal of Innovative Research in Science, Engineering and Technology

(An ISO 3297: 2007 Certified Organization)

Vol. 4, Special Issue 13, December 2015

In Three Level DC - DC Converters Protection Schemes for Various Fault Conditions

S.Sathyamoorthi¹, S.Sriram²

Assistant Professor, Dept. of Electrical & Electronics Engineering, Sasurie College of Engineering, Tiruppur,
Tamilnadu, India^{1&2}

ABSTRACT: Fault detection and protection is an important design aspect for any power converter, especially in high-power high-voltage applications, where cost of failure can be high. The three-level dc-dc converter and its varied derivatives are attractive topologies in high-voltage high-power converter applications. The protection method can not only prevent the system failure against unbalanced voltage stresses on the switches, but also provide a remedy for the system as faults occur and save the remaining components. The three-level converter is subject to voltage unbalance in certain abnormal conditions, which can result in switch overvoltage and system failure. The reasons for the unbalanced voltage stresses are fully investigated and categorized. The solutions to each abnormal condition are introduced. In addition to the voltage unbalance, the three-level converters can be protected against multiple faults by the proposed protection method through monitoring the flying capacitor voltage. The protection circuit is simple and can be easily implemented, while it can effectively protect the three-level converters and its derivatives, which has been verified by the experiment with a three-level parallel resonant converter

KEYWORDS: Flying capacitor, protection, three-level dc-dc converter, voltage unbalance.

I. INTRODUCTION

Faults can occur even in carefully designed circuits. Fault detection and protection is an important design aspect for power converters, especially in high-power high-voltage applications, where cost of failure can be high and the consequence of failure can be serious. For dc-dc high-voltage high-power converter applications, the three-level dc-dc converter and its varied derivatives are attractive topology choices. The main advantage of three-level dc-dc converters is that the main switches only withstand half of the input dc-link voltage, so lower voltage rating devices with better performance can be used. On the other hand, three-level converters need to have balanced dc voltages V_{cin1} and V_{cin2} and two clamping diodes to ensure proper operation and equal voltage sharing. The flying capacitor is initially introduced by Fransisco for the phase shift operation. The flying capacitor can help to decouple the switching transition of the outer two switches (S1 and S4) and the inner two switches (S2 and S3). When one of the outer switches turns OFF, its parallel capacitor is charged, and meanwhile the parallel capacitor of the other outer switches discharged through the flying capacitor so that zero voltage switching (ZVS) can be achieved. The two capacitors in parallel with the inner two switches do not participate in this switching transition and vice versa. Furthermore, with phase shift pulse width modulation (PWM) control, the flying capacitor is essentially connected in parallel to the input capacitors during the freewheeling stage of the converter alternatively. Therefore, the flying capacitor can alleviate the voltage imbalance of the input capacitors with phase shift PWM operation. In addition, the flying capacitor also works as a snubber capacitor for the two inner switches. Under normal operating conditions, V_{css} should have a nominal voltage equal to $V_{in}/2$. An abnormal V_{css} may indicate an abnormal circuit condition or fault, which can be used as the basis for fault detections.

International Journal of Innovative Research in Science, Engineering and Technology

(An ISO 3297: 2007 Certified Organization)

Vol. 4, Special Issue 13, December 2015

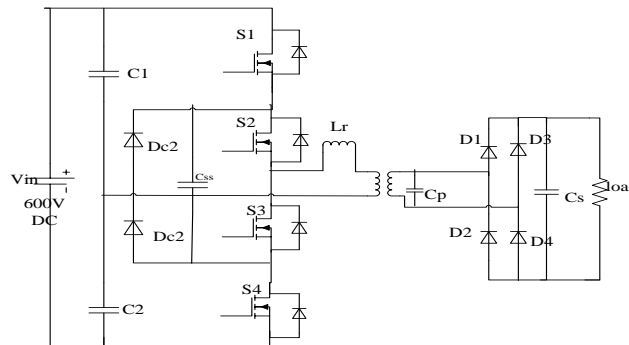

Fig.1 Three Level Parallel Resonant Converter

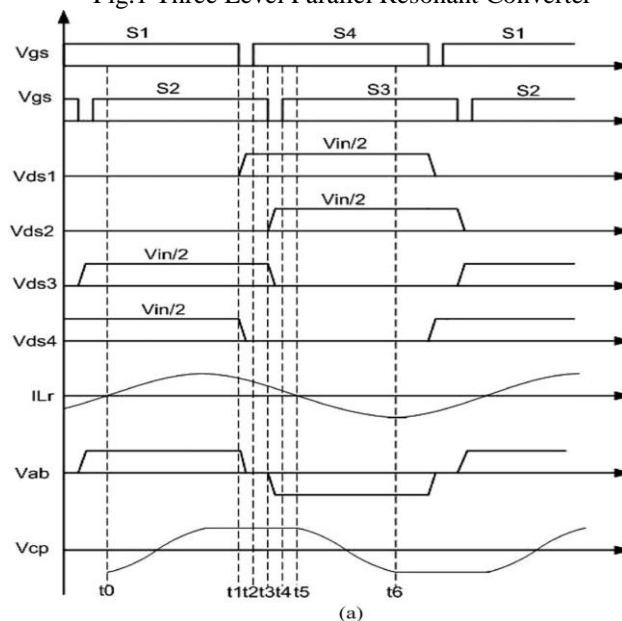

Fig.2. PWM Operation mode

First, with the traditional operation schemes, the reasons that cause the abnormal voltage stresses are thoroughly analyzed and categorized, as well as the solutions according to the different reasons. In essence, these issues can be fixed or avoided in a normal converter design and operation, as is stopped by protection circuit. Then the possible faults of the three-level parallel resonant converter (PRC) are systemically analyzed and summarized with the help of simulation in section III. In Section IV, a protection circuit with fast response time is presented, along with the flying capacitor design and the circuit design criteria. Finally, Section V provides experimental results to verify the analysis and the protection functions.

II OPERATION PRINCIPLE AND SOLUTIONS TO UNBALANCED VOLTAGE STRESSES

The typical waveforms for three-level parallel resonant converter with phase-shift (PS) and PWM operation modes. Since both operation modes have to guarantee that the outer switch (S1 or S4) should be turned OFF no later than the inner switch (S2 or S3) in the same leg for ZVS achievement. The problem of voltage unbalance across the switches in the same leg at two specific conditions, with open voltage loop control and at light load.

International Journal of Innovative Research in Science, Engineering and Technology

(An ISO 3297: 2007 Certified Organization)

Vol. 4, Special Issue 13, December 2015

However, V_{css} could also be changed under other various conditions, such as zero-current-switching(ZCS)/non-zero-voltage switching(ZVS)operation, high voltage ripple on input capacitors, unbalanced switching timing, etc. In essence, these can be fixed when the problem is stopped by protection and located. The solutions to the issues are introduced. A thorough analysis on abnormal conditions is necessary for designers to understand the converter operation and know the limits so that a protection can be designed to tolerate to normal operation without losing sensitivity. These abnormal conditions can be classified into three main categories, as enumerated in the following.

A. Abnormal Input Capacitor Voltages Due to Input Voltage

The voltage across the two input capacitors (C_{in1} and C_{in2}) are needed to split the input voltage equivalently, and the neutral point, has half of the input voltage ($V_{in}/2$). So the neutral point voltage and V_{css} are fundamentally determined by the input voltage. If the input voltage varies beyond the allowed range, obviously, the over/under input voltage lockout can be triggered by monitoring the V_{css} .

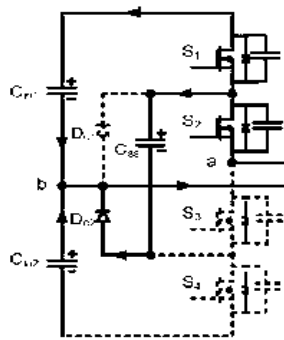

Fig.3. Charging loop when the voltage of C_{in1} is higher than half of the input voltage

B. Abnormal Input Capacitor Voltages Due to Unbalanced

Another main abnormal performance of input capacitor voltages is unbalanced voltage. When the voltage across C_{in1} is higher than $V_{in}/2$, the flying capacitor will be charged through down clamping diode D_{c2} . If the C_{in2} voltage is higher than $V_{in}/2$, the flying capacitor will be charged through clamping diode D_{c1} . More explicitly, the flying capacitor will be paralleled with the input capacitor which has high voltage stress. It should be noted that this is also why the flying capacitor helps to alleviate the voltage unbalance of the input capacitors. No matter which input capacitor has higher voltage, or, in other words, no matter the neutral point has higher or lower voltage than $V_{in}/2$, the flying capacitor voltage will be charged to the peak voltage of the input capacitor with a higher voltage. So unequal capacitances of input capacitors, unbalanced duty cycles or mismatched switching timings, etc., belong to this case, which contributes the unbalanced input capacitor voltages and then the abnormal flying capacitor voltage. When the problem is caused by these issues, it can be easily solved in circuit. Normally these tiny unbalanced capacitances and duty cycles can be tolerated without serious consequence. In addition, the unbalanced duty cycles can be alleviated by the flying capacitor in the phase-shift operation. A control circuit to balance the unsymmetrical duty cycles by monitoring voltage across the flying capacitor for the nonphaseleg structure converter, such as buck, boost. It also can be adjusted for the circuit with the phase leg structure when the unbalanced duty cycle is an issue. Moreover, even if the voltages across the input capacitors are balanced, the V_{css} still can be influenced by the voltage ripple on the input capacitor. converter, loss will be high due to the input diode bridge.

C. Losing Discharging Path Even With Normal Input capacitor voltage

Even if the neutral point voltage is normal, the unbalanced voltage stresses still can happen in some conditions. In a normal operation, the flying capacitor can be charged through the upper clamping diode (D_{c1}) or $S1$. Or it can be charged through bottom clamping diode (D_{c2}) and $S4$ due to the symmetrical structure. The only possible discharging path for flying capacitor is through $S2$ or $S3$. If the flying capacitor can be charged through $S2$ or $S3$ instead of discharging in some conditions, the flying capacitor voltage will definitely increase because it has no way to decrease.

International Journal of Innovative Research in Science, Engineering and Technology

(An ISO 3297: 2007 Certified Organization)

Vol. 4, Special Issue 13, December 2015

With the conventional ZVS control (S1 is turned OFF before S2, and S4 is turned OFF before S3), the commutation of the phase shift provides a discharge loop for flying capacitor when ZVS operation is desired. However, when the converter loses ZVS, such as at light load; or the switching timing is wrong, such as when S2 is switched OFF before S1 or S3 is switched OFF before S4 the flying capacitor will be charged instead of being discharged. The $V_{c_{ss}}$ could increase to approximate the input voltage due to no discharging loop. The current in the inductor has changed its direction when S1 is turned OFF. The upper side of the flying capacitor is connected with the input voltage through the body diode of S1. And the bottom side of the flying capacitor is connected with the ground when S4 is turned ON after S1 is OFF. In this case, the flying capacitor will be charged to full input voltage instead of discharging. Due to the symmetrical structure, this case can happen when S1 is turned ON after S3 is OFF. At light load, if the converter loses the ZVS operation for the lagging switch, or even worse, loses ZVS for both leading switch and lagging switch, the mechanisms the same as the ZCS condition. In order to solve this issue, ZVS has to be guaranteed in the three-level converter design for all of its operation conditions, from heavy load to light load. When S2 is turned OFF before S1, the upper side of the flying capacitor is connected to the input voltage through S1 and the lower side of the flying capacitor is connected to the ground through the body diode of S4. Thus, the flying capacitor suffers the full input voltage. In order to solve this problem, the switch sequence has to be assured. Minimal phase-shift is desired to reduce the duty cycle loss when the regulation is through varying frequency instead of the duty cycle. If the abnormally high $V_{c_{ss}}$ is owing to slightly too small phase shift, enlarging the phase shift or paralleling external capacitors in the inner switches is an effective way to solve this problem. However, it should be noted that the increased capacitance on the inner switch will worsen its ZVS condition.

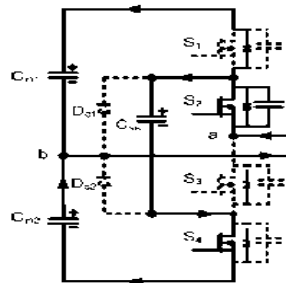

Fig.4. Charging loop for wrong operation mode of ZCS instead of ZVS.

III. MULTIPLE FAULTS IN THE THREE-LEVEL CONVERTER

The behavior of the flying capacitor voltage $V_{c_{ss}}$ under various fault conditions in the three-level parallel resonant converter. The most common faults associated with the active devices and load, including open- or short circuit of main switches S1 and S2, clamping diodes Dc1, anti parallel diodes D1 and D2, rectifier diode Dr1 and load. The anti parallel diodes D1 and D2 short-circuit will be the same as the corresponding main switch short-circuit, only the open circuit of these anti parallel diodes need to be included. When the main switch is MOSFET, its body diode is commonly used as anti parallel diode instead of the external diode. It should be noted that the main switch cannot work properly if its body diode fails. Due to the symmetrical structure, the results will be the same as the counterpart failures occur. To some extent, the fault condition is the worst case of these abnormal conditions. For example, when S2 fails to open circuit, it is like avoiding the rule that S2 should be turned OFF no earlier than S1.

a. Outer Switch Open Circuit

If outer switch (e.g., S1) has an open circuit, the loop is still complete for inductive load current so that the energy in the inductor is transferred to load when S3 and S4 are ON. When the switch the bottom input capacitor, C_{in2} , is continuously transferred to load when S3 and S4 are ON. However, when S3 and S4 are OFF and S2 turns ON, the upper input capacitor (C_{in1}) will be isolated because the upper clamping diode (Dc1) will provide a short-circuit loop for the inductor current. But the energy in the bottom input capacitor, C_{in2} , will gradually discharge to 0, as does $V_{c_{ss}}$. The transformer will be saturated soon due to negative biased dc voltage stress.

International Journal of Innovative Research in Science, Engineering and Technology

(An ISO 3297: 2007 Certified Organization)

Vol. 4, Special Issue 13, December 2015

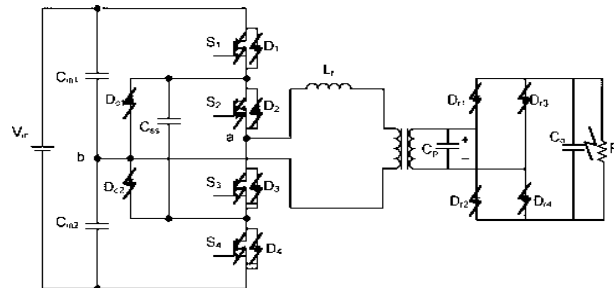

Fig.5. Possible faults on the three-level parallel resonant converter

B. Outer Switch Short Circuit

If S1 has a short circuit, the flying capacitor will be directly connected with input power source when S3 and S4 are ON. V_{c55} is equal to full input voltage, as does S2. But the neutral point voltage would not be influenced by this fault.

C. Inner Switch Open Circuit

If S2 has an open-circuit fault, V_{c55} also increases to full input voltage soon. The mechanism is the same as the outer switch short-circuit case, i.e., both violate the rule that S1 has to turn OFF before S2 turns OFF. When S2 fails to open circuit, it means that S2 always turns OFF before S1.

D. Outer Switch Short Circuit

If S1 has a short circuit, the flying capacitor will be directly connected with input power source when S3 and S4 are ON. V_{c55} is equal to full input voltage, as does S2. But the neutral point voltage would be influenced. If S2 has a short circuit, when S3 and S4 turn ON, the flying capacitor will be shorted through S2, and S3 and the bottom input capacitor C_{in2} will be shorted through the upper clamping diode, S2, S3, and S4. Meanwhile, S1 has to withstand full input voltage when it is open. When S3 and S4 turn OFF, the fault does not affect the converter operation as usual and the flying capacitor and C_{in2} will be charged back to half of the input voltage. Hence, the V_{c55} and neutral point voltage are pulses from zero to half of the input voltage with the same frequency as switching frequency. The transformer will be saturated soon due to the positive biased voltage stress.

E. Outer Switch Body Diode Open Circuit

If the switch S1's body diode D1 fails due to open circuit, this fault does not have any effect on the converter operation. As when S4 turns OFF and S3 is still ON, the inductor current will go through the bottom clamping diode back to the resonant tank instead of D1 after the S4's switch capacitor is charged to half of the input voltage and S1's switching is discharged to 0. Even if it is good, the D1 will never be conducted or involved in any commutation. The system is never affected by this fault. Certainly, this fault is undetectable by V_{c55} .

F. Inner Switch Body Diode Open Circuit

If the switch S2's body diode D2 fails due to open circuit, the converter can work when the S1 and S2 are ON. When the S3 turns OFF after S4 turns OFF, the inductor current starts to charge the S3 switch capacitor and discharge the S2's switch capacitor. But the inductor current has no way to go after the S3's switch capacitor is charged to half of the input voltage and S2's switch capacitor is discharged to 0 due to the open circuit of D2. Therefore, S3 will suffer high voltage spike in this fault case. But the V_{c55} keeps the normal value. This fault cannot be detected unless the noise caused by high voltage spike triggers the protection. It is possible in practical application due to the high abnormal noise when ZVS is lost.

G. Clamping Diode Open Circuit

If the clamping diode Dc1 fails due to open circuit, the converter works normally if the converter is ideal. But the converter will practically lose the advantages of the three-level structure without the clamping diode. As long as the switch's voltage stresses are unbalanced, this fault will be detected by V_{c55} .

International Journal of Innovative Research in Science, Engineering and Technology

(An ISO 3297: 2007 Certified Organization)

Vol. 4, Special Issue 13, December 2015

H. Clamping Diode Short Circuit

If the clamping diode D_{c1} fails due to short circuit, the neutral point voltage will be connected with the positive polarity of the input voltage and charged to full input voltage when S_1 is ON, so does flying capacitor. In this case, S_1 suffers huge current when it is ON, or then S_2 suffers over-voltage when it is OFF.

I. Rectifier Diode Open circuit

If the rectifier diode D_{r1} fails due to open circuit, no more energy will be transferred to the load when the resonant capacitor voltage is positive. But the converter keeps transferring the energy to the load when the resonant capacitor is negative. This unbalanced energy transfer will result in a positive dc biased voltage stress to the transformer. The neutral point voltage will decrease to 0 while the V_{css} increases to the full input voltage. It should be noted that the neutral point voltage will increase if the rectifier diode in opposite bridge is open circuit while the V_{css} still increases. Either one could fail before the neutral point voltage and V_{css} reach the input voltage. Meanwhile, the transformer suffers a negative dc bias voltage.

J. Rectifier Diode Short Circuit

If the rectifier diode D_{r1} fails due to short circuit, the resonant capacitor will be shorted when the polarity of the resonant capacitor voltage is negative. More energy can be transferred to the transformer secondary side when S_3 and S_4 are ON. It follows that the neutral point voltage decreases and flying capacitor voltage increases. Same as D_{r1} open-circuit fault case, the neutral point voltage will increase if the rectifier diode in opposite bridge is shorted while the V_{css} still increases.

K. Load Open Circuit

If load open circuit happens, the output voltage will increase significantly due to the PRC inherent boost property. But the converter will operate normally except for high current when the switching frequency is higher than resonant frequency. Otherwise, the converter will lose ZVS operation and the fault will be detected by the increased V_{css} .

L. Load Short Circuit

If load short circuit happens, the converter still keeps the ZVS mode due to the PRC property. Theoretically it cannot be detected by V_{css} . But the turn-OFF current which depends on the switching frequency will increase due to the triangle current waveform. High voltage spike due to high turn-OFF current still may practically trigger the protection with V_{css} detection. The response of V_{css} to load open circuit and load short-circuit may vary in other three-level topologies because the inherent properties of PRC is dominated in these faults. Of all the possible contingencies, the protection against shoot-through is the trickiest one, and is very dependent on the parasitic inductance. In an ideal case, the voltages of the input capacitors and flying capacitors are equal to half of the input voltage without any parasitic inductance even during a shoot through fault. However, since the input wire inductance of the power supply (L_{in}) shown in Fig. 14 is usually very large or at least relatively larger than the parasitic inductance after the input capacitor as well as the relatively larger input capacitance, the V_{css} will be dropped sharply as shoot-through happens.

IV. DESIGN OF PROPOSED PROTECTION CIRCUIT

For three-level structures, balance resistors are needed for the capacitors' voltage balance the connection of balance resistors. R_1 is equal to R_2 , and R_3 is equal to R_6 . In order to have half the input voltage, the sum of R_4 and R_5 is equal to the sum of R_3 and R_6 . For a protection circuit, R_4 and R_5 , with appropriate resistance, can be used as a voltage divider for the sensor of V_{css} . For 600V input voltage, 1W 100 k Ω resistors with 1% tolerance are chosen for R_1 , R_2 , R_3 and R_6 . R_4 is 198 k Ω and R_5 is 2 k Ω as a one hundredth voltage divider. The sensed voltage is processed by a window detector with an isolated auxiliary power supply. The window detector output is transferred to the system controller through a high-speed optocoupler.

International Journal of Innovative Research in Science, Engineering and Technology

(An ISO 3297: 2007 Certified Organization)

Vol. 4, Special Issue 13, December 2015

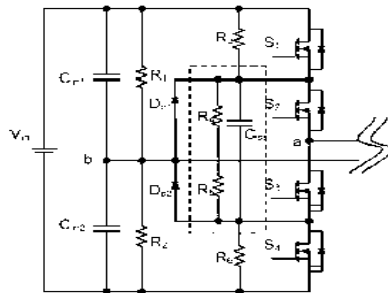

Fig.6.Three-level structure with balance resistors.

A. Flying Capacitor Design

Though the flying capacitor design is not directly related with the protection circuit design, the proposed protection method has to be based on the flying capacitor. In the conventional three-level converter with phase-shift control, the functions of the flying capacitor as decoupling the switching transitions of S1 and S4, S2 and S3, balancing the unbalanced voltages between the two input capacitors, acting as a snubber capacitor for inner switches, S2 and S3.

The decoupling effect is dependent upon on the ratio of capacitance

$$\frac{C_{SS}}{C_{SW}} = \frac{V_{CSS}}{V_{SW}} \quad (1)$$

where V_{sw} is the minimum left voltage of any one of switches

when its gate signal is becoming high during switching transition. ZVS is achieved when V_{sw} is near 0. C_{ss} is the capacitance of flying capacitor. C_{sw} is the sum of the capacitance of the switch capacitor and any external paralleled capacitor. For better decoupling and voltage clamping effect, the capacitance of the flying capacitor should be no less than the calculated number. Even if a phase shift control scheme is not employed and the flying capacitor is not necessary, the flying capacitor can still be added as a snubber capacitor and work for the proposed protection circuit.

B. Design Criteria

The V_{css} is determined by the input voltage in steady-state operation. As the converter is running, the V_{css} is mainly influenced by the voltage ripple of the input capacitors. Due to the clamping diode, the flying capacitor can be charged to the maximum voltage of the input capacitors, while the normal minimum V_{css} is equal to the half of the low-line input voltage.

The duty ratio is given by

$$D = \frac{V_{out} - V_{in}}{V_{out}} \quad (2)$$

The value of capacitor and the inductor can be obtained from the relation below:

$$C = \frac{V_{out} \times D}{f \times \Delta V \times R} \quad (3)$$

ΔV -Ripple voltage (0-10% of output voltage)

f- Frequency

R- Load resistance

C- Capacitance

$$\frac{C_{SS}}{C_{SW}} = \frac{V_{CSS}}{V_{SW}} \quad (4)$$

ΔI -Ripple current (0-20% of the load current)

International Journal of Innovative Research in Science, Engineering and Technology

(An ISO 3297: 2007 Certified Organization)

Vol. 4, Special Issue 13, December 2015

TABLE 1
SIMULATION PARAMETERS OF CONVENTIONAL PFC BOOST CONVERTER

Input Voltage	230V
Transformer turns ratio	11
Resonant Inductor	3.63μH
Resonant Capacitor	1.24nF
Quality factor	4
Flying Capacitor	2μF
Duty ratio	0.6

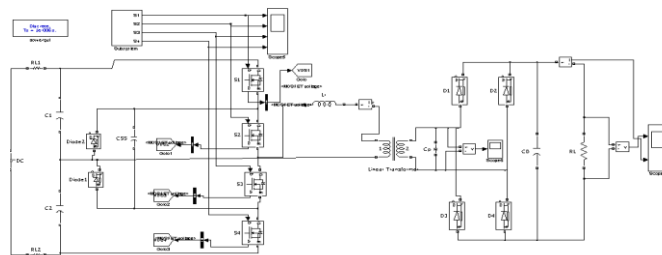

Fig. 7. Simulation of three level dc-dc Converter

IV. SIMULATION RESULTS

The transformer winding over-voltage breakdown results in secondary winding short circuit. The resonant capacitor is discharged to 0 suddenly, which is similar to the case of short circuit of one of rectifier diodes. The voltage stress of the inner switch, S3, immediately increases and is higher than the voltage stress of the outer switching S4. The flying capacitor voltage is also abnormally increased. Therefore, the proposed protection is triggered and successfully protects the converter against the system failure. As the transformer is broken down, the resonant capacitor voltage is discharged to 0. Thus, the resonant inductor current waveform in becomes triangle waveform when the fault happens. In order to verify the analysis and the feasibility of the proposed protection, the scaled-down experiment is operated with 1/10th the input voltage and the same prototype.

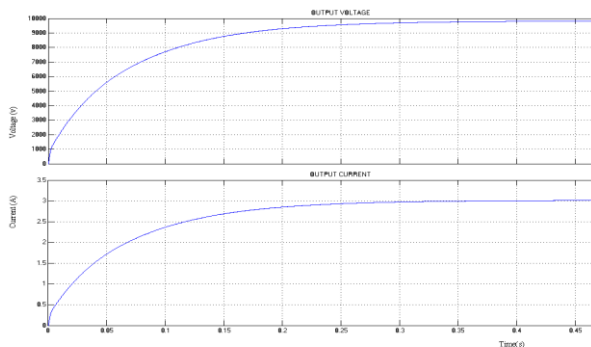

Fig. 8. Input current and voltage waveform of three level dc dc converter

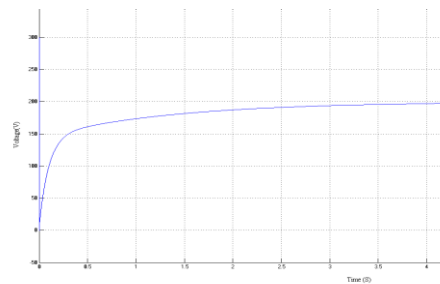

Fig. 9. Flying Capacitor Voltage During Fault Condition

International Journal of Innovative Research in Science, Engineering and Technology

(An ISO 3297: 2007 Certified Organization)

Vol. 4, Special Issue 13, December 2015

The five selected faults respectively: S1 short circuit, S1 open circuit, S2 short circuit, S2 open circuit, and shoot-through. The fault conditions are generated by a timer and a fault signal. The converter enters the steady state before the end of timer. At the end of timer, a fault signal, low level pulse, is added into one of gate signals with a logic AND gate to simulate an open-circuit failure. If the fault signal is a high-level pulse, a short-circuit failure can be simulated when it is added into one of the gate signals through a logic OR gate. If the fault signal is added into all of the gate signals, shoot-through will happen. When the protection circuit is triggered, a shut-down signal (V shutdown) will be generated, which clears the fault signal and shuts down the system.

V. CONCLUSIONS

The proposed protection scheme based on flying capacitor voltage detection. The reasons for the unbalanced voltage stress are categorized. Solutions to each unbalanced voltage stress are introduced. The possible faults are thoroughly analyzed. The proposed protection method can effectively avoid the device failure caused by unbalanced voltage stresses on switches in the three-level structure, and will protect the system even if a failure occurs. Remedies can be taken to prevent the consequent damages of the faults when the new protection method is employed. A detection circuit is proposed, and its design is addressed as well as flying capacitor selection. The theoretical analysis and simulation results are verified by experiment results. The protection scheme is very effective and reliable for three-level converter.

REFERENCES

- [1] J. R. Pinherio and I. Barbi, "The three-level ZVS PWM converter—A new concept in high-voltage dc-to-dc conversion," in *Proc. IEEE IECON Conf.*, Nov. 1992, pp. 173–178.
- [2] X. Ruan, D. Xu, L. Zhou, B. Li, and Q. Chen, "Zero-voltage-switching PWM three-level converter with two clamping diodes," *IEEE Trans. Power Electron.*, vol. 49, no. 4, pp. 790–799, Aug. 2002.
- [3] F. Canales, P. Barbosa, and F. Lee, "A zero voltage and zero current switching three level DC/DC converter," *IEEE Trans. Power Electron.*, vol. 17, no. 6, pp. 898–904, Nov. 2002.
- [4] F. Canales, P. Barbosa, C. Aguilar, and F. C. Lee, "A high-power-density DC/DC converter for high-power distributed power systems," in *Proc. IEEE Power Electron. Spec. Conf.*, 2003, vol. 1, pp. 15–19.
- [5] B.-M. Song, R. McDowell, A. Bushnell, and J. Ennis, "A three-level DC-DC converter with wide-input voltage operations for ship-electric power-distribution systems," *IEEE Trans. Plasma Sci.*, vol. 32, no. 5, pp. 1856–1863, Oct. 2004.
- [6] H. Sheng, W. Shen, H. Wang, and F. Wang, "Design and implementation of high power density three-level parallel resonant converter for capacitor charger," in *Proc. IEEE Appl. Power Electron. Conf.*, Feb./Mar. 2007, pp. 745–749.
- [7] Y. Jang and M. M. Jovanovic, "A new three-level soft-switched converter," *IEEE Trans. Power Electron.*, vol. 20, no. 1, pp. 75–81, Jan. 2005.
- [8] Y. Gu, Z. Lu, and Z. Qian, "Three-level LLC series resonant DC/DC converter," *IEEE Trans. Power Electron.*, vol. 20, no. 4, pp. 781–789, Jul. 2005.