

Design and Analysis of Rear Chassis used in 10Ton Wheel Loader

B G Manjunath ¹, Dr.Narsimha

M.Tech. Student, Department of Mechanical Engineering, Kuppam Engineering College, KES .Nagar, Andhra Pradesh, India¹

Associate Professor & HOD, Department of Mechanical Engineering, Kuppam Engineering College, KES .Nagar, Andhra Pradesh, India²

ABSTRACT: With the increased requirement of accuracy of pay loads, the stiffness characteristics of structure are increasingly influencing the design and performance of wheel loaders. The main objective of structural design is to achieve the minimum mass structure, which will satisfy the stiffness, strength and other requirements. Hence optimum configuration and advanced technology have to be incorporated to achieve minimum mass. At the same time it is required to satisfy all the functional and other requirements of pay load. Optimum design of a rear chassis of wheel loaders structure for mounting on the rear axle of wheel loaders and it is connected to the front chassis wheel loaders through articulation joint was taken up for the study in this project work. The main objective was to design an optimized support structure for meeting the given constraints of geometry and stiffness with minimum mass.

KEYWORDS: Design and Analysis.

I. INTRODUCTION

For any structure to be safe three 'S' factors have to be satisfied. That is Stiffness, Strength and Stability. With the requirement of increased accuracy of payloads, the stiffness characteristics of the structure are increasingly influencing the design and performance of any equipment. The main objective of the structural design is to achieve the minimum mass structure, which will satisfy the stiffness, strength, stability and other requirements. Hence optimum configuration and advanced technology have to be incorporated to achieve minimum mass.

Any structural member subjected to a load, undergoes deformation. Due to this deformation there exists a natural frequency for the body. When the frequency of the structure coincides with the applied loading frequency, resonance occurs. At resonance the amplitude increases largely and can damage or even destroy the structure. Thus the stiffness of the structure should be high.

The second factor to be considered is the strength. The strength of the structure should be in its elastic limits for the structure to be considered to be safe. Strength is the amount of load a structure can take per area or this is the maximum stress a structure can handle.

When these two factors are satisfied, the third factor is automatically satisfied. The structure will be stable if the load is within the elastic limit and the phenomenon of resonance does not exist. Thus the structure will be in equilibrium. So the optimum design of the rear chassis structure should be in such a way that to satisfy all the three above mentioned factors.

International Journal of Innovative Research in Science, Engineering and Technology

(An ISO 3297: 2007 Certified Organization)

Vol. 5, Issue 8, August 2016

II. RELATED WORK

PROBLEM DESCRIPTION

The project work mainly concentrated on the design and analysis of the rear chassis vibratory wheel loaders structure. The support structure design should meet the following requirements.

- The support structure designed should be stiff, strong and light weight.
- It should withstand the applied loads.
- It should support the vibratory mechanism and should give way for the effective operation of other sub structures.

The project work also concentrated on the design and manufacturing of the component articulation joint and front chassis.

DESIGN CRITERIA

The support structure has to satisfy the following design requirements:

- The structure should have a length of 1600mm.
- The structure should have a thickness of 16mm
- It must have fatigue strength less than 350N/mm²
- It should sustain lateral and longitudinal directions loads.
- has to endure all the stresses and strains at the same time meeting the above conditions.

AIM AND SCOPE OF THE PROJECT

This project work is mainly carried out for satisfying the following objectives:

- Conduct various case studies for finalizing the design of rear chassis structure (i.e. Cradle trunnion assembly)
- Carry out static analysis for different support structures with the objective of meeting the required stress constraint.
- Carry out static analysis for the final assembly (support structure and DGA) with the objective of meeting the required deforming and stress constraint static loads in longitudinal and lateral direction.
- Extract the maximum stresses, strains, margin of safety and maximum displacement for the loads.
- Modeling and design of the front chassis component end for connecting the articulation joint.

International Journal of Innovative Research in Science, Engineering and Technology

(An ISO 3297: 2007 Certified Organization)

Vol. 5, Issue 8, August 2016

The modeling and analysis carried out for the manufacturing of the rear chassis using THE CATIA V5 AND ANSYS11 software

III. DESIGN AND FE ANALYSIS OF REAR CHASSIS ASSEMBLY USED IN 10T WHEEL LOADER

MODEL DESCRIPTION:

The Rear Chassis of 10T Wheel Loader is shown in the figure 3.1, 3.2, 3.3 The rear chassis is connected to front chassis through the Articulation joint and to axle by Plate rear axle mounting

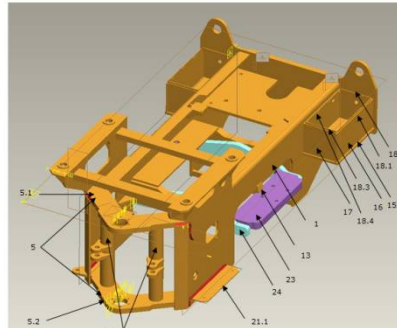

3.1 Rear Chassis Assembly

The finite element analysis was carried out by using the analysis software ansys. the solution procedure is described below.

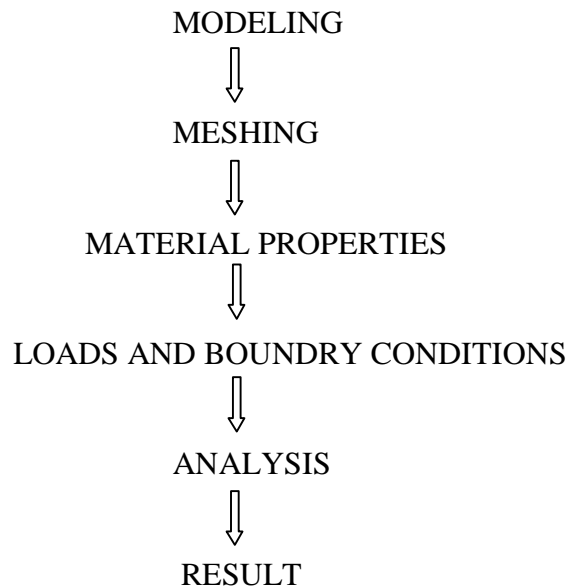

International Journal of Innovative Research in Science, Engineering and Technology

(An ISO 3297: 2007 Certified Organization)

Vol. 5, Issue 8, August 2016

ANALYSIS PROCEDURE:

1. ANALYSIS PREFERENCE: STRUCTURAL (STATIC)

2. ELEMENTS USED :

| Element | Remarks |
|-----------------------------------|---|
| SOLID92 (10 noded tetrahedral) | DOF available: UX, UY, UZ SOLID 92 elements are giving better accuracy for the model with irregular shapes. |
| MASS21 (1-mass noded) | DOF available: UX, UY, UZ, Rot X, Rot Y, Rot Z Used for introducing additional rotation DOF to solid elements at the Trunnion pivot. |
| SURF154 (8-noded) | DOF available: UX, UY, UZ Used to define the reaction forces of pin as surface loads |

Table 3.1

REAL CONSTANTS:

- For SURF154 element, unit thickness is given in all the nodes
(TKI = TKJ =TKK = TKL = 1)
- For MASS21 element, unit mass is given in all the directions
(MASSX = MASSY =MASSZ = 1)

MATERIAL PROPERTIES :

Elastic modulus = 2.1 x 10⁵ N/mm²
Poisson's ratio = 0.3

FE MODEL DETAILS :

Ladder mounting bracket and suction mounting block are suppressed for the analysis
Mesh the model using SOLID92 element
The additional Rotational DOF is provided at the Trunnion pivot by giving constraint Equation between Solid 92 and Mass 21 as shown Fig 3.2

BOUNDARY CONDITION:

- The Translation DOF (UX, UY, UZ) is arrested at the bottom side of Plate rear axle mounting (23)
- The additional Rotational DOF is provided at the Trunnion pivot by giving constraint Equation between Solid 92 and Mass 21 as shown Fig 3.2

International Journal of Innovative Research in Science, Engineering and Technology

(An ISO 3297: 2007 Certified Organization)

Vol. 5, Issue 8, August 2016

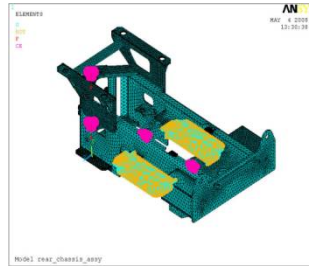

Fig.3.2 Boundary condition for rear chassis assembly

LOADING CONDITION:

Load1: Articulation Joint

a) Radial load of 70500 N is applied on top and bottom plate rear pivot individually.

| S.no | Load | Area mm ² | Force, N | Pressure, N/mm ² |
|------|----------------------------------|----------------------|----------|-----------------------------|
| 1 | Articulation joint (Radial load) | 6891.87 | 70500 | 10.2 |

b) Axial load of 12.7 KN is applied at the axis of the top and bottom plate rear pivot individually at digging condition.

| S.no | Load | Area mm ² | Force, N | Pressure, N/mm ² |
|------|---------------------------------|----------------------|----------|-----------------------------|
| 1 | Articulation joint (Axial load) | - | 12735 | - |

Load2: Steering cylinder

The Compressive load acting radially towards the cylinder mounting (reaction) of 100530 N is resolved into two components (F_x and F_y) and applied as surface load (pressure) along X and Y directions.

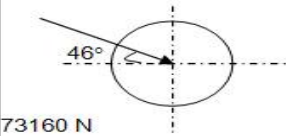
| S.no | Load | Area(A) mm ² | Force, N | | Pressure, N/mm ² | |
|-------|--|-------------------------|-------------------------|--------------------------|-----------------------------------|-----------------------------------|
| | | | F _x =F cos θ | F _y = F sin θ | P _x =F _x /A | P _y =F _y /A |
| 6.2.1 |  <p>73160 N</p> | 3404.18 | 50821.2 | 52626.8 | 14.9 | 15.4 |

International Journal of Innovative Research in Science, Engineering and Technology

(An ISO 3297: 2007 Certified Organization)

Vol. 5, Issue 8, August 2016

The Tensile load acting radially towards the cylinder mounting (reaction) of 75400 N is resolved into two components (F_x and F_y) and applied as surface load (pressure) along X and Y directions.

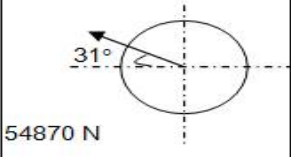
| S.no | Load | Area(A) mm ² | Force, N | | Pressure, N/mm ² | |
|-------|--|----------------------------|-----------------------|-----------------------|-----------------------------|---------------|
| | | | $F_x = F \cos \theta$ | $F_y = F \sin \theta$ | $P_x = F_x/A$ | $P_y = F_y/A$ |
| 6.2.2 |  54870 N | 3404.18 | 47032.7 | 29076.67 | 13.8 | 8.3 |

Load3: Loads due to Self weight of the mounting components

The Vertical downward load acting on the rear chassis due to the self weight of the mounting components.

| S.no | Loading Entity | Area mm ² | Force, N | Pressure, N/mm ² |
|------|----------------|-------------------------|----------|-----------------------------|
| 1 | Engine | 12719.02 | 2060 | 0.16196 |
| 2 | Transmission | 6858.00 | 3050 | 0.45 |
| 3 | Counter Weight | 54854.89 | 12000 | 0.22 |
| 4 | Cabin | 4465.33 | 1750 | 0.39 |
| 5 | Radiator | 1912.26 | 450 | 0.24 |
| 6 | Fuel Tank | 1357.2 | 440 | 0.32 |
| | | | 1210 | 0.89 |

International Journal of Innovative Research in Science, Engineering and Technology

(An ISO 3297: 2007 Certified Organization)

Vol. 5, Issue 8, August 2016

| | | | | |
|---|----------------|----------|------|--------|
| 7 | Hydraulic Tank | 70118.57 | 2000 | 0.028 |
| 8 | Battery Mount | 166900 | 430 | 0.0025 |
| 9 | Hood | 125431 | 1500 | 0.0119 |

Table 3.2

The following loads are acted on the rear chassis. The areas at which the loads are acting are taken from CATIA V5model as shown Fig 3.4.

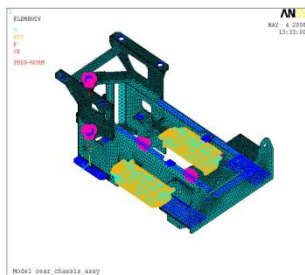

Fig.3.4 Loading condition for the rear chassis assembly

IV. RESULTS

REARCHASSIS STRUCTURE

The displacement vector plot and von mises stress plot are shown in

- Fig.4.1
- Fig.4.2
- Fig.4.3
- Fig.4.4
- Fig.4.5
- Fig.4.6 and
- Fig.4.7. The following findings are obtained:

The Maximum deflection is 5.5 mm on the Plate cabin mounting bracket (19.1).

The maximum value of von mises stress is 486.36 N/mm² at the weld between Side plate rear frame (1) and Top plate rear pivot (5.1). The high stress is due to stress singularity error.

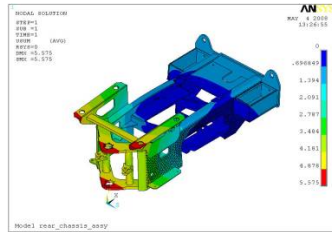

Fig. 4.1 Deformation plot for rear chassis

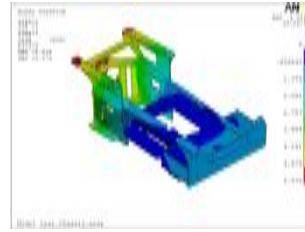

Fig. 4.2 Deformation plot for rear chassis

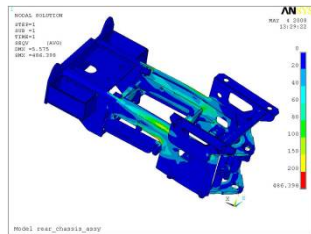

Fig. 4.3 Von mises Stress plot for rear chassis

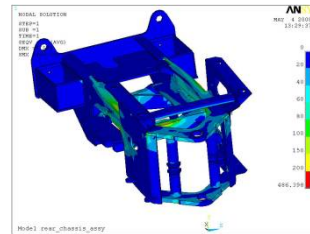

Fig. 4.4 Von mises Stress plot for rear chassis

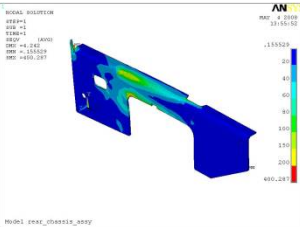

Fig. 4.5 Von mises Stress plot for rear chassis

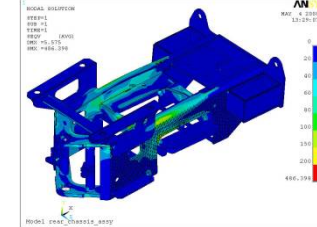

Fig. 6.5 Von mises Stress plot for rear chassis

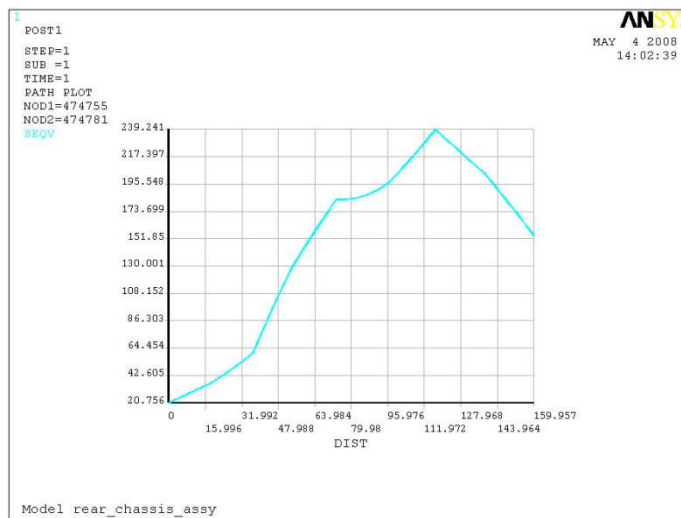

Fig. 6.9 Graphical plot of curved section

International Journal of Innovative Research in Science, Engineering and Technology

(An ISO 3297: 2007 Certified Organization)

Vol. 5, Issue 8, August 2016

IV. CONCLUSION

In this project work, for designing a stiff, strong and weight support structure for the wheel loader machines, various configurations like Bar Trunnion, Rear plate pivot, Top plate rear pivot, Bottom plate rear pivot, Fuel Tank Mounting Plate, Engine Mounting Bracket Assembly (LH&RH), Engine plate Mounting, Engine Support Mounting (2 nos.), Steering Column Assembly (LH&RH), Column rear chassis Top plate steering anchor, Bottom plate steering anchor, Plate Trunnion, type support structures were considered. Normal static analysis was carried out for finding out the deformation and stress of the structure.

From the analysis it was understood that cardle trunnion bar structure is stiffer than other parts. But the wheel loader structure consists of so many sub systems and components and the space required for other structure is more and from the study. After designing structure, various parametric studies have been done for improving the deformation and stress of the structure. The deformation and stress are obtained from the static analysis was acceptable. Thus the design of the rear chassis assembly structure satisfies the stiffness and stress requirement.

The linear static analysis was carried out for the launch loads for finding out the maximum stress, strain and displacement developed in the structure and the margins were established from this.

The other component rear chassis for connecting the front chassis support through the articulation joint structure to also modeled during this project work using the CATIA V5wildfire software.

REFERENCES

- [1] R.D. Cook and John Wiley and sons "Concepts and Application of FE analysis"
- [2] Robert M.Jones, "McGraw-Hill Book Co.Ltd Mechanics of Composite Materials",1975
- [3] Finite Element Modeling (2005) Ansys User's Guide and Reference Manual.
- [4] William T.Thomson, "Theory of vibration with applications", Prentice Hall.
- [5] D.H.Pahr, Institute of Lightweight Design and Structural Biomechanics,Vienna University of Technology, Austria, Materials Science Forum Vols. 539-543 pp. 2467-2472,2007.
- [6] John. E.Higgins and James L.Harvey, Development of low cost lightweight tooling for large composite structures, 48 th AIAA,vol 8,2007.
- [7] Prof.I.Verpoest and Dr.J.Pflung, Investigation of a new Core-Skin Bonding Concept for Structures, 2002.
- [8] Thirupathi R.Chathrupatla and Ashok D. Belegundu, "Introduction to Finite Elements in Engineering", Prentice Hall, London.
- [9] S.Ramamrutham andR.Narayan "Strength of Materials", Dhanpat Rai and Sons
- [10] www.vitkovicemachinery.com/en/references/steel-structures-and-constructions.
- [11] www.aarokohonen.com.
- [12] www.lindab-buildings.com/steelstructure.
- [13] www.steelstructures.co.za.
- [14] www.engineeringtalk.com/guides/earth-moving-equipment.