

Performance Analysis of Speed Control of Hybrid Electric Vehicle

Vishvas Kumar¹, Dr. D.K. Tanti²

M.Tech Student, Department of Electrical Engineering, B.I.T Sindri, Dhanbad, Jharkhand India¹

Associate Professor, Department of Electrical Engineering, B.I.T Sindri, Dhanbad, Jharkhand India²

ABSTRACT: The aim of this paper is to control the speed of nonlinear Hybrid Electric Vehicle by controlling the throttle position. Various conventional controllers such as Proportional-integral-derivative (PID), internal model controller (IMC), and IMC-PID with fractional filter controllers have been designed. Some intelligent controllers e.g. self-tuning fuzzy PD controller and self-tuning fuzzy PID controllers have also been designed. The objective is to give smooth throttle movement, zero steady-state speed error, and to keep up a Selected Vehicle (SV) speed. A comparative analysis has been carried out in order to identify the superiority of control technique so as to get improved fuel economy, reduced pollution, improved driving safety and reduced manufacturing costs.

KEYWORDS: HEV, PID, IMC, IMC-PID with fractional filter, Self-tuning fuzzy logic PD, Self-tuning fuzzy logic PID

I. INTRODUCTION

In recent years, the population has increased the demand of conventional internal combustion Engine vehicle (ICEV). Due to heavy demand of ICEV, pollution has increased causing greenhouse effect leading to global warming. For this reason, automobile industries developed HEV, which combines with the Electrical engine and IC engine for delivering the propulsion power. HEV is the very popular now-a-day because of fuel economy and better vehicle Performance. These vehicles have less emission, higher passenger comfort, and increased safety. The modern electric vehicle performance depends very much on automation system applied. There are different types of controllers to get the optimized response for any system. PID is one of the effective conventional controllers that has been used from a long time back. Ziegler-Nichols (ZN) tuning method for PID controller is a popular tuning process [3]. The disadvantage of PID controller is that it is not suitable for higher order nonlinear system. IMC controller is used to decrease the disturbance of the system and to make the system internally stable [6-8]. IMC-PID with fractional filter provides more flexibility in controller design as compared with standard PID controllers [9-10]. Self-tuning Fuzzy PD and self-tuning Fuzzy PID controllers are intelligent controllers that use IF and THEN rule to get optimized result [11-13].

II. MATHEMATICAL ANALYSIS

. Figure-1 shows a schematic diagram of the electronic throttle control using a DC servo motor and the Simulink model is shown in Figure-2

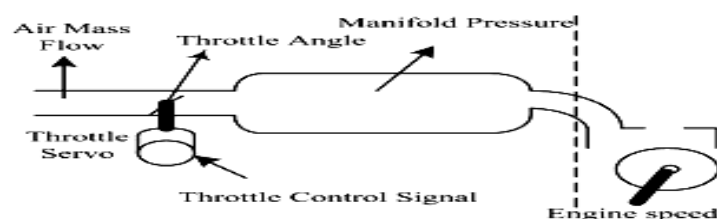

Figure-1 Schematic diagram of electronic throttle control

International Journal of Innovative Research in Science, Engineering and Technology

(An ISO 3297: 2007 Certified Organization)

Vol. 5, Issue 8, August 2016

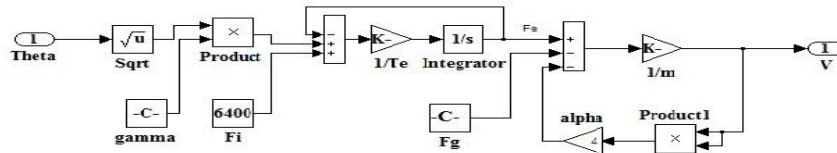

Figure-2 Simulink model of Hybrid Electric Vehicle

The relationship between engine force, gravity induced force, throttle angle and vehicle speed has been derived as:-

$$m \frac{dv}{dt} = F_e(\theta) - \alpha v^2 - F_g \quad (1)$$

$$\tau_e \frac{dF_e(\theta)}{dt} = -F_e(\theta) + F_{e1}(\theta) \quad (2)$$

$$F_{e1}(\theta) = F_i(\theta) + \Upsilon \sqrt{\theta} \quad (3)$$

Where,

F_e = Engine force, a function of the throttle position

F_g = Gravity induced force, a function of the road grade

θ = Throttle position

v = Vehicle speed

Assumption

- 1) Gravity induced force (F_g) is 30% of the weight of the vehicle.
- 2) Engine time constant commonly lie between 0.1 to 1 sec., here we take 0.2 s.

TABLE-1
NUMERICAL VALUES OF HEV

Constant	Notation	Value(SI Unit)
Vehicle mass	m	1000Kg
Drag coefficient	α	$4 \text{ N}/(\text{m/s})^2$
Engine force coefficient	Υ	12500 N
Engine idle force	F_i	6400 N
Engine time constant	τ_e	0.2 Second

The MATLAB command 'linmod2' is to obtain linear models from systems of ordinary differential equations described as Simulink models-(2)in [2] and here the same command is used obtained state space variable of nonlinear hybrid electric vehicle shown in equation (4), and then transfer of the hybrid electric vehicle shown in equation (5).

State space variable:-

$$A = \begin{bmatrix} 0 & 0.001 \\ 0 & -5 \end{bmatrix}, B = \begin{bmatrix} 0 \\ 8.29 * 10^8 \end{bmatrix}, C = [1 \quad 0], D = [0] \quad (4)$$

Transfer function:

$$\frac{V(s)}{\theta(s)} = \frac{829000}{s(s+5)} \quad (5)$$

The characteristic equations of system is $|\lambda I - A| = 0$, whence we get the eigenvalues as $\lambda_1 = 0, \lambda_2 = -5$. The system is found controllable and observable, as the order of matrix M and N is equal to rank = 1.

$$M = 829000 * \begin{bmatrix} 0 & 1 \\ 1 & -5 \end{bmatrix}, N = \begin{bmatrix} 1 & 0 \\ 0 & 1 \end{bmatrix} \quad (6)$$

International Journal of Innovative Research in Science, Engineering and Technology

(An ISO 3297: 2007 Certified Organization)

Vol. 5, Issue 8, August 2016

Open loop response of HEV using step input

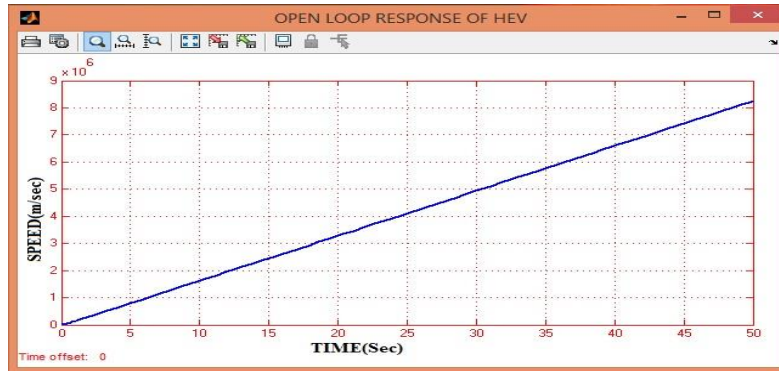

Figure-3 Output response of open loop HEV

The response of open loop HEV using step input shows that HEV is nonlinear in nature.

III. CONTROL TECHNIQUE

Different control technique such as PID, IMC, IMC-PID with fractional filter, self-tuning fuzzy PD and self-tuning fuzzy PID controllers used to control the speed of HEV.

PID CONTROLLER

The actuating signal for the PID controller and the transfer function are given in equation (7) and (8).

$$c(t) = K_p e(t) + K_i \int e(t) dt + K_d \frac{de(t)}{dt} \quad (7)$$

$$C(s) = K_p + \frac{K_i}{s} + K_d s = K_p \left(1 + \frac{1}{T_i s} + T_d s \right) \quad (8)$$

Where: K_p = Proportional gain, K_i = Integral gain, T_i = Reset time = $\frac{K_p}{K_i}$, K_d = Derivative gain, T_d = Rate Time or derivative time = $\frac{K_d}{K_p}$. Where, K_p , K_d , and K_i , all non-negative, denote the coefficients for the proportional, integral, and derivative terms, respectively (sometimes denoted P, I, and D).

Manual PID tuning

In manual PID tuning method is to first set K_i and K_d values to zero. Increase K_p until the output of the loop oscillates, and then K_p should be set to approximately half of that value for a "quarter amplitude decay" type response. Then increase K_i until any offset is corrected in sufficient time for the process. However, too much K_i cause instability. Finally, increase K_d , if required, until the loop is acceptably quick to reach its reference after a load disturbance. However, too much K_d will cause excessive response and overshoot. A fast PID loop tuning usually overshoots slightly to reach the set point more quickly; however, some systems cannot accept overshoot, in which case an over-damped closed-loop system is required, which will require a K_p setting significantly less than half that of the K_p setting that was causing oscillation.

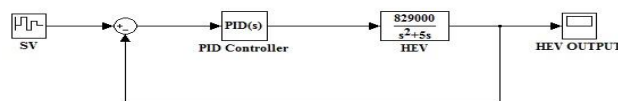

Figure-4 Simulink Model of HEV with PID Controller

International Journal of Innovative Research in Science, Engineering and Technology

(An ISO 3297: 2007 Certified Organization)

Vol. 5, Issue 8, August 2016

INTERNAL MODEL CONTROLLER

The IMC philosophy relies on the internal model principle, which states that Accurate control can be achieved only if the control systems encapsulates (either implicitly or explicitly) some representation of the process to be controlled.

A controller $G_c(s)$ is used to control the process $G_p(s)$. Suppose $G_p^*(s)$ is a model of $G_p(s)$. By setting $G_c(s)$ to be the inverse of the model of the process,

$$G_c(s) = G_p^*(s)^{-1} \tag{9}$$

If $G_p(s) = G_p^*(s)$, (the model is an exact representation of the process), it is clear that the output will always be equal to the set point. Notice that this ideal control Performance has achieved without feedback.

First, the factor $G_p^*(s)$ divided into “invertible” and “non-invertible” components.

$$G_p^*(s) = G_p^*(+)(s) G_p^*(-)(s) \tag{10}$$

Where, $G_p^*(+)(s)$, contains terms which if inverted, will lead to instability and reliability problems, e.g. terms containing right-half plane zeros and time delays, and also these lead to marginal stability (have real part equal to zero) and $G_p^*(-)(s)$ is the remaining part such that its inverse is stable.

In addition, $G_p^*(+)(s)$ is required to have a steady-state gain equal to one in order to ensure that the two factors $G_p^*(+)(s)$ and $G_p^*(-)(s)$ are unique.

Next, set $G_c(s) = G_p^*(-)(s)$ and then

$$G_{IMC}(s) = G_c(s) G_f(s) \tag{11}$$

Where, $G_f(s)$ is an appropriate order low-pass filter.

The transfer function model for the HEV system has given below:

$$G_p(s) = \frac{829000}{s(s+5)} \tag{12}$$

Here $G_p(s) = G_p^*(s)$ then;

$$G_p^*(s) = \frac{829000}{s(s+5)} \tag{13}$$

$G_{IMC}(s)$ is designed as follows; the factorization is

$$G_p^*(s) = G_p^*(+)(s) G_p^*(-)(s) \tag{14}$$

Where

$$G_p^*(-)(s) = \frac{829000}{s(s+5)} \tag{15}$$

And

$$G_p^*(+)(s) = 1 \tag{16}$$

Next, set $G_{IMC}(s)$ to be the inverse of $G_p^*(-)(s)$ in series with a low-pass filter

$$G_f(s) = \frac{1}{(1+\lambda s)^n} \tag{17}$$

Where, λ the filter parameter is and n is the order of the filter. That is,

$$G_{IMC}(s) = \frac{s(s+5)}{829000(1+\lambda s)^n} \tag{18}$$

The filter of order n has selected to make $G_{IMC}(s)$ proper and λ is an adjustable parameter that determines the speed-of-response.

In IMC Controller when $n=2$ and $\lambda=1/20$ then it gives optimum output of the HEV

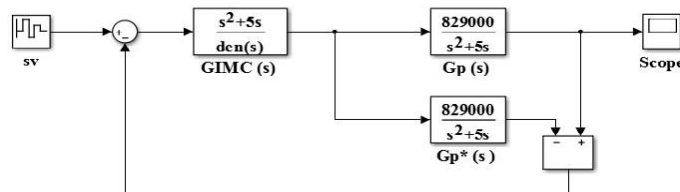

Figure-5 Simulink block of IMC for HEV

International Journal of Innovative Research in Science, Engineering and Technology

(An ISO 3297: 2007 Certified Organization)

Vol. 5, Issue 8, August 2016

IMC-PID-FRACTIONAL-ORDER-FILTER CONTROLLER

According to CRONE principle, the fractional property of the controller is introduced by the fractional reference model $G_f(s)$. To obtain the iso-damping property then

$$G_f(s) = \frac{1}{1+\lambda s^{n+1}}, \quad 0 < n < 1 \quad (19)$$

The standard feedback controller $C(s)$ is

$$C(S) = \frac{G_{IMC}(s)}{1-G_{IMC}(s)G_p^*(s)} \quad (20)$$

The controller $C(s)$ can be put in the form of an integer PID structure cascaded with a fractional filter $H(s)$.

$$C(S) = H(S). K_p(1 + \frac{1}{T_i s} + T_d s) \quad (21)$$

PID parameters are K_p is the gain, T_i is the integral time constant, T_d is the derivative time constant, and $H(s)$ is the fractional part of the controller.

Assume that the plant is described by

$$G_p(s) = \frac{K}{s(1+Ts)} \quad (22)$$

Then IMC controller is

$$G_{IMC}(s) = \frac{S(1+TS)}{K(1+\lambda s^{n+1})} \quad (23)$$

The corresponding feedback controller is given by

$$C(s) = \frac{S(1+TS)}{K\lambda s^{n+1}} \quad (24)$$

With is written as

$$C(s) = \frac{1}{s^n} \frac{1}{K\lambda} (1 + TS) \quad (25)$$

$C(s)$ is a classical PD controller cascaded with the fractional integrator $\frac{1}{s^n}$.

The transfer function of HEV is

$$G_p(s) = \frac{829000}{s(s+5)} \quad (26)$$

The transfer function of HEV may also be written as-

$$G_p(s) = \frac{165800}{s(1+0.2s)} \quad (27)$$

Now compare with equation (22) to (27) then

$K=165800$ and $T=0.2$

The value of K and T are put in equation (25) then we get

$$C(s) = \frac{1}{s^n} \frac{1}{165800\lambda} (1 + 0.2S) \quad (28)$$

Equation (25) compares with equation (28) then we get

$$H(S) = \frac{1}{s^n}, \quad K_p = \frac{1}{165800\lambda} \quad \text{and} \quad T_d = 0.2$$

PID parameters are K_p is the gain, T_i is the integral time constant, T_d is the derivative time constant, and $H(s)$ is the fractional part of the controller.

In IMC-PID with fractional filter Controller when $n=0.025$ and $\lambda=1/20$ then it gives optimum output of the HEV

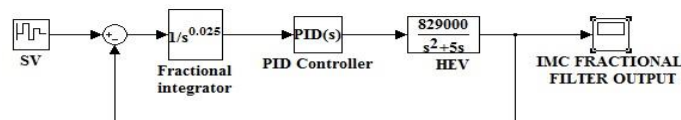

Figure-6 Output Response of HEV with IMC-PID fractional filter

International Journal of Innovative Research in Science, Engineering and Technology

(An ISO 3297: 2007 Certified Organization)

Vol. 5, Issue 8, August 2016

FUZZY LOGIC CONTROLLER

Fuzzy logic controller based on a linguistic control strategy, which has derived from expert knowledge into an automatic control strategy. The fuzzy logic controller does not need any difficult mathematical calculation as the others control system. A fuzzy logic model is a logical-mathematical procedure based on an “IF-THEN” rule.

A fuzzy rule system has four modules.

- Fuzzification
- Fuzzy Inference
- Rule base
- Defuzzification

The process of converting a crisp variable into a linguistic variable is known as Fuzzification. Under inference, the truth-value for the premise of each rule has computed and applied to the conclusion part of each rule. Under rule base, Mamdani based “If Then” generally used to obtain the output. Defuzzification is a process in which crisp variable output has been obtained by the fuzzy variable.

Self-tuning fuzzy PD controller

In this design three-membership functions namely, Negative Medium (NM), Zero (ZE) and Positive Medium (PM) have defined. For the inputs ‘E’ and ‘DE’, all membership functions are triangular. For the output ‘KP’ and ‘KD’, all membership functions are triangular. The range of values for Input ‘E’ and ‘DE’ is [0 1] and output ‘KP’ and ‘KD’ is [0 0.2]. Different ‘If-Then’ rules connecting the three variables has been developed.

TABLE-2

Rule base for self-tuning Fuzzy-PD controller

E \ DE	NM	Z	PM
NM	NM	NM	Z
Z	NM	Z	PM
PM	Z	PM	PM

The Simulink block set for self-tuning fuzzy PD controller implemented for speed control of HEV shown in Figure-7

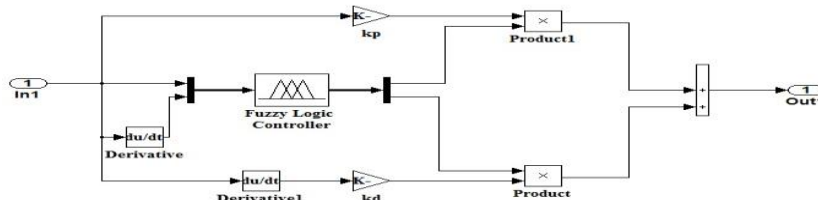

Figure-7 Simulink block of self-tuning Fuzzy PD Controller

The Simulink block of HEV using self-tuning Fuzzy PD controller subsystem shown in Figure-8

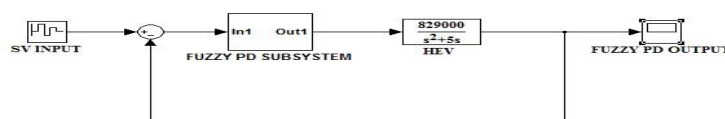

Figure-8 Simulink block of HEV using self-tuning fuzzy PD Controller

International Journal of Innovative Research in Science, Engineering and Technology

(An ISO 3297: 2007 Certified Organization)

Vol. 5, Issue 8, August 2016

Self-tuning fuzzy PID controller

Self-tuning fuzzy PID controller denotes that the three parameters K_p , K_i and K_d of PID controller have been tuned by using the fuzzy tuner. Regarding the Fuzzy structure, there are two inputs to Fuzzy inference: error $e(t)$ and derivative of error $de(t)$, and three outputs for each PID controller parameters respectively K'_p , K'_i and K'_d . Mamdani model is applied as the structure of Fuzzy inference with some modification to obtain the best values for K_p , K_i and K_d . Suppose the ranges of the parameters K_p , K_i and K_d of PID controller are respectively $[K_{p\ min}, K_{p\ max}]$, $[K_{i\ min}, K_{i\ max}]$ and $[K_{d\ min}, K_{d\ max}]$. The range of each parameter was determined based on the simulation on PID controller to obtain a feasible rule base with high inference efficiency.

For the output, fuzzy set, the scaling of range have been done corresponding to the formulas given below:

$$K'_p = \frac{K_p - K_{p\ min}}{K_{p\ max} - K_{p\ min}}$$

$$K'_i = \frac{K_i - K_{i\ min}}{K_{i\ max} - K_{i\ min}}$$

$$K'_d = \frac{K_d - K_{d\ min}}{K_{d\ max} - K_{d\ min}}$$

The Fuzzy variable levels have assigned as NB: negative big; NM: negative minimum; ZE: zero; PM: positive minimum; PB: positive big. The ranges of inputs from -1 to 1 and output ranges from 0 to 1.

TABLE - 3
Rule base for self-tuning Fuzzy-PID controller

e de	NB	NM	Z	PM	PB
NB	NB	NB	NB	NM	Z
NM	NB	NB	NM	Z	PM
Z	NB	NM	Z	PM	PB
PM	NM	Z	PM	PB	PB
PB	Z	PM	PB	PB	PB

The Simulink block set of self-tuning fuzzy PID controller implemented for speed control of HEV shown in Figure-9.

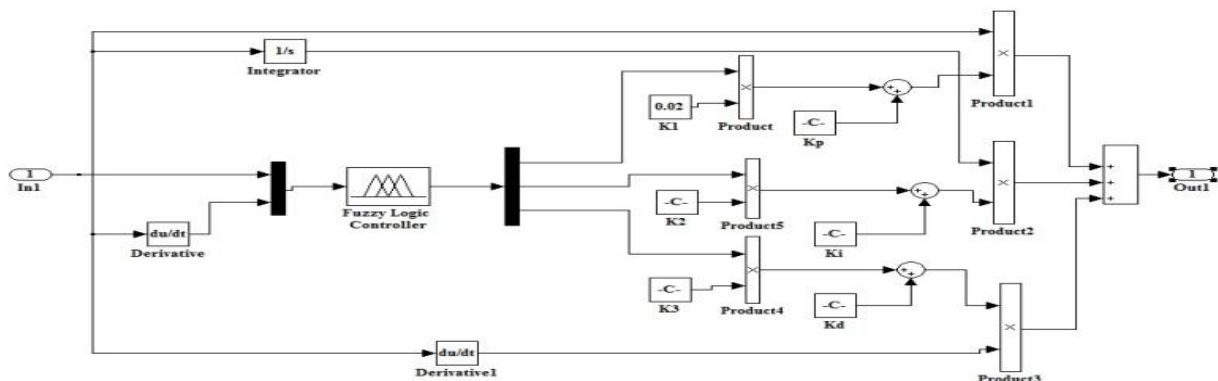

Figure-9 Self-tuning Fuzzy-PID controller

International Journal of Innovative Research in Science, Engineering and Technology

(An ISO 3297: 2007 Certified Organization)

Vol. 5, Issue 8, August 2016

The Simulink block of HEV using self-tuning Fuzzy PID subsystem has been shown in Figure-10

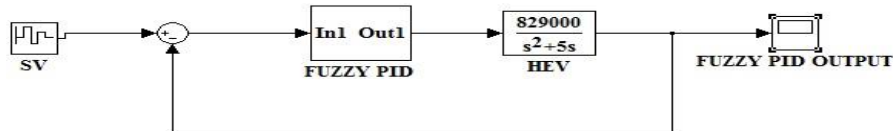

Figure-10 Simulink Block of HEV using self-tuning Fuzzy PID

IV. EXPERIMENTAL RESULTS

Performance analysis of HEV with PID, IMC, IMC-PID with fractional filter, Self-tuning Fuzzy PD and Self-tuning Fuzzy PID have been shown in Figure-11.

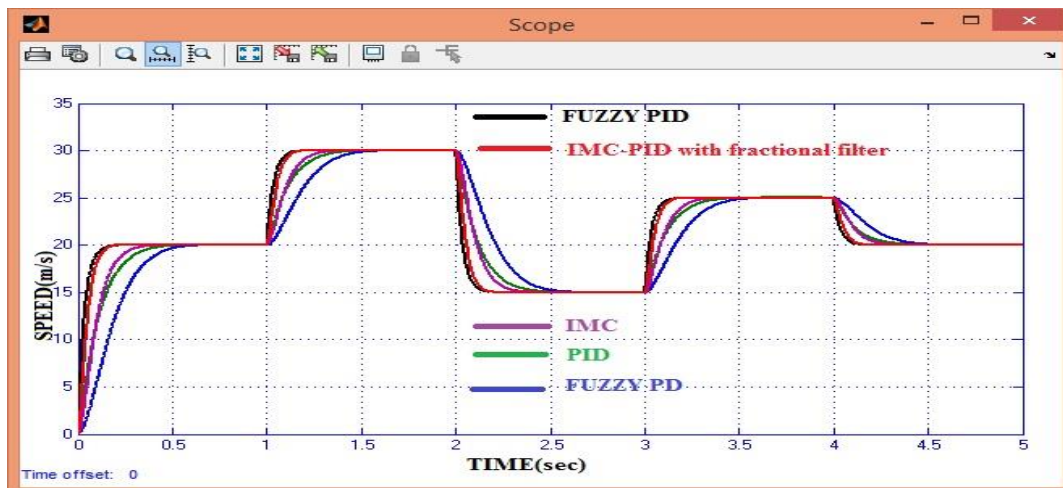

Figure-11 Combined Response of the controllers

As per the response of all the above controllers Rise Time, settling time, percentage overshoot and steady state error shown in table-4.

TABLE-4
PERFORMANCE INDEX OF CONTROLLERS

Controller	Rise Time	SettlingTime	%Over-shoot	SteadyState Error
PID	0.23	0.5295	0	0
IMC	0.174	0.445	0	0
IMC-PID with fractional filter	0.086	0.2	0	0
Fuzzy PD	0.280	0.59	0	0
Fuzzy PID	0.0722	0.197	0	0

It is found that Self-tuning Fuzzy PID Controller has lowest settling time, Rise time and zero % overshoot and steady state error.

International Journal of Innovative Research in Science, Engineering and Technology

(An ISO 3297: 2007 Certified Organization)

Vol. 5, Issue 8, August 2016

V. CONCLUSION

A combined performance analysis of all the controllers applied to control the speed of the nonlinear hybrid electrical vehicle has been done and it has been observed that the Self-tuning Fuzzy PID controller gives better performance than the other controllers and provides lowest rise time, settling time and %overshoot. Thus, it is concluded that self-tuning Fuzzy PID is the best controller among the aforementioned conventional and intelligent controllers for the present work. The self-tuning Fuzzy PID control technique may be applied to other similar nonlinear system for performance optimization. Vehicle drive train efficiency of HEV may be improved with self-tuning Fuzzy PID controller.

REFERENCES

- [1] Anil Kumar Yadav, Prerna Gaur and Alok Mittal, "Optimal Speed Control of Hybrid Electric Vehicles" research gate/publication/264064193, 2011.
- [2] Anil Kumar Yadav and Prerna Gaur, "Robust adaptive speed control of uncertain hybrid electric vehicle using electronic throttle control with varying road grade". Springer DOI 10.1007/s11071-013-1128-9.
- [3] Stuart Bennett, "A Brief History of Automatic Control" 0272 -1708/96/1996 IEEE.
- [4] KiamHeongAng, Gregory Chong, and Yun Li, "PID Control System Analysis, Design, and Technology" IEEE transaction on control system technology, VOL. 13, NO. 4, JULY 2005.
- [5] M. Gopal, Digital Control and State Variable Methods Conventional and Intelligent Control System, Tata Mcgraw Hill Education Pte.Ltd., Third Reprint, Chap. 7, 2009.
- [6] Ahmed S. Abd, El-Hamid and Ahmed H. Eissa, "Position Control of AC Servomotor Using Internal Model Control Strategy" International Journal of Engineering Innovation & Research, Volume 4, Issue 2, ISSN: 2277 – 5668.
- [7] Jan Swevers, "Internal model control (IMC)" e-book July 2006.
- [8] Alf Isaksson, "Model-based control design" e-book, September 1999.
- [9] BettayebMaâmar and MansouriRachid, "IMC-PID-fractional-order-filter controllers design for integer order systems" 0019-0578/ 2014 ISA. Published by Elsevier Ltd.
- [10] T. Vinopraba, N. Sivakumaran, S. Narayanan and T. K. Radhakrishnan, "Design of internal model control based fractional order PID controller" Springer-Verlag Berlin Heidelberg 2012. DOI 10.1007/s11768-012-1044-4.
- [11] P D AdityaKarthik, J Supriyanka, "Design of Self-tuning PID controller using Fuzzy Logic for Level Process" IJESRT, ISSN: 2277-9655, June-2014.
- [12] Vikram Chopra, Sunil K. Singla and Lillie Dewan, "Comparative Analysis of Tuning a PID Controller using Intelligent Methods" Acta Polytechnic Hungarica Vol. 11, No. 8, 2014.
- [13] M. G. uzelkaya, 'I. Eksin* and E. Ye, sil, "Self-tuning of PID-type fuzzy logic controller coefficients via relative rate observer" 0952-1976/03/2003 Elsevier Ltd.