

## International Journal of Innovative Research in Science, Engineering and Technology

(An ISO 3297: 2007 Certified Organization)

Vol. 5, Special Issue 9, May 2016

# Automation Testing Tool for Doppler Weather RADAR

Anirudh Bhat K<sup>1</sup>, Pradeep Kumar C<sup>2</sup>, Durga Prasad<sup>3</sup>

M.Tech Student, Dept. of Electronics and Communication, NMAM Institute of Technology, Nitte, Udupi District,  
Karnataka, India<sup>1</sup>

Scientist/Engineer, Radar Development Area, ISTRAC, ISRO, Bengaluru, Karnataka, India<sup>2</sup>

Associate Professor, Dept. of Electronics and Communication, NMAM Institute of Technology, Nitte, Udupi District,  
Karnataka, India<sup>3</sup>

**ABSTRACT:** Doppler Weather Radar (DWR) subsystems are usually tested on radar site by feeding inputs manually using signal generators and recording the output on the oscilloscope, thus needing more resources and testing time. In this project an automated testing tool is designed by taking advantage of remote nature of equipment's used for testing. The setup consists of vector signal generator as input to radar and spectrum/signal analyzer as output which are remotely connected via Ethernet Local Area Network (LAN) to a Personal Computer (PC) system and are controlled with help of MATLAB and Standard Commands for Programmable Instruments (SCPI) commands using Virtual Instrument Software Architecture (VISA) driver, on a remote location.

**KEYWORDS:** DWR testing, signal generator, spectrum analyzer, SCPI, VISA.

### I. INTRODUCTION

DWRs are utilized to perceive the existence of precipitation contained in the atmosphere. Different precipitation forms are interpreted as derived (processed) products of DWR. But, the precision of these outputs depends on how well the radar subsystems have been calibrated. Thus, before arriving at the output, DWR has to be tested with respect to various ranges of inputs, subsystems, parameters etc. [1,2], to analyze the working of the radar subsystems and to calibrate them for required application. To perform these tests this project considers design of an automated, remotely controlled and programmed test tool. The primary feature of this tool is to control the test equipment based on SCPI commands and acquire the outputs arrived at the subsystem for various test cases designed.

### II. RELATED WORKS

Design of test setup is carried out based on the works carried out while testing manually like, parameters considered while designing of the radar subsystem like dynamic range of the receiver, bandwidth of the subsystem, intermediate frequency (IF) channel bandwidths, resolution bandwidth (RBW), video bandwidth (VBW) etc [1,2,6].

### III. TESTSETUP DESIGN

To evaluate these parameters, certain test cases have to be performed considering individual radar subsystem. Thus, based on these factors the test setup is designed as shown in Figure 1.

Considering the test setup, radar subsystem is fed with the input signal through signal generator i.e. Rohde and Schwarz SMB 100A. The parameters like frequency, power level, bandwidth etc., generating the input is passed using SCPI commands from the PC display system to the signal generator via Ethernet LAN cable. Once the radar processes the input signal, the spectrum analyzer i.e., Rohde and Schwarz spectrum analyzer FSV captures the output and displays the output power spectrum corresponding to the input [3].

# International Journal of Innovative Research in Science, Engineering and Technology

(An ISO 3297: 2007 Certified Organization)

Vol. 5, Special Issue 9, May 2016

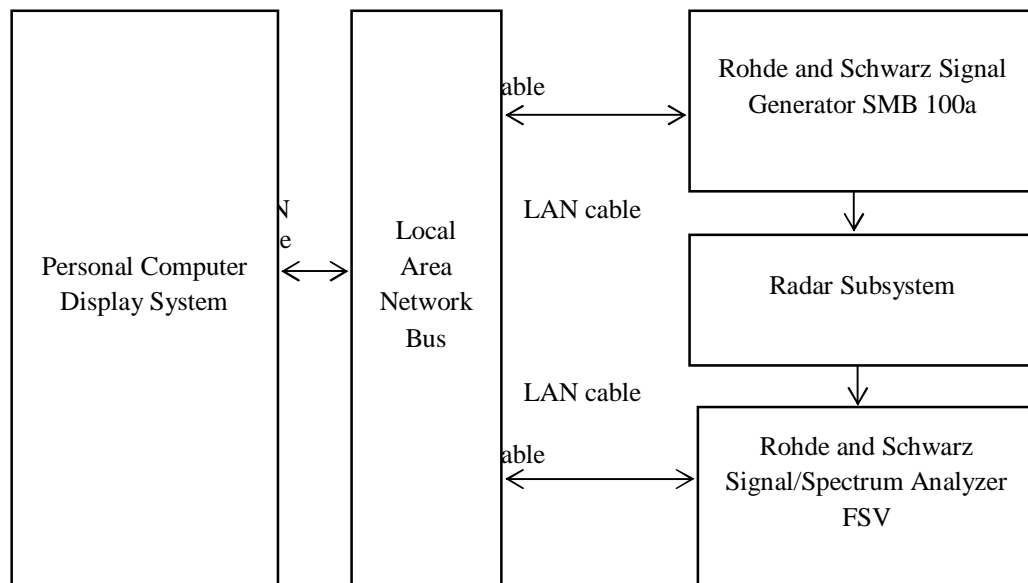

Figure 1: Test Setup for testing radar subsystem

## IV. PREREQUISITES AND PRINCIPLE OF WORKING

### REQUIREMENTS:

1. Signal Generator: Used as input to the radar subsystem [4].

Features of signal generator R&S SMB 100A:

- Frequency Range-10 Hz to 6 GHz.
- Modulation Techniques: Amplitude, Frequency, Phase and Pulse.
- Has RF Mode which is used to convey message signal information.
- Can be remotely operated using SCPI commands.

2. Signal/ Spectrum Analyzer: Used as acquiring unit to obtain the radar output [5].

Features of signal analyzer R&S FSV:

- Frequency Range-3.2kHz to 4 GHz.
- Can be used to Analyze Dynamic Range, RBW, and VBW.
- Used to Analyze the RF spectrum.
- Can be remotely operated using SCPI commands.

3. Virtual Instrument Software Architecture (VISA) :

- Driver software used to create virtual environment while connecting instruments.
- Behaves as a platform to transfer SCPI commands via TCP / IP protocol from PC to the instrument and also from instrument to PC Display system.
- In this project VISA from Tektronix i.e. TekVISA shown in Figure 2, is utilized to connect the signal generator and signal analyzer to the PC display system via Ethernet LAN.

# International Journal of Innovative Research in Science, Engineering and Technology

(An ISO 3297: 2007 Certified Organization)

Vol. 5, Special Issue 9, May 2016

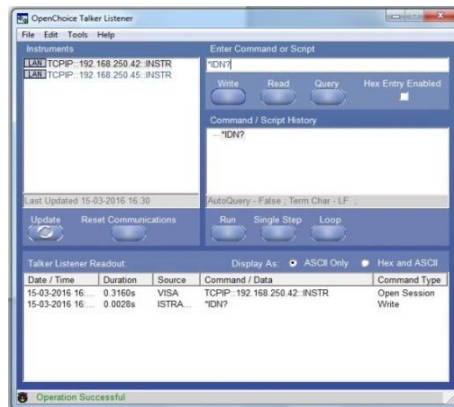

Figure 2: TekVISA interface after connecting instruments

## PROCEDURE:

- Initially the test setup is configured as shown in the Figure 1.
- The instruments connected to the PC display are verified for connectivity using MATLAB/SCPI commands as,  

$$\text{query}(\text{tcpobject}, '*IDN?');$$
- In response to this command the instrument responds by sending its instrument name and id as shown in Figure 3,

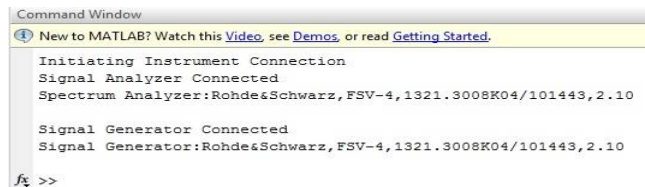

Figure 3: MATLAB command prompt output for instrument query

- Once the instruments are connected the input is supplied to the signal generator with the help of the Radar Automation Test tool simulator as shown in Figure 5.
- This simulator is a graphic user interface application created with MATLAB and SCPI commands. It contains all the functions of signal generator and signal analyzer which helps in controlling these instruments remotely and thus helps in setting the parameters of the instrument via simulator.

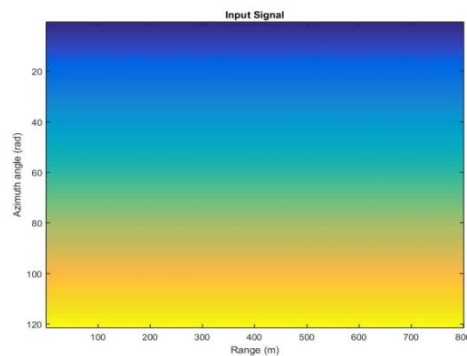

Figure 4: Test case input signal applied to the radar through test tool

# International Journal of Innovative Research in Science, Engineering and Technology

(An ISO 3297: 2007 Certified Organization)

Vol. 5, Special Issue 9, May 2016

6. Finally a test case as shown in Figure 4 containing different radar parameters and different inputs in an Excel sheet is supplied as an input to the simulator through MATLAB code and the instruments are configured as per the test case and radar subsystem testing is carried out.
7. At last the spectrum analyzer passes all the output to the display PC and the plots for different parameters like dynamic range of the receiver, bandwidths, etc. are visualized.

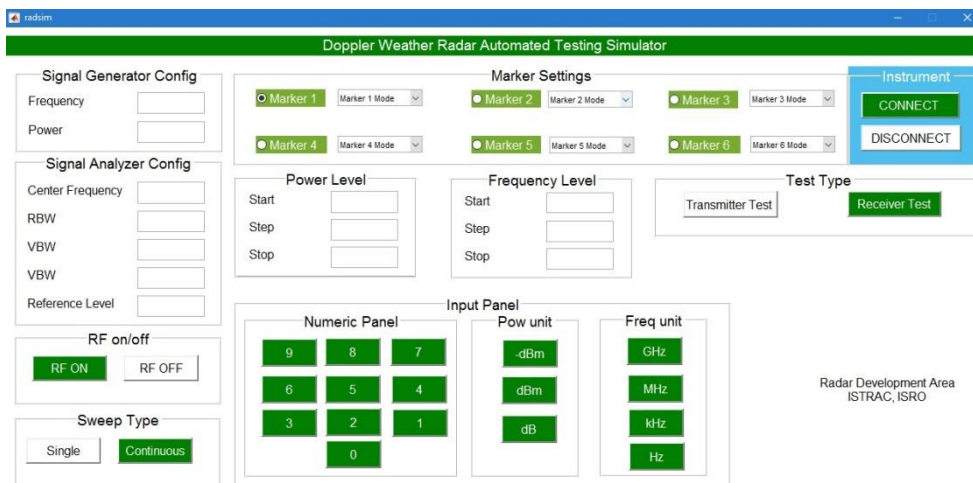

Figure 5: Radar testing simulator

## V. RESULTS

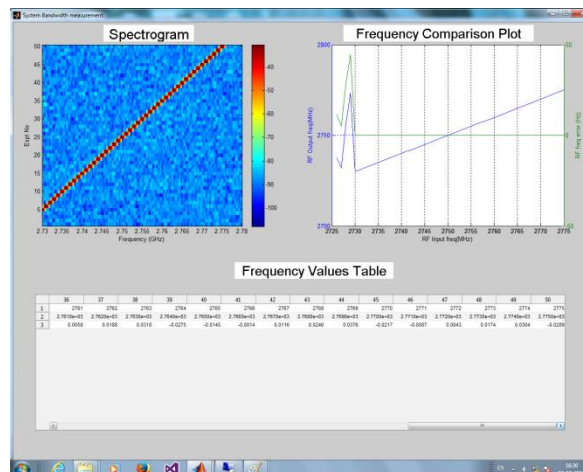

Figure 6: Testing Bandwidth of the subsystem

Test cases performed for system bandwidth and dynamic range of the receiver using the automated test tool are shown in Figure 6 and Figure 7 which verifies that the system is having a bandwidth of 2.73 GHz to 2.78 GHz, similarly it is found that the dynamic range of the receiver is around 50 dB.

# International Journal of Innovative Research in Science, Engineering and Technology

(An ISO 3297: 2007 Certified Organization)

Vol. 5, Special Issue 9, May 2016

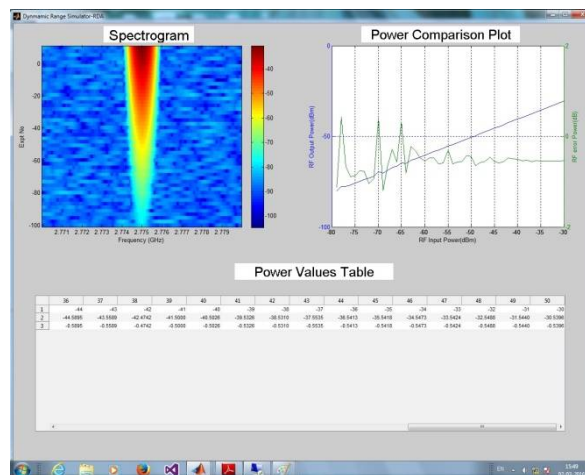

Figure 7: Testing Dynamic Range of the subsystem

Also from Figure 8, the spectrum analyzer output of the system is obtained via SCPI commands which verifies the compatibility of MATLAB / SCPI for the given test setup.

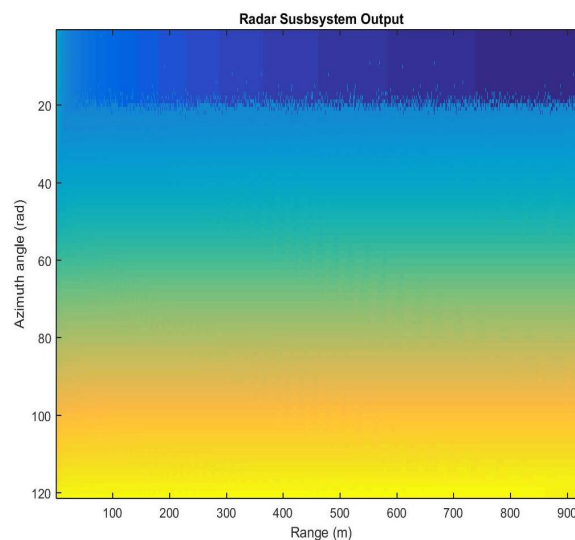

Figure 8: Output of radar using test setup

Finally for the test case given in Figure 4, the output obtained in the radar is found to be identical as shown in Figure 8, but with some noise, which is acquired with the help of the test setup and the simulator designed.

## VI. CONCLUSION

The system designed here can be used for various types of testing radar subsystem. These tests can be performed in fewer amounts of time and cost with high accuracy. Also one can use the test results obtained for radar data analysis and correction so that the precision of the radar can be increased valuably. Since the test setup operates remotely these can be performed away from the radar site and controlling can be done efficiently.

# International Journal of Innovative Research in Science, Engineering and Technology

*(An ISO 3297: 2007 Certified Organization)*

**Vol. 5, Special Issue 9, May 2016**

## REFERENCES

- [1]. Ren Mingqiu, CaiJinyan, Zhu Yuanqing and Han Zhuangzhi, "Design of radar ECCM performance testing system and its semi-physical simulation experiment," Radar (Radar), IEEE CIE International Conference on, Chengdu, pp. 1058-1062, 2011.
- [2]. R. Lefevre, R. Durand, R. Satterfield, A. MacMullen, J. Walker and G. Pollon, "Smart repeater for radar testing," IEEE Systems Readiness Technology Conference., Salt Lake City, pp. 611-614, 1998.
- [3]. V. Gupta, "Latest trends in radar system testing," in IEEE Aerospace and Electronic Systems Magazine, Vol. 23, pp. 20-25, 2008.
- [4]. Rohde and Schwarz SMB 100a, Signal generator programming manual.
- [5]. Rohde and Schwarz FSV, Spectrum analyzer programming manual.
- [6]. Merrill I. Skolnik, "Introduction to Radar Systems", 3rd edition, The McGraw-Hill Companies, 2003.