

Analysis of Delamination in Carbon Fibre Reinforced Polymer Composite using Finite Element Method

Shahabaz S M^{1*}, Rakesh Kumar², Nagaraj Shetty³, Sharma S.S⁴P.G. Student, Dept. of Mech. Engg., Manipal University Jaipur, Jaipur, India¹Assistant Professor, Dept. of Mech. Engg., Manipal University Jaipur, Jaipur, India²Assistant Professor, Dept. of Mech. & Mfg. Engg., Manipal Institute of Technology, Manipal University, Manipal, India³Professor, Dept. of Mech. & Mfg. Engg., Manipal Institute of Technology, Manipal University, Manipal, India⁴

ABSTRACT: Composite laminates such as carbon fibre reinforced polymer (CFRP), glass fibre reinforced polymer (GFRP) and fibre metal composite laminates (FMLs) are being widely used in aerospace and automotive industry. The demand for these materials is increasing due to their superior properties such as high strength to weight ratio, good corrosion resistance and high stiffness. Drilling is a major process in manufacturing of holes which is required for assembling the components in industry. Drilling of holes in CFRP leads to a drilling induced damage called delamination. The researchers have tried to reduce the drilling induced damage by minimizing the operating variables and tool design. However the research on delamination analysis using finite element method is limited. This research paper includes the designing of drill bit using 3D modeling software CATIA V5.0 and the composite material is modeled using finite element analysis (FEA) software ANSYS V14.5. Analysis is carried out for various spindle speed, point angle and feed rate.

KEYWORDS: Carbon Fibre Reinforced Polymer (CFRP), Drilling, Delamination, Finite Element method (FEM).

I. INTRODUCTION

Composite materials are gaining their importance in every industry such as aircraft, spacecraft, automobile, marine applications due to their mechanical properties such as high strength to weight ratio, high modulus to weight ratio, high damping capacity, good dimensional stability, excellent damage tolerance and good corrosion and fatigue resistance [1-3]. Composite materials are fabricated to their near net shape by autoclave moulding, compression moulding, pultrusion, hand lay-up and filament winding [4-6]. Amongst the different types of polymers like, fibre reinforced polymers (FRP), glass fibre reinforced polymer (GFRP), fibre metal composite laminates (FMLs), metal matrix composites (MMCs) and ceramic matrix composites (CMCs), carbon fibre reinforced polymers (CFRPs) are used most, in manufacturing of automobiles and aeronautical applications due to its high mechanical properties [7-10]. Conventional machining operations such as turning, milling, drilling, orthogonal cutting [11-16] and non-traditional machining processes such as laser cutting, water jet cutting, ultrasonic cutting and electric discharge machining [17-21] is used in manufacturing of holes, to achieve dimensional accuracy and to obtain high surface finish during machining of composite materials. High abrasiveness, anisotropy, heterogeneity are some of the material properties of composites, due to these properties they make difficulty in machining operation. During machining of composites due to their high abrasive nature, material damages such as fibre pull out, burr formation, hole shrinkage and delamination occurs, which results in high losses for manufacturing industries. About 60% of losses occur in manufacturing industries due to drilling induced delamination [22]. Delamination is the main problem which occurs during drilling of carbon fibre reinforced polymer which makes difficulty in assembling of components [23]. Feed rate, cutting velocity and drill bit

International Journal of Innovative Research in Science, Engineering and Technology

(An ISO 3297: 2007 Certified Organization)

Vol. 5, Special Issue 9, May 2016

geometry are the different parameters which has an influence on the drilling induced damage [24]. Many researchers have tried to optimize these parameters to reduce delamination.

Drilling plays an important role in producing holes in CFRP laminates. Feed rate and thrust force are the important parameters which causes delamination in CFRP materials. As the thrust force and feed rate increases delamination increases and as the thrust force and feed rate is decreased, delamination decreases. To overcome this, Tsao et al. [25] investigated drilling in CFRP by applying active back up force to reduce delamination. It was found that by applying back up force delamination was reduced to 75%. And at higher cutting speed, there was reduction in torque and thrust force which resulted in improved surface finish of the composite laminate. Increase in cutting speed and decrease in feed rate led to the decrease in thrust force and better surface finish was obtained by Hamzeh et al. [26] during the investigation of drilling in carbon fibre reinforced thermoset laminates. Experiment was carried out by using different type of drills such as twist drill, saw drill, candle stick drill and step drill by Hocheng and Tsao [27]. Twist drill was found to be more influenced on delamination of CFRP compared to other types of drill.

Many researchers have experimentally conducted analysis of drilling induced delamination in composites by conventional method. However, delamination analysis using finite element method is limited. Experimental and simulation process was carried out in drilling of fibre reinforced plastic by Rakesh et al. [28]. Analysis on fibre reinforced composite laminate was done using twist drill, jodrill and trepanning tool. Geometry of drill was modeled by using Pro-E software and simulation was conducted using ABAQUS software. Conclusion was made that more influence on delamination was caused by twist drill during drilling of FRP laminate compared to other drills and the experimental results and simulation results were found to be in a good agreement with each other. Delamination factor was determined by Singh et al. [29] during the investigation of drilling of uni-directional glass fibre reinforced polymer. Twist drill was modeled for different point angles and the behavior of the point angles on thrust force was studied. It was found that as the feed rate and point angle was increased, thrust force and delamination factor was increased. The experimental results and simulation results were found to be comparatively similar. Analysis on drilling induced delamination on CFRP was done by Ozden and Elaheh [30]. Step drill and twist drill was modeled for the experiment by using SOLID WORKS software. During analysis, carried out in ABAQUS software it was found that twist drill had more impact on torque and thrust force compared to that of the step drill.

Many researchers have tried to minimize the drilling induced delamination by various different approaches, but the delamination effect has not been completely reduced. The present work provides delamination analysis carried out on drilling of carbon fibre reinforced laminate. Effect of feed rate, spindle speed and point angle on delamination is evaluated using ANSYS software.

II. EXPERIMENTAL INVESTIGATION

a. Modeling of drill bit

Twist drill was modeled using modeling software CATIA V5.0 for 4 mm and 6 mm diameter. Material of drill bit used was high speed steel (HSS). Length of the drill was kept as 100 mm and flute length was kept as 65 mm, according to the literature survey. Drill geometry was designed for point angle of 90°, 104° and 118° and it was saved in IGES format so that it can be imported into ANSYS software for the analysis purpose. The specification of drill geometry for HSS material is shown in Table 1. Fig. 1 shows 3D solid model of drill bit for 4 mm and 6 mm diameter with a point angle 90°. Similarly for point angle 104° and 118° was designed in same software CATIA.

Table 1
Specification of twist drill geometry

Drill Diameter (mm)	4	6
Density (kg/m ³)	7700	7700
Helix Angle (°)	27	27
Point Angle (°)	90, 104, 118	90, 104, 118
Pitch (mm)	24.66	36.99
Clearance Diameter (mm)	3.6	5.6

International Journal of Innovative Research in Science, Engineering and Technology

(An ISO 3297: 2007 Certified Organization)

Vol. 5, Special Issue 9, May 2016

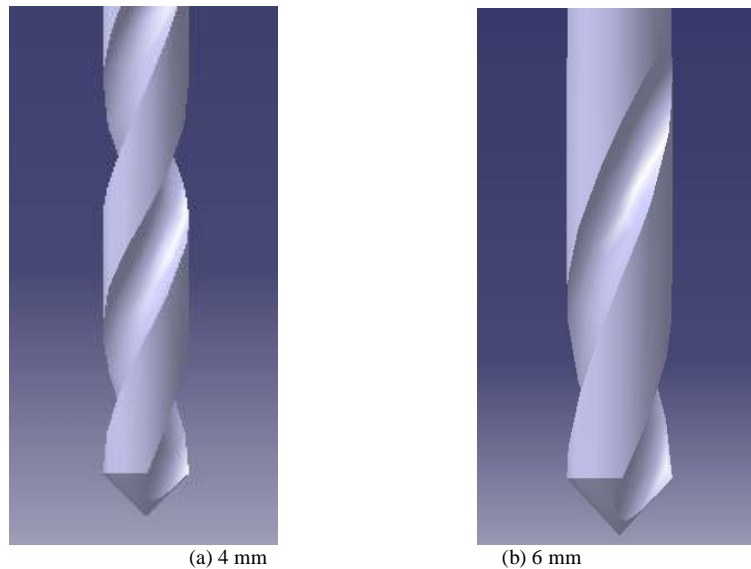

Fig. 1. 3D model of twist drill

b. Modeling of composite laminate

Uni-directional carbon fibre reinforced (UD-CFRP) composite laminate ply was modeled in ANSYS Workbench software with a 0/90° fibre orientation. Size of 20×20×4 mm UD-CFRP square plate with a pilot hole of 0.5 mm diameter was modeled with 8 prepreg layers of thickness 0.5 mm each, as shown in Fig. 2. Pilot hole was designed to avoid the interaction of chisel edge of twist drill with the work piece so that the simulation time could be reduced.

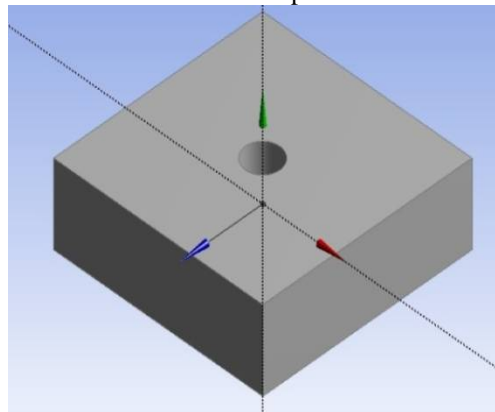

Fig. 2. 3D model of uni-directional CFRP

Table 2

Von-mises stress obtained for various feed rates and spindle speed.

Drill Diameter (mm)	Point Angle (°)	Feed Rate (mm/rev)	Spindle Speed (Rpm)	Von-Mises Stress (MPa)
4	90	0.5	100	52.136
		1	500	66.312
		2	1000	156.64
		3	1500	216.14
6	90	0.5	100	147.12
		1	500	244.04

		2	1000	306.36
		3	1500	507.51
4	104	0.5	100	60.831
		1	500	73.014
		2	1000	109.29
		3	1500	282.79
		6	104	0.5
		1	500	392.02
		2	1000	414.6
		3	1500	600.97
4	118	0.5	100	116.95
		1	500	194.46
		2	1000	339.8
		3	1500	517.82
6	118	0.5	100	160.65
		1	500	323.87
		2	1000	513.61
		3	1500	643.64

c. Meshing and Boundary conditions

Meshing and analysis was carried out in ANSYS Workbench V14.5. Explicit dynamic analysis was done for various ranges of feed rate and spindle speed and their respective von-mises stresses were noted as shown in Table 2. Twist drill modeled using CATIA was imported into ANSYS software by IGES format and the material properties of HSS was assigned to the drill bit. Twist drill was made rigid for the analysis purpose. Carbon fibre reinforced polymer material properties were assigned to the workpiece and was made flexible so that the deformation can be observed. Default meshing was done for the workpiece and twist drill, with a mesh type of tetra/hexa. Total number of nodes and elements generated were 8194 and 8239. Workpiece was fixed supported from the bottom as well as on the either two sides, and for the twist drill remote displacement was given as the boundary condition. The delamination and deformation of the material can be seen in Fig. 3 for 6 mm diameter.

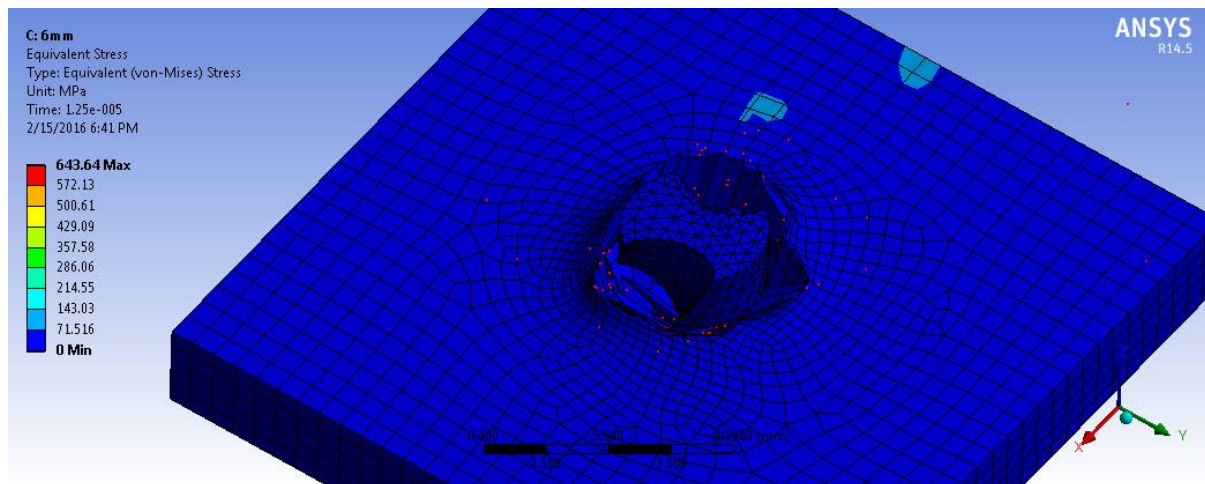

Fig. 3. Delamination for drill diameter of 6 mm with point angle of 118°

International Journal of Innovative Research in Science, Engineering and Technology

(An ISO 3297: 2007 Certified Organization)

Vol. 5, Special Issue 9, May 2016

III. RESULTS AND DISCUSSIONS

As the stress increases, drilling induced delamination in composite material also increases. It can be seen from Table 2 that, with increase in feed rate and spindle speed von-mises stress increases and point angle also has influence on the stress occurring in the material. Feed rate vs von-mises stress graphs as shown in Fig. 4(a, b, c) were plotted for point angles of 90°, 104° and 118°. From the graphs shown below, it is observed that, as the feed rate increases stress increases and the maximum stress is found for the 118° point angle for 6 mm drill diameter at the spindle speed of 1500 rpm with the feed rate of 3 mm/rev. Similarly spindle speed vs von-mises stress graphs were plotted and same results were obtained as shown in Fig. 5(a, b, c). It is observed that, stress obtained for 4 mm diameter was minimum compared to that of 6 mm diameter. Hence drill diameter also plays an important role in delamination on composite laminates.

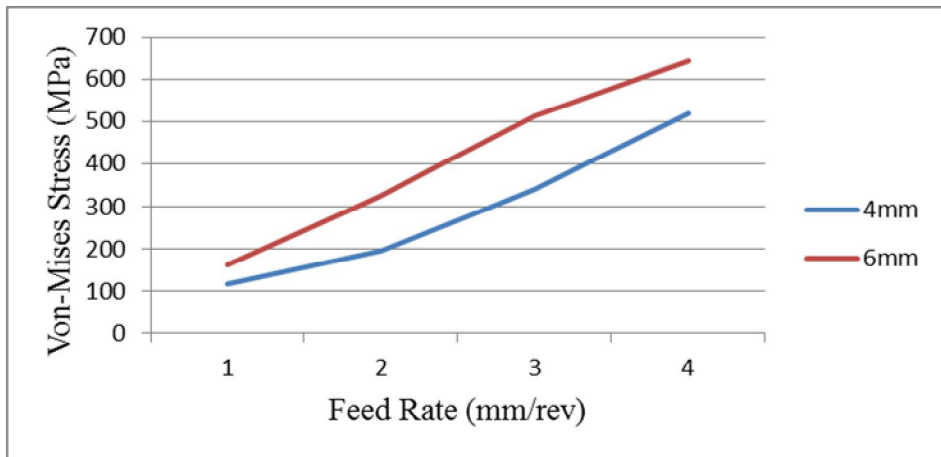

(a) 90° point angle

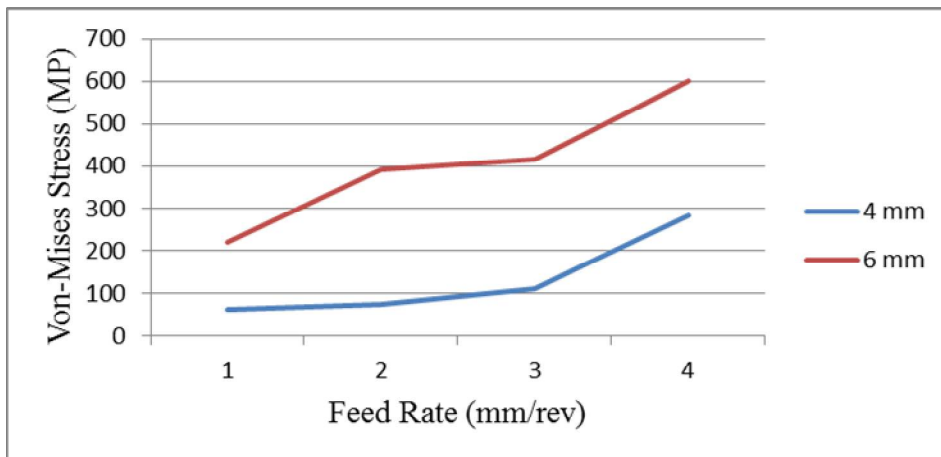

(b) 104° point angle

International Journal of Innovative Research in Science, Engineering and Technology

(An ISO 3297: 2007 Certified Organization)

Vol. 5, Special Issue 9, May 2016

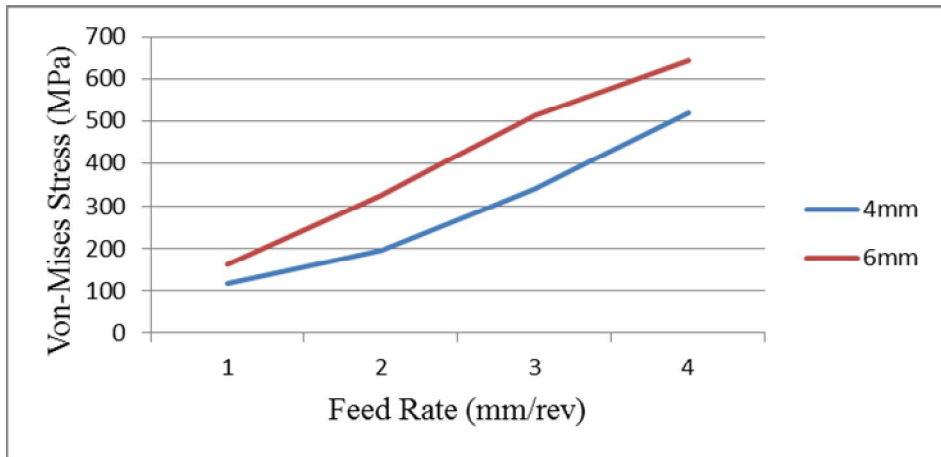

(c) 118° point angle

Fig. 4. Feed rate Vs Von-Mises stress

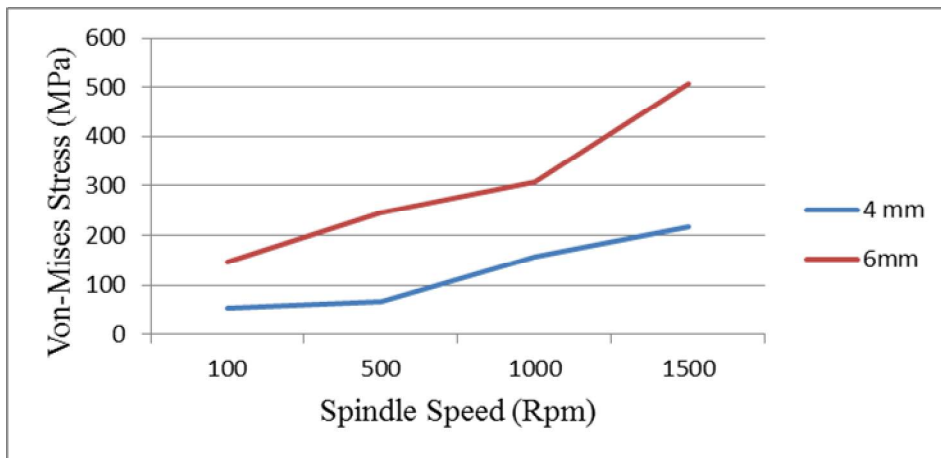

(a) For 90° point angle

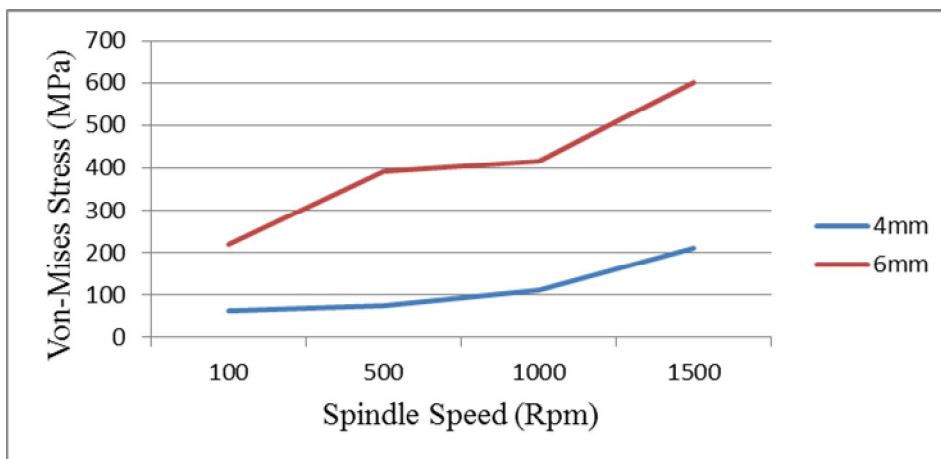

(b) For 104° point angle

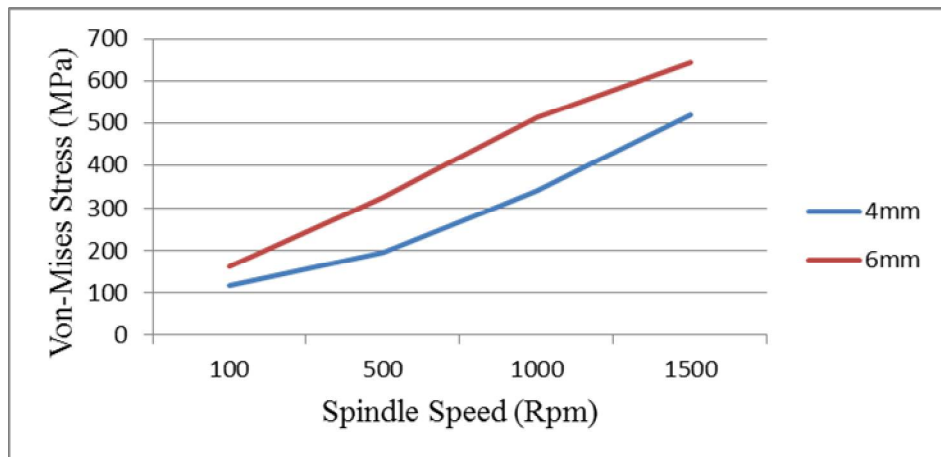

(c) For 118° point angle

Fig. 5. Spindle speed Vs Von-Mises stress

IV. CONCLUSION AND FUTURE CHALLENGES

- According to the literature survey, very less work on application of finite element method on machining of composites is done, particularly in drilling operation minimum work has been carried out.
- Research carried out in orthogonal cutting using finite element method is more compared to that of other machining operations.
- This paper gives a brief description of application of finite element method in drilling of CFRP composite.
- Influence of drilling parameters such as feed rate, spindle speed and point angle on delamination is explained.
- Von-mises stress was found to be increasing for higher feed rate and spindle speed.
- Drill diameter has also an influence on delamination and surface roughness of the material.

REFERENCES

- [1] Soutis, C., "Fibre reinforced composite in aircraft construction", *Progr Aerosp Sci*, vol. 41, pp. 143–51, 2005.
- [2] Gaitonde, V.N., Karnik, S.R., Rubio, J.C., Correia, A.E., Abrao, A.M., and Davim, J.P., "Analysis of parametric influence on delamination in high-speed drilling of carbon fiber reinforced plastic composites", *J Mater Process Technol*, vol. 203, pp. 431–9, 2008.
- [3] Hocheng, H., Tsao, C.C., "Effects of special drill bits on drilling-induced delamination of composite materials", *Int J Mach Tools Manuf*, vol. 46, pp. 1403–16, 2006.
- [4] Koplev, A., "Cutting of CFRP with single edge tools", *Proceed Adv Compos Mater*, pp. 1597-605, 1980.
- [5] Madhujit Mukhyopadhyay, "Mechanics of composite materials and structures", 2nd ed. Hyderabad: India; 2004.
- [6] Barbero, E.J., "Introduction to composite materials design", 2nd ed. London : New York; 2008.
- [7] Faraz, A., Biermann, D., Weinert, K., "Cutting edge rounding: an innovative tool wear criterion in drilling CFRP composite laminates", *Int J Mach Tools Manuf*, vol. 49, pp. 1185–96, 2009.
- [8] Durao, L.M.P., de Moura, MFSF., Marques, A.T., "Numerical simulation of the drilling process on carbon/epoxy composite laminates, *Compos Part-A: Appl Sci Manuf*, vol. 37, pp. 1325–33, 2006.
- [9] Friedrich, M.O., Burant, R.O., McGinty, M.J., "Cutting tools/drills: part 5-point styles and applications", *Manuf Eng*, vol. 83, pp. 29–31, 1979.
- [10] Khashaba, U.A., "Delamination in drilling GFR–thermoset composites", *Compos Struct*, vol. 63, pp. 313–27, 2004.
- [11] Lee, E.S., "Precision machining of glass fibre reinforced plastics with respect to tool characteristics", *Int J Adv Manuf Technol*, vol. 17, pp. 791–98, 2004.
- [12] Nor Khairusshima, M.K., Che Hassan, C.H., Jaharah, A.G., Nurul Amin A., "Tool wear and surface roughness on milling carbon fiber reinforced plastic using chilled air", *J Asian Sci Res*, vol. 2, pp. 593–98, 2012.
- [13] Suresh, K.R.N., Shin, K.W., Minyang, Yang., "Experimental study of surface integrity during end milling of Al/SiC particulate metal matrix composites", *J Mater Process Technol*, vol. 2, pp. 574–79, 2008.
- [14] Fernandes, M., Cook, C., "Drilling of carbon composites using a one shot drill bit, Part I-Five stage representation of drilling and factors affecting maximum force and torque", *Int J Mach Tools Manuf*, vol. 46, pp. 70–5, 2006.
- [15] Arola, D., Ramulu, M., "Orthogonal cutting of fiber reinforced composites- a finite element analysis", *Int J Mech Sci*, vol. 39, pp. 597–13, 1997.

International Journal of Innovative Research in Science, Engineering and Technology

(An ISO 3297: 2007 Certified Organization)

Vol. 5, Special Issue 9, May 2016

- [16] Shuji, U., Jon, W., Troy, M., "Finite element modeling of carbon fiber composite orthogonal cutting and drilling", *Procedia CIRP*, vol. 14, pp. 211–6, 2014.
- [17] Lau, W.S., Yue, T.M., Lee, T.C., Lee, W.B., "Unconventional machining of composite materials", *J Mater Process Technol*, vol. 48, pp. 199–05, 1995.
- [18] Lemma, E., Chen, L., Siores, E., Wang, J., "Study on cutting fiber-reinforced composites by using abrasive water-jet with cutting head oscillation", *Compos Struct*, vol. 57, pp. 297–03, 2002.
- [19] Shanmugam, D.K., Nguyen, T., Wang, J., "A study of delamination on graphite/epoxy composites in abrasive water jet machining", *Compos Part A: Appl Sci Manuf*, vol. 39, pp. 923–29, 2008.
- [20] Muller, F., Monaghan, J., "Non-conventional machining of particle reinforced metal matrix composite", *Int J Mach Tools Manuf*, vol. 40, pp. 1351–66, 2000.
- [21] Ho, K.H., Newman, S.T., "State of the art electrical discharge machining (EDM)", *Int J Mach Tools Manuf*, vol. 43, pp. 1287–300, 2003.
- [22] Stone, R., Krishnamurthy, K., "A neural network thrust force controller to minimize delamination during drilling of graphite/epoxy laminates", *J Mach Tools Manuf*, vol. 361, pp. 985-003, 1996.
- [23] Demeng, C., Ishan, S., Peidong, H., Ping, G., Kornel, E.F., "Machining of carbon fiber reinforced plastics/polymers: a literature review", *J Manuf Sci Eng*, vol. 136, pp. 034001-22, 2014.
- [24] Bhattacharya., Band Sorkhel, S.K., "Investigation for controlled electrochemical machining through response surface methodology based approach", *J Mater Process Technol*, vol. 86, pp. 200-07, 1999.
- [25] Tsao, C.C., Hocheng, H., Chen, Y.C., "Delamination reduction in drilling composite materials by active backup force", *CIRP Annals- Manuf Technol*, vol. 61, pp. 91–4, 2012.
- [26] Hamzeh, S., Mostafa, H., Masoud, F., "Experimental investigation of machining parameters on machinability of carbon fiber/epoxy composites", *Int J Eng Inn Technol*, vol. 2, pp. 30-6, 2012.
- [27] Hocheng, H., Tsao, C.C., "Effects of special drill bits on drilling-induced delamination of composite materials", *Int J Mach Tools Manuf*, vol. 46, pp. 1403–16, 2006.
- [28] Rakesh, P.K., Sharma, V., Singh, I., Kumar, D., "Delamination in fiber reinforced plastics: a finite element approach, [<http://www.SciRP.org/journal/eng>], 2011.
- [29] Singh, I., Bhatnagar, N., Viswanath, P., "Drilling of uni-directional glass fiber reinforced plastics: experimental and finite element study", *Mater Des*, vol. 29, pp. 546–53, 2011.
- [30] Ozden, I., Elaheh, G., "Numerical investigation of the effects of drill geometry on drilling induced delamination of carbon fiber reinforced composites", *Compos Struct*, vol. 105, pp. 126–33, 2013.