

Improving the Network Lifetime of MANETs Through Cooperative MAC Protocol Design

G.R.Naveen Karthick, G. Ramesh

Student, Dept. of Information Technology, K.L.N. College of Engineering and Technology, Madurai, Tamil Nadu,
India

Professor, Dept. of Information Technology, K.L.N. College of Engineering and Technology, Madurai, Tamil Nadu,
India

ABSTRACT: Wireless sensor networks (WSNs) consist of sensor nodes with sensing and communication capabilities. The important problem of applications of WSNs are energy conservation and increasing throughput. Cooperative Communication (CC), which utilizes nearby terminals to relay the overhearing information to achieve the diversity gains, has a great potential to improve the transmitting efficiency in wireless networks. In this paper, a novel cross-layer Distributed Energy-adaptive Location-based CMAC protocol has been proposed, namely DEL-CMAC, for Mobile Ad-hoc Networks (MANETs). The design objective of DEL-CMAC is to improve the performance of the MANETs in terms of network lifetime and energy efficiency. A practical energy consumption model is represented in this paper, which takes the energy consumption on both transceiver circuitry and transmit amplifier into account. A distributed utility-based best relay selection strategy is incorporated, which selects the best relay based on location information and residual energy. Furthermore, an innovative network allocation vector setting is provided to deal with the varying transmitting power of the source and relay terminals. We show that the proposed DEL-CMAC significantly prolongs the network lifetime under various circumstances even for high circuitry energy consumption cases by comprehensive simulation study.

KEYWORDS: Energy Conservation, WSNs, Network lifetime, cooperative communication, medium access control protocol, relay selection.

I. INTRODUCTION

Mobile Ad-hoc Network (MANET) is a self-configured network of mobile terminals connected by wireless links. Mobile terminals such as cellphones, portable gaming devices, personal digital assistants (PDAs) and tablets all have wireless networking capabilities. By participating in MANETs, these terminals may reach the Internet when they are not in the range of Wi-Fi access points or cellular base stations, or communicate with each other when no networking infrastructure is available. MANET can also be utilized in the disaster rescue and recovery described in [13]. One primary issue with continuous participation in MANETs is the network lifetime, because the aforementioned wireless terminals are battery powered, and energy is a scarce resource. Energy consumption in MANETs. The broadcast nature of the wireless medium (this so-called wireless broadcast advantage) is exploited in cooperative fashion. The wireless transmission between a pair of terminals can be received and processed at other terminals for performance gain, rather than be considered as an interference traditionally. It can provide gains in terms of the required transmitting power due to the spatial diversity achieved via user cooperation. However, if we take into account the extra processing and receiving energy consumption required for cooperation, CC is not always energy efficient compared to direct transmission. There is a tradeoff between the gains in transmitting power and the losses in extra energy consumption overhead. CC has been researched extensively from the information theoretic perspective [1], [2], [4], [5] and on the issues of relay selection [8], [11], [12]. Recently, the work on CC with regard to cross-layer design by considering cooperation in both physical layer and MAC layer attracts more and more attention. Without considering the MAC layer interactions and signaling

Improving the Network Lifetime of MANETs Through Cooperative MAC Protocol Design

overhead due to cooperation, the performance gain through physical layer cooperation may not improve end-to-end performance.

Cooperative MAC (CMAC) protocol considering the practical aspect of CC is vital. Liu et al. have proposed a CMAC protocols named CMAC [7] to exploit the multi-rate capability and aimed at mitigating the throughput bottleneck caused by the low data rate nodes, so that the throughput can be increased. With the similar goal, Zhu and Cao [8] have proposed a CMAC protocol for wireless ad hoc network. However, beneficial cooperation considering signaling overhead is not addressed in [7] and [8]. A busy-tone-based cross-layer CMAC protocol [9] has been designed to use busy tones to help avoiding collisions in the cooperative scenario at the cost on transmitting power, spectrum, and implementation complexity. A reactive network coding aware CMAC protocol has been proposed by Wang et al. [10], in which the relay node can forward the data for the source node, while delivering its own data simultaneously. But the network lifetime is not addressed in [10].

A distributed CMAC protocol [11] has been proposed to improve the lifetime of wireless sensor networks, but it is based on the assumption that every node can connect to the base station within one hop, which is impractical for most applications. A CMAC protocol for vehicular networks, particularly for gateway downloading scenarios, has been designed by Zhang et al. [12]. A drawback is that it can only be utilized in the scenario that all the vehicles are interested in the same information. Moreover, Moh and Yu [13] have designed a CMAC protocol named CD-MAC which lets the relay transmit simultaneously with the source using space-time coding technique. Shan et al. have explored a concept of cooperation region, whereby beneficial cooperative transmissions can be identified [11]. However, energy consumption is not evaluated for both of them.

The existing CMAC protocols mainly focus on the throughput enhancement while failing to investigate the energy efficiency or network lifetime. While the works on energy efficiency and network lifetime generally fixate on physical layer [6] or network layer [5]. Our work focuses on the MAC layer, and is distinguished from previous protocols by considering a practical energy model (i.e., energy consumption on both transceiver circuitry and transmit amplifier), with the goal to enhance energy efficiency and extend network lifetime. The tradeoff between the gains promised by cooperation and extra overhead is taken into consideration in the proposed protocol. In addition, in the previous works, very little attention has been paid to the impact brought by varying transmitting power in CC on the interference ranges, since constant transmitting power is generally used. The interference ranges alteration in both space and time will significantly affect the overall network performance. We also address the issue of effective coordination over multiple concurrent cooperative connections with dynamical transmitting power in this paper.

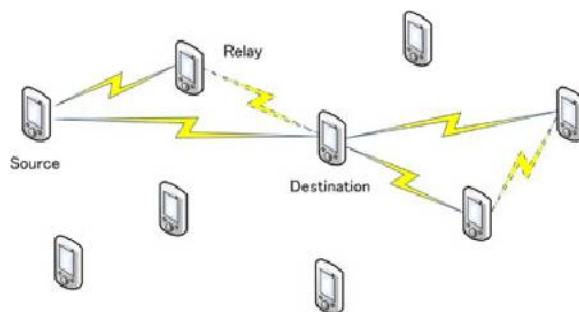

Fig.1 Multi hop MANET

In this paper, we propose a novel distributed energy adaptive location-based CMAC protocol, namely DELCMAC, for MANETs. DEL-CMAC is designed based on the IEEE 802.11 distributed coordination function (DCF), which is a widely used standard protocol for most of wireless networks. DEL-CMAC comprises a relay-involved handshaking process, a cross-layer power allocation scheme, a distributed utility-based best relay selection strategy, and an innovative Network Allocation Vector (NAV) setting. From the perspective of information theory, higher diversity gain can be obtained by increasing the number of relay terminals. From a MAC layer point of view, however, more relays lead to the enlarged interference ranges and additional control frame overheads. We employ single relay terminal in this paper to reduce the additional communication overhead. DEL-CMAC initiates the cooperation proactively, and utilizes the decode and forward (DF) protocol [1] in the physical layer. We summarize our contributions as follows.

II. SYSTEM MODEL

As shown in Fig. 1, a multi-hop MANET with randomly deployed mobile terminals is considered, where all terminals have the capability to relay. To come up with a reasonable system model, we assume that data connections among terminals are randomly generated and the routes are established by running Ad hoc On-demand

Improving the Network Lifetime of MANETs Through Cooperative MAC Protocol Design

DistanceVector (AODV) [9], which is a widely used conventional routing protocol for MANETs. There are two types of relay terminals in our network, i.e., routing relay terminals and cooperative relay terminals.

In the system model, AODV builds the route in a proactive manner by selecting the routing relay terminals firstly. When a route is established, DEL-CMAC initiates the cooperation in a hop-by-hop manner by selecting the cooperative relay terminals. In this paper, the source and destination terminals are referred to the terminals at MAC layer, and the relay terminals indicate the cooperative relay terminals. For convenience, we use term source, relay and destination in the remainder of the paper to denote the source terminal, relay terminal and destination terminal respectively.

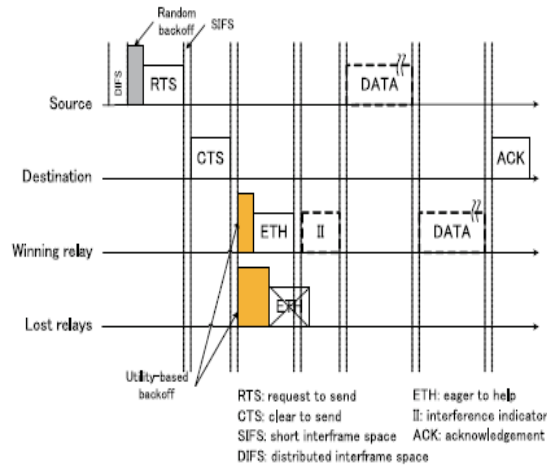

Fig.2: The frame exchanging process of DEL-CMAC.

introduces two new control frames to facilitate the cooperation, i.e., Eager-To-Help (ETH) and Interference-Indicator (II). The ETH frame is used for selecting the best relay in a distributed and lightweight manner, which is sent by the winning relay to inform the source, destination and lost relays. In this paper, the best relay is defined as the relay that has the maximum residual energy and requires the minimum transmitting power among the capable relay candidates. The II frame is utilized to reconfirm the interference range of allocated transmitting power at the winning relay, in order to enhance the spatial reuse. Among all the frames, RTS, CTS, ETH and ACK are transmitted by fixed power. And the transmitting power for the II frame and data packet are dynamically allocated. We denote the time durations for the transmission of RTS, CTS, ETH, ACK and II frames by T_{RTS} , T_{CTS} , T_{ETH} , T_{ACK} and T_{II} , respectively.

III. PROTOCOL DESCRIPTION

3.1 Operations at the Source

i. When a source wants to initiate the data transmission with payload length L bytes, it first senses the channel to check if it is idle. If the channel is idle for DIFS, the source chooses a random backoff timer between 0 and CW. When the backoff counter reaches zero, the source sends out a RTS to reserve the channel. Notice that different from DCF, the location information of the source is carried in the RTS, which is used in the optimal power allocation.

ii. If the source does not receive a CTS within $T_{RTS} \cup T_{CTS} \cup SIFS$, a retransmission process will be performed. Otherwise, in the case that FLAG_P of CTS is 0, the DEL-CMAC is reduced to DCF protocol, and we omit its operations in the following. In the case that FLAG_P is 1, the source waits for another $T_{maxBackoff} \cup T_{ETH} \cup SIFS$, where $T_{maxBackoff}$ is the maximum backoff time for the relay. If ETH is not received, which means that no capable relay exist, the source sends the data by direct transmission with data rate R .

iii. If both CTS and ETH are received, after waiting for $T_{II} \cup SIFS$, the source initiates a cooperative transmission with data rate $2R$ using the optimal transmitting power P_C which is piggybacked in the ETH. Notice that in order to maintain the end-to-end throughput, doubled data rate is employed in the cooperative transmission mode. We assume that the terminal can support two transmission rates by different coding and modulation schemes.

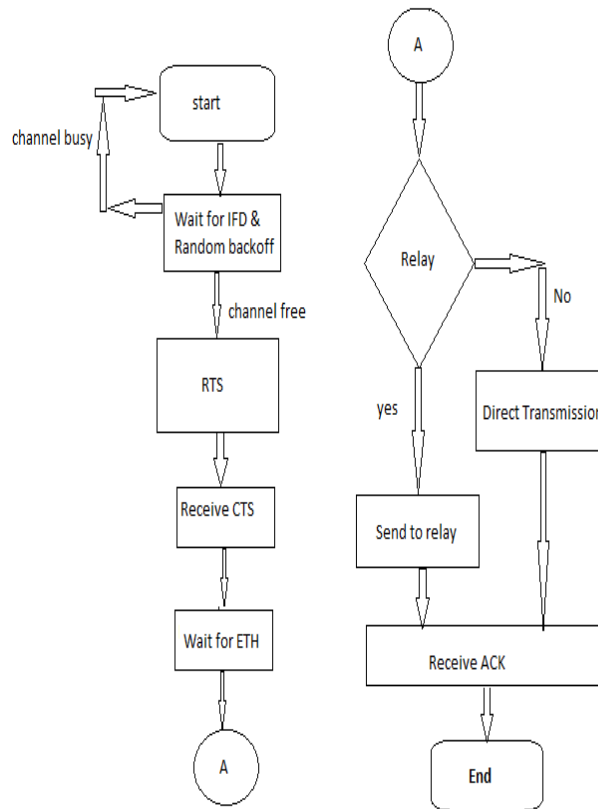

Fig.3: Flow chart of source node operation

3.2 Operations at the Destination

i. Upon receiving the RTS, the destination sends aCTS back after SIFS. The CTS contains the location information of the destination, the FLAG_P, and the transmitting power for the direct transmission PD (in the form of dB m, occupying 4 bytes), which is used for the possible relay contention.

ii. In the case that FLAG_P is 1, if the destination has not heard any ETH within $T_{maxBackoff}$ TCTS TETH SIFS, it assumes that the direct transmission will be performed and waits for the data packet from the source.

iii. Otherwise, the destination waits for the data packets from the source and winning relay. If the destination can decode the combined signals correctly, it sends back an ACK. Otherwise, it just lets the source timeout and retransmit.

3.3 Operations at the Relay

i. Any nodes other than source and destination will act as relay node. In this mode of operation relay nodes calculate source and destination vector distance from that node from RTS and CTS frame received powers.

ii. After calculating vector distance to both source and destination from relay nodes are summed up to get hopping distance. (source to relay + relay to destination).

iii. Residual battery power of relay nodes are calculated by own. Finally the relay which has both least hopping distance and more residual battery energy will send eager to help ETH frame very early. Other relays stop sending ETH after receiving one ETH. Thus best relay node selected.

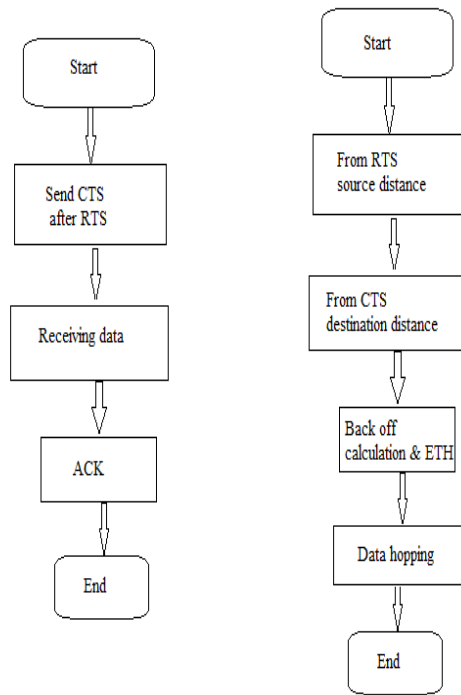
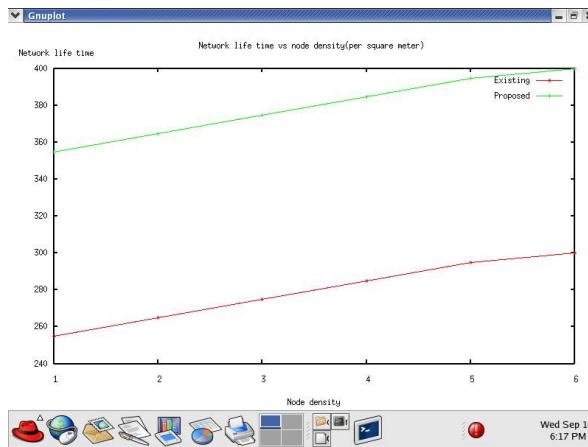
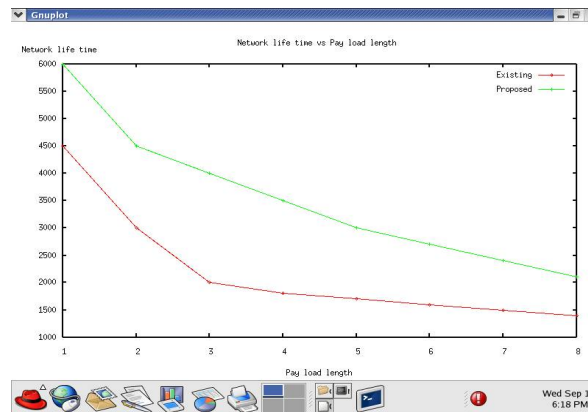

Fig.4:Flow chart for operation of destination and relay node.

IV.PERFORMANCE AND SIMULATION STUDY



Graph.1 Comparison between node density vs network lifetime



Graph.2 Comparison between payload length vs network lifetime

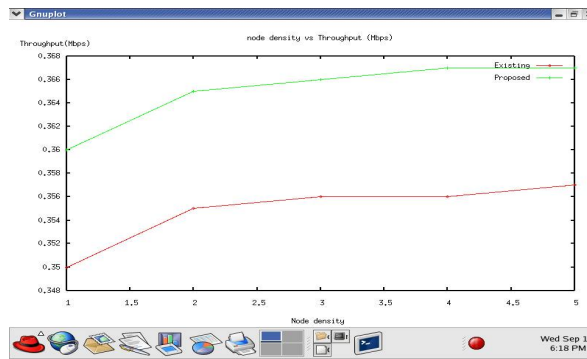

Graph.3 Comparison between Node density vs Throughput

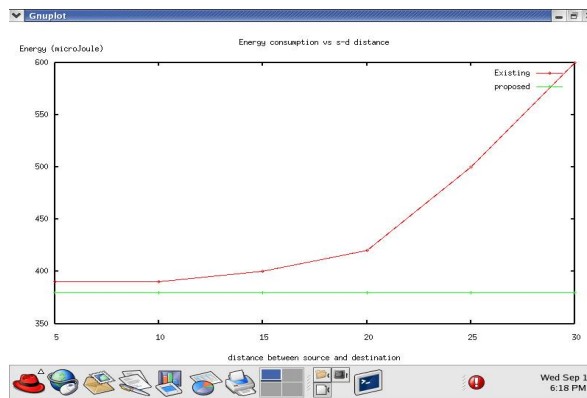

Graph.4 Comparison between energy consumption vs s-d distance

V.CONCLUSION

By introducing DEL-CMAC, both energy advantage and location advantage can be exploited thus the network lifetime is extended significantly. We have also proposed an effective relay selection strategy to choose the best relay terminal and a cross-layer optimal power allocation scheme to set the transmitting power. Moreover, we have enhanced the spatial reuse to minimize the interference among different connections by using novel NAV settings. We have demonstrated that DEL-CMAC can significantly prolong the network lifetime comparing with the IEEE 802.11 DCF and CMAC, at relatively low throughput and delay degradation cost. As a future work, we will investigate our DEL-CMAC for larger scale network size and with high mobility.

REFERENCES

- [1] J.N. Laneman, D.N.C. Tse, and G.W. Wornell, "Cooperative Diversity in Wireless Networks: Efficient Protocols and Outage Behaviour," IEEE Trans. Information Theory, vol. 50, no. 12, pp. 3062-3080, Dec. 2004.
- [2] A. Sendonaris, E. Erkip, and B. Aazhang, "User Cooperation Diversity-Part I: System Description," IEEE Trans. Comm., vol. 51, no. 11, pp. 1927-1938, Nov. 2003.
- [3] J.N. Laneman and G.W. Wornell, "Distributed Space-Time-Coded Protocols for Exploiting Cooperative Diversity in Wireless Networks," IEEE Trans. Information Theory, vol. 49, no. 10, pp. 2415-2425, Oct. 2003.
- [4] J. Wu, M. Cardei, F. Dai, and S. Yang, "Extended Dominating Set and Its Applications in Ad Hoc Networks Using Cooperative Communication," IEEE Trans. Parallel and Distributed Systems, vol. 17, no. 8, pp. 851-864, Aug. 2006.
- [5] Y. Zhu, M. Huang, S. Chen, and Y. Wang, "Energy-Efficient Topology Control in Cooperative Ad Hoc Networks," IEEE Trans. Parallel and Distributed Systems, vol. 23, no. 8, pp. 1480-1491, Aug. 2011.
- [6] S. Cui, A.J. Goldsmith, and A. Bahai, "Energy-Efficiency of MIMO and Cooperative MIMO in Sensor Networks," IEEE J. Selected Areas in Comm., vol. 22, no. 6, pp. 1089-1098, Aug. 2004.
- [7] P. Liu, Z. Tao, S. Narayanan, T. Korakis, and S.S. Panwar, "CoopMAC: A Cooperative MAC for Wireless LANs," IEEE J. Selected Areas in Comm., vol. 25, no. 2, pp. 340-354, Feb. 2007.
- [8] H. Zhu and G. Cao, "rDCF: A Relay-Enabled Medium Access Control Protocol for Wireless Ad Hoc Networks," IEEE Trans. Mobile Computing, vol. 5, no. 9, pp. 1201-1214, Sept. 2006.
- [9] H. Shan, P. Wang, W. Zhuang, and Z. Wang, "Cross-Layer Cooperative Triple Busy Tone Multiple Access for Wireless Networks," Proc. IEEE GLOBECOM, pp. 1-5, Dec. 2008.
- [10] X. Wang, J. Li, and M. Guizani, "NCAC-MAC: Network Coding Aware Cooperative Medium Access Control for Wireless Networks," Proc. IEEE Wireless Comm. and Networking Conf. (WCNC '12), pp. 1646-1651, Apr. 2012.
- [11] C. Zhai, J. Liu, L. Zheng, and H. Xu, "Lifetime Maximization via a New Cooperative MAC Protocol in Wireless Sensor Networks," Proc. IEEE GLOBECOM, pp. 1-6, Dec. 2009.
- [12] J. Zhang, Q. Zhang, and W. Jia, "VC-MAC: A Cooperative MAC Protocol in Vehicular Networks," IEEE Trans. Vehicular Technology, vol. 58, no. 3, pp. 1561-1571, Mar. 2009.
- [13] S. Moh and C. Yu, "A Cooperative Diversity-Based Robust MAC Protocol in Wireless Ad Hoc Networks," IEEE Trans. Parallel and Distributed Systems, vol. 22, no. 3, pp. 353-363, Mar. 2011.