

# **Fuzzy Linked Adaptive P&O Technique with Stability Analysis of Photovoltaic System**

M. Anbarasan, M. Muthuvinayagam

PG Student M.E (Control Systems), Department of EEE, Mahendra Engineering College, Namakkal, Tamilnadu, India

Professor, Department of EEE, Mahendra Engineering College, Namakkal, Tamilnadu, India

**ABSTRACT:** This paper presents an adaptive perturb and observe (P&O)-fuzzy control maximum power point tracking (MPPT) for photovoltaic (PV) boost dc–dc converter. P&O is known as a very simple MPPT algorithm and used widely. Fuzzy logic is also simple to be developed and provides fast response. The proposed technique combines both of their advantages. It should improve MPPT performance especially with existing of noise. For evaluation and comparison analysis, conventional P&O and fuzzy logic control algorithms have been developed too. All the algorithms were simulated in MATLAB-Simulink, respectively, together with PV module of Kyocera KD210GH-2PU connected to PV boost dc–dc converter. For hardware implementation, the proposed adaptive P&O-fuzzy control MPPT was programmed in TMS320F28335 digital signal processing board. The other two conventional MPPT methods were also programmed for comparison purpose. Performance assessment covers overshoot, time response, maximum power ratio, oscillation and stability as described further in this study. From the results and analysis, the adaptive P&O-fuzzy control MPPT shows the best performance with fast time response, less overshoot and more stable operation. It has high maximum power ratio as compared to the other two conventional MPPT algorithms especially with existing of noise in the system at low irradiance.

**KEYWORDS:** Photovoltaic (PV), boost dc–dc converter, maximum power point tracking (MPPT), Fuzzy logic control,

## **I. INTRODUCTION**

Energy is indispensable to human life. Energy is not only a measurement for economic and social improvement but also a fundamental human necessity. To solve energy problems such as energy importation, minimization of environmental pollution, global warming, increasing cost of energy, and energy inefficiency is the important crisis in our day to day life. Photovoltaic (PV) system has gained wide popularity in the past decade as one of the renewable energy sources due to the possibility of depletion of conventional energy sources and its high cost as well as its negative effects on the environment. One essential fundamental of all PV is the efficacy of its maximum power point tracking. Also, solar photovoltaic (PV) is envisaged to be a popular source of renewable energy due to several advantages, notably low operational cost, almost maintenance free and environmentally friendly. Despite the high cost of solar modules, PV power generation systems, in particular the grid-connected type, have been commercialized in many countries because of its potential long term benefits Energy is indispensable to human life. Energy is not only a measurement for economic and social improvement but also a fundamental human necessity.

To solve energy problems such as energy importation, minimization of environmental pollution, global warming, increasing cost of energy, and energy inefficiency is the important crisis in our day to day life. Photovoltaic (PV) system has gained wide popularity in the past decade as one of the renewable energy sources due to the possibility of depletion of conventional energy sources and its high cost as well as its negative effects on the environment. One essential fundamental of all PV is the efficacy of its maximum power point tracking. Also, solar photovoltaic (PV) is envisaged to be a popular source of renewable energy due to several advantages, notably low operational cost, almost maintenance free and environmentally friendly. Despite the high cost of solar modules, PV power generation systems, in particular the grid-connected type, have been commercialized in many countries because of its potential long term benefits

# International Journal of Innovative Research in Science, Engineering and Technology

(An ISO 3297: 2007 Certified Organization)

Vol. 5, Issue 1, January 2016

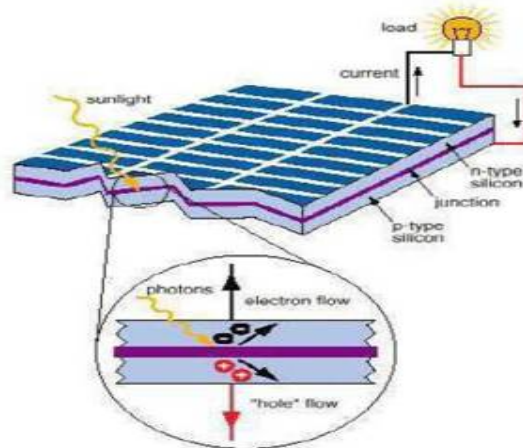

**Figure: 1** Basic structure of PV cell

Poor tracking, not intelligent enough and less efficient during rapid change of the irradiance because it moves away from the real maximum power point (MPP). Inability to verify whether the higher new output power value is because of the new irradiation amount or the new duty cycle value

Continuous oscillations around the optimal operating point make the average power level is deviated from the MPP especially at low irradiance. It goes back and forth around the MPP and unable to stick exactly. Slow time response. Another possible significant drawback of this algorithm is its inability to perform well with existing of noise. In such PV system, noise factor exists and must seriously be considered not only because of non-linearity of PV source, but may come from the embedded controller, voltage and current measurements. The noises from both measurements have significant effect on the decisions made by the MPPT algorithm. In specific case, for example, at the MPP, the algorithm is expected to make an equal number of decisions for incrementing and decrementing the reference, leaving the operating point constant on average. With noisy voltage and the current measurements, some of the decisions made by the algorithm.

## II. DC-DC BOOST CONVERTER

PV dc-dc boost converter PV systems typically employ a dc-dc or dc-ac converter, with or without battery charging capabilities, which make use of MPPT. Dc-dc converter can be used as switching-mode regulator to convert a dc voltage, normally unregulated, to a regulated dc output voltage. The regulation is normally achieved by pulse-width modulation (PWM) technique and the switching device is normally MOSFET or IGBT. Boost dc-dc converter's function is to step up dc voltage. Maximum power is reached when the MPPT algorithm changes and adjusts the PWM's duty cycle of the boost dc-dc converter. The value of inductor is 120  $\mu$ H and the capacitor is about 470  $\mu$ F. For the load, resistor is used with value of 50  $\Omega$ .

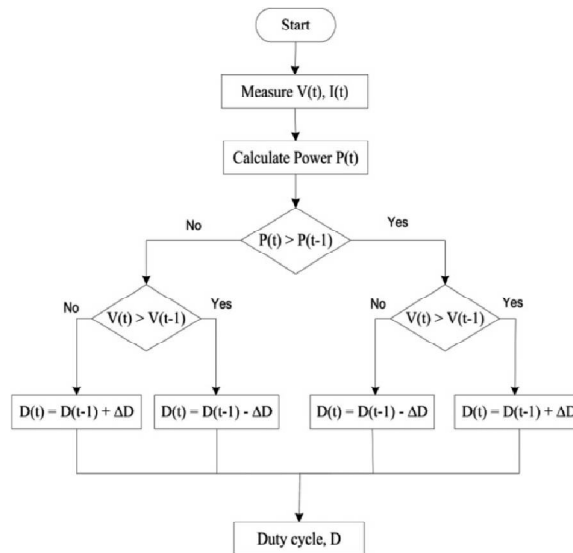

**Figure:2** P&O Algorithm With Direct Duty Cycle

### III. MAXIMUM POWER POINT TRACKING

#### 3.1 PERTURB AND OBSERVE

The conventional and popular MPPT method is P&O algorithm. This algorithm works by using the method of perturbation on the desired maximum point. Two types of P&O are by using direct duty cycle to produce output (also known as hill climbing), or by using voltage reference. The advantage of using direct duty cycle is it can avoid using proportional-integral algorithm to control overshoot and steady-state error of the output. However, its disadvantage is hard to tune to obtain the desired duty cycle. Fig. 2 shows flowchart of classic P&O algorithm with duty cycle method. When PV power and voltage are increasing, a perturbation will increase a step size  $\Delta D$  to be added with the duty cycle  $D$ , in order to generate next cycle of perturbation and to force the operating point moving towards the MPP. If the PV power decreases and PV voltage increases, the P&O will work vice versa. The inputs of the P&O algorithm are current and voltage of the PV. Previous works evaluated this algorithm in steady-state operation. It was noticed some oscillations occurred around the MPP which caused power losses.

Lower MPPT performance including achievement of MPP ratio for this algorithm at the steady-state operation has significantly been reported and discussed. Among reported MPP ratio were around 80%, 85.99% and up to 90%. However, the worst MPP ratio was reported in, which was about 68% only. In the range of MPP ratio was reported rather than specific value, which was around 81– 85% only. Besides assessment in the steady-state operation, MPPT performance can be evaluated under dynamic approach with continuous varying irradiance intensities.

The dynamic approach has been regarded as a good performance indicator for MPPT, as highlighted in European Standard EN 50530, which was released on April 2010. In this standard, the irradiance profile for evaluating dynamic MPPT performance is presented. Further previous works on P&O algorithm in dynamic operation reported the MPP ratio or efficiency were above 98 and 99.5%, respectively, with important highlight that both of them were operated at high irradiation condition. Meanwhile, there were some research works that tried to improve the P&O algorithm. In both peak current control and instantaneous value of power were used to calculate the direction of next cycle. These works contributed to increasing of the speed response of the system and reducing the amplitude of power oscillations around the MPP. Another work in proposed a novel MPPT control algorithm for a half bridge inverter with a control unit consisting of a multistage buck–boost converter. It allowed each of the PV modules to generate its maximum power by simply detecting only the total output power of the PV system. In the three-point weight comparison for P&O method was proposed to track the MPP under rapid changes of irradiance. Besides that, sampling rate may contribute to better performance of MPPT, and thus, optimization of sampling rate was done to improve time response and efficiency of the algorithm to make appropriate decision.

# International Journal of Innovative Research in Science, Engineering and Technology

(An ISO 3297: 2007 Certified Organization)

Vol. 5, Issue 1, Januray 2016

## 3.2 FUZZY LOGIC CONTROL

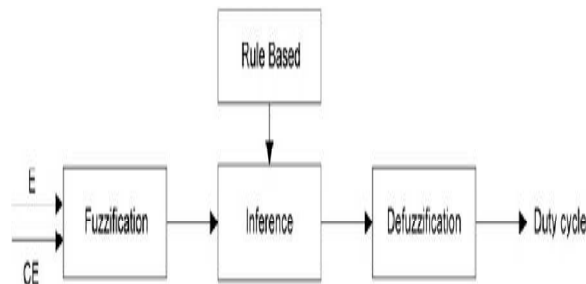
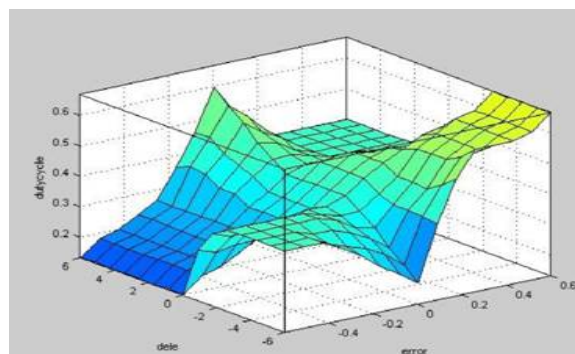

**Figure: 3** Block diagram of conventional FLC MPPT algorithm

Application of artificial intelligence is the new trend of research works in MPPT. Typical or conventional FLC for MPPT uses two inputs such as error  $E$  and change in error  $CE$  at sample time  $k$ , which are defined by (1) and (2), while the output of FLC is the duty cycle  $D$ . Equation FLC is divided into four categories, which include fuzzification, fuzzy inference, and rule-base and defuzzification as shown in Fig. 3. During fuzzification, the numerical input variables are converted into linguistic variables based on the membership functions.

Various fuzzy levels could be used for input and output variables. In operation of MPPT control, after  $E$  and  $CE$  are calculated, these inputs are converted into linguistic variables and then the output  $D$  is generated by looking up in a rule-base table. The FLC tracks the MPP based on master rule of 'If  $X$  and  $Y$ , Then  $Z$ '. To determine the output of the fuzzy logic, the fuzzy inference is used. There are many methods for inference. Other methods include compositional rule of inference, generalized Modus Ponens and Surgeon inference method. Usually, weights are added to the rules to improve reasoning accuracy and to reduce undesirable consequent. The fuzzy output is converted back to numerical variable from linguistic variable during defuzzification. The most common method used for this defuzzification is the centroid of area (COA) since it has good averaging properties and it produces more accurate results. Other defuzzification methods include bisector and middle of maxima.

Evaluation of MPP ratio was also carried in some works related to this MPPT algorithm. In the MPP ratio for this work was reported about 90–96% of the maximum power. In another work, the MPP ratio of FLC was higher around 2.53% from classical P&O MPPT algorithm. FLC MPPT algorithm also caused power losses around 6.28% from the overall maximum power. Besides that, there were some previous research works on improving the conventional FLC for MPPT. Among reported works were related to additional of more variables in the membership function, use of three or more inputs to the fuzzy logic, employing of fuzzy cognitive networks to enhance the MPPT performance and use of a single input of FLC by applying the 'signed distance method' to change conventional inputs such as error and change of error



**Figure: 4** Surface viewer of fuzzy logic controller

## International Journal of Innovative Research in Science, Engineering and Technology

(An ISO 3297: 2007 Certified Organization)

Vol. 5, Issue 1, Januray 2016

### 3.3 ADAPTIVE P&O-FLC

This method uses existing inputs of P&O algorithm such as differential power and differential voltage. The proposed change in this algorithm is to replace comparing and switching methods with fuzzy logic approach, as shown in Five proposed fuzzy sets for input/output variables are N (negative), ZE (zero), PS (positive small), P (positive) and PB (positive big), its membership functions for input of difference between the current power and the previous power  $\Delta P$ , input of difference between the current voltage and the previous voltage  $\Delta V$  and output of difference between the current duty cycle and the previous duty cycle  $\Delta D$ . After  $\Delta P$  and  $\Delta V$  are calculated, they are converted into linguistic variables and then the output  $\Delta D$  is generated, which consists of 25 rules. This algorithm uses Mamdani fuzzy inference system to determine the output. For the defuzzification, the common COA is used. In its operation, when  $\Delta P$  and  $\Delta V$  are either positive or negative values, the FLC will decide the best and accurate value of  $\Delta D$ . Therefore  $\Delta D$  will be changed according to the condition of  $\Delta P$  and  $\Delta V$  at certain time where measurement process is done. It will obey the membership function designed in the proposed FLC.

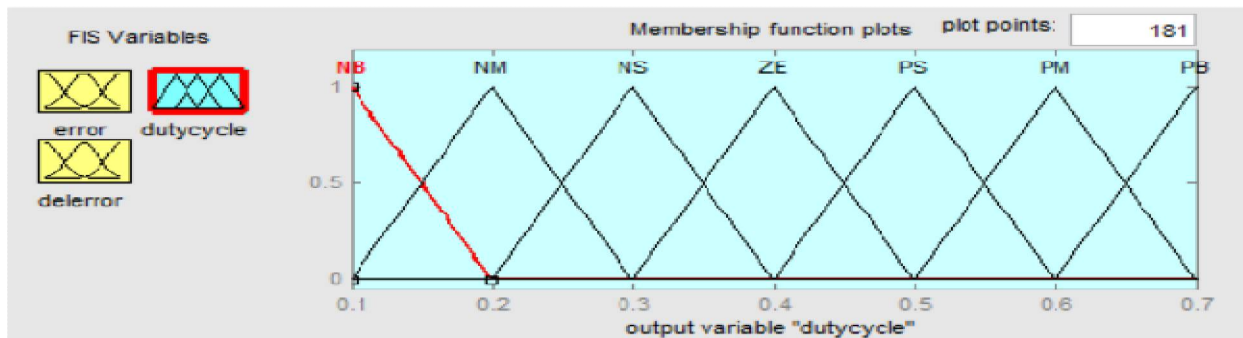

Figure: 5 Error input of fuzzy logic controller

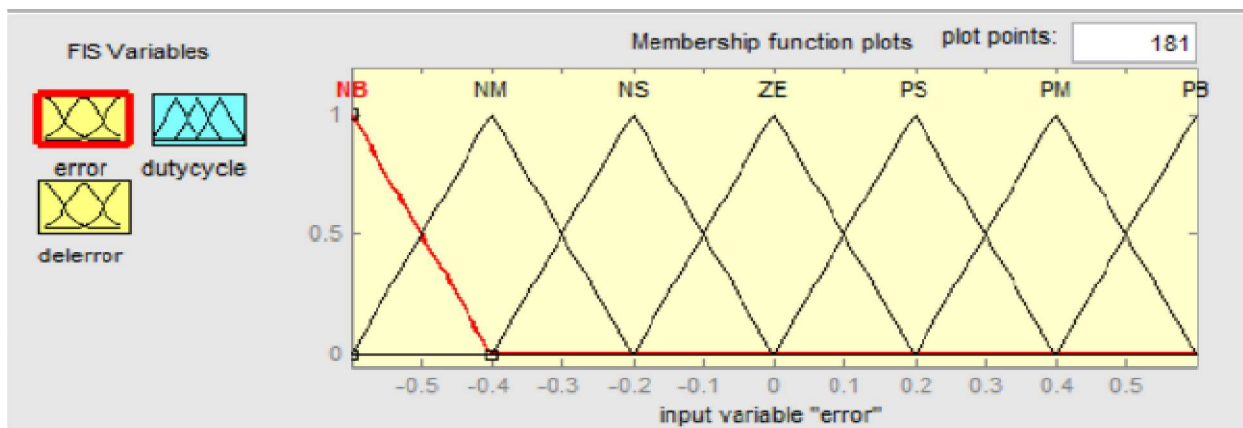

Figure: 6 Change of Error input of fuzzy logic controller

## IV. SIMULATION RESULT

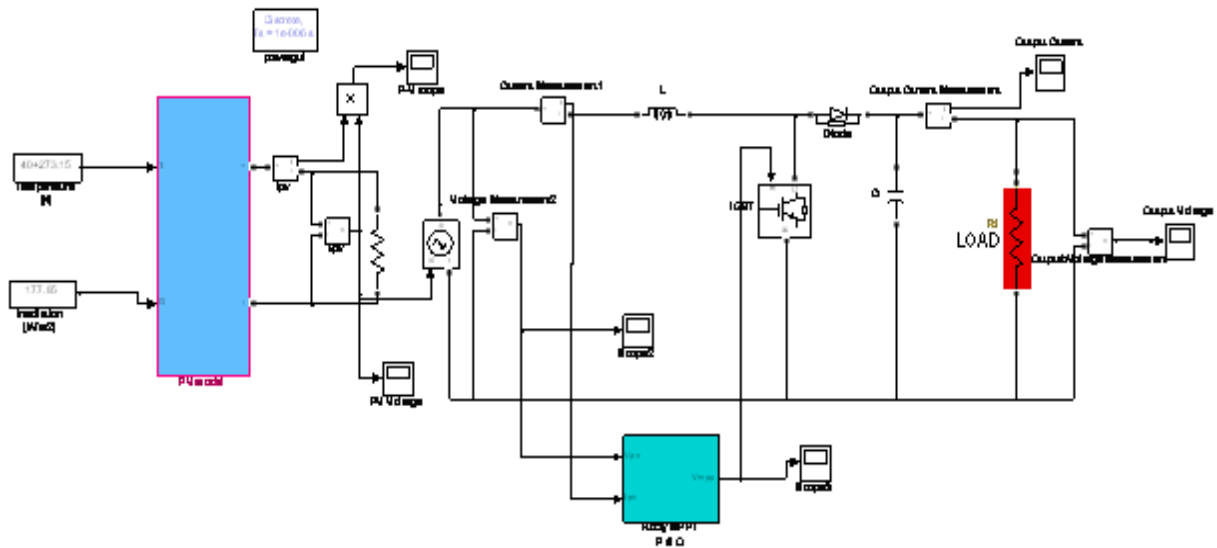

Figure: 7 Simulation Diagram of Complete PV Schematic

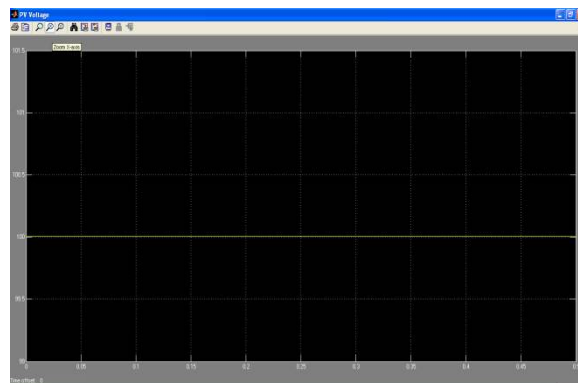

Figure: 7 Output Result of Complete PV Output Voltage

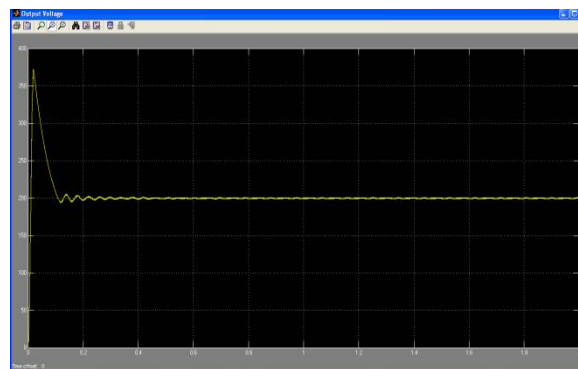

Figure: 8 Output Result of Complete DC-DC Output Voltage

# International Journal of Innovative Research in Science, Engineering and Technology

(An ISO 3297: 2007 Certified Organization)

Vol. 5, Issue 1, January 2016

## V. CONCLUSION

In this work, Mathematical modeling of photovoltaic system is designed and MPPT technique such as fuzzy controls and adaptive controls and Fuzzy linked Adaptive particle swarm optimization based technique for the maximum power point tracking of photovoltaic systems is introduced with the consideration of factors such as complexity, cost, range of effectiveness and convergence speed. Appropriate tracking is ensured when irradiation and temperature changes.

The entire energy conversion system has been designed in MATLAB-SIMULINK environment. Simulation model and simulation results in reference to model confirm the performance of the proposed control technique. The open circuit P-V and I-V curves are obtained from the simulation of the PV array infers that it is dependent on the irradiation level and temperature. Various values of the voltage and current obtained are plotted in the open circuit I-V curves of the PV array at different isolation levels. The voltage and current values lie on the curve showing that the coupling of the PV array with the boost converter is proper.

The output power obtained from fuzzy logic based MPP technique ensures tracking of maximum power without any switching ripples and steady state oscillations but with less accuracy and less efficiency and the convergence speed is fast. The output power obtained from adaptive particle swarm optimization based MPP technique ensures tracking of maximum power with more accuracy and more efficiency and convergence speed of APSO is slow. Fuzzy linked APSO based MPPT is designed and ensures tracking of accuracy with slow convergence speed, more accuracy and more efficiency, less switching ripples and less steady state oscillations. On the other hand, the output obtained through Fuzzy linked APSO based MPPT has to be fine-tuned such that the switching ripples and steady state oscillations are rejected.

## REFERENCES

1. Ishaque, K., Salam, Z.: 'A review of maximum power point tracking techniques of PV system for uniform insulation and partial shading condition', *Renew. Sustain. Energy Rev.*, 2013, 19, pp. 475–488
2. Younis, M.A., Khatib, T., Najeeb, M., Mohd Ariffin, A.: 'An improved maximum power point tracking controller for PV systems using artificial neural network', *Prz. Elektro tech. (Electr. Rev.)*, 2012, 3, pp. 116–121
3. Algazar, M.M., AL-monier, H., Abd EL-halim, H., El Kotb Salem, M.E.: 'Maximum power point tracking using fuzzy logic control', *Electr. Power Energy Syst.*, 2012, 39, pp. 21–28
4. Ramaprabha, R., Balaji, M., Mathur, B.L.: 'Maximum power point tracking of partially shaded solar PV system using modified Fibonacci search method with fuzzy controller', *Electr. Power Energy Syst.*, 2012, 43, pp. 754–765
5. Chao, P.C.P., Chen, W.D., Chang, C.K.: 'Maximum power tracking of a generic photovoltaic system via a fuzzy controller and a two-stage DC–DC converter', *Micro syst. Technol.*, 2012, 18, pp. 1267–1281
6. Al Nabulsi, A., Dhaouadi, R.: 'Fuzzy logic controller based perturb and observe maximum power point tracking'. *Int. Conf. on Renewable Energies and Power Quality*, 2012, pp. 1–6
7. Harjai, A., Bhardwaj, A., Sandhibigraha, M.: 'Study of maximum power point tracking (MPPT) techniques in a solar photovoltaic array'. Thesis, Department of Electrical Engineering National Institute of Technology, Rourkela, Orissa, 2011, pp. 43–49
8. Ngan, M.S., Tan, C.W.: 'A study of maximum power point tracking algorithms for stand-alone photovoltaic systems'. *IEEE Applied Power Electronics Colloquium (IAPEC)*, 2011, pp. 22–27
9. Bennett, T., Zilouchian, A., Messenger, R.: 'Photovoltaic model and converter topology considerations for MPPT purposes', *Sol. Energy*, 2012, 86, pp. 2029–2040
10. Houssamo, I., Locment, F., Sechilariu, M.: 'Experimental analysis of impact of MPPT methods on energy efficiency for photovoltaic power systems', *Int. J. Electr. Power Energy Syst.*, 2013, 46, pp. 98–107
11. Yu, B., Yu, G., Kim, Y.: 'Design and experimental results of improved dynamic MPPT performance by EN5053'. *IEEE 33rd Int. Telecommunications Energy Conf. (INTELEC)*, 2011, pp. 1–4
12. Ammasai Gounden, N., Peter, S.A., Nallandula, H., Krithiga, S.: 'Fuzzylogic controller with MPPT using line-commutated inverter for three-phase grid-connected photovoltaic systems', *Renew. Energy*, 2009, 34, pp. 909–915.