

Effects of Dimensional Tolerances on Ogive Shaped Casing

Chaitanya Jadhav¹, Priyanka Jadhav², Sayali Khot³, Deepak Kulkarni⁴, Prof. P.N.Deshmukh⁵

Bachelor of Engineering, Department of Mechanical Engineering, R.M.D. Sinhgad School of Engineering, Pune, Maharashtra, India^{1,2,3,4}

Professor, Department of Mechanical Engineering, R.M.D. Sinhgad School of Engineering, Pune, Maharashtra, India⁵

ABSTRACT: Ogive shape warhead, used in missiles by defence organizations since 1951 is mostly used for wars. Ogive shape warhead being cylindrical in shape can carry a large number of fragments and can send explosives in maximum directions hence is most widely used. This is a explosive type warhead.

Ogive shape warhead being cylindrical, got manufacturing defects that need to be work on. Due to its ogive shape, explosives carried by them are not exploded in respective directions. This defect is arising due to improper tolerances and dimensioning of the warhead.

As the shape of the casing is ogive and fragments being cubical they are in need of proper tolerances for explosion in desired direction. To give respective tolerances, inclination of fragments, capacity of casing are to be found out, simultaneously left side radius and right side radius respectively.

Once both the radii, inclination of fragments and capacity are known tolerances can be given in proper manner. For finding out these parameters programming is carried out in Matlab language. Once they are known tolerances can be given.

KEYWORDS: Warhead, ogive shaped profile, tolerances, fragments.

I. INTRODUCTION

The basic function of any weapon or a warhead is to deliver the required amount of destructive force. Different targets demand for different warheads or weapons. Depending on this, four basic warheads are introduced under Integrated Guided Missile Development Programme. The pre-fragmented warhead is generally used for soft targets, submunition warhead is generally effective against the AFVs (Armoured fighting vehicle), submunition incendiary is mostly effective against the inflammable targets, the Runway Denial Penetrating Submunition is used against the hard targets like runway and industrial complexes. Tolerances are given to these warheads for their proper destruction. It is important to understand what tolerance is. ASME Y14.5 defines it as “the total amount a dimension is permitted to vary”.



(a)

Fig. 1 missile (a)ogive shaped warheads used in missiles

International Journal of Innovative Research in Science, Engineering and Technology

(An ISO 3297: 2007 Certified Organization)

Vol. 5, Issue 5, May 2016

II. RELATED WORK

1. Author Name: George Kaisarlis, Christofer Provatidis
Title Name: 'Cad-Based And Geometrical Tolerancing Implementation By The Use Of Virtual Gauges: A Case Study'.
Due to the inevitable uncertainties that are present in any production process, all manufactured components exhibit a variety of imperfections. Dimensional and geometric tolerances are therefore assigned as allowable limits of these imperfections. The objective of tolerance assignment on mechanical components is to safeguard that the final product, on which they will fit, can be assembled and will meet the necessary functional and other geometric requirements. Moreover, the control of unavoidable deviations from nominal geometric and dimensional requirements during the manufacture of mechanical components also safeguard their interchangeability. The above objectives are currently implemented in mechanical engineering design through the series of national and international Geometric Dimensioning and Tolerancing (GD&T) standards.
2. Title Name: Indian Standard, General Tolerances (Third Revision)
This part of ISO 2768 is intended to simplify drawing indications and it specifies general tolerances for linear and angular dimensions. When selecting the tolerances class, the respective customary workshop accuracy has to be taken into consideration. If smaller tolerances are required or larger tolerances are permissible and more economical for any individual feature, such tolerances should be indicated adjacent to the relevant nominal dimensions.
3. Title Name: General Tolerancing on Technical Drawings
This international standard gives the principles of symbolization and indication on technical drawings of tolerances of form, orientation, location and run-out, and establishes the appropriate geometrical definitions. Hence, the term "geometrical tolerances" will be used in this document as synonymous with these groups of tolerances. A geometrical tolerance applied to a feature defines the tolerance zone within which the feature (surface, axis or median plane) is to be contained.
4. Title Name: Technical Drawings- Geometrical Tolerancing (First Revision)
The assembly of parts depends upon the relationship between the actual size and actual geometrical deviation of the features been fitted together, such as the bolt holes in two flanges and bolts securing them. This International Standard defines and describes the maximum material principle and specifies its application.

III. OBJECTIVE

To minimise the errors caused due to the ogive shaped casing, we need to measure the capacity of warhead casing to accommodate the explosives into it. Hence, we need to calculate the left side radius and right side radius of warhead casing also we need to calculate the number of fragments fitting on the outer periphery of ogive shaped casing, as these fragments are cubical.

Ideally these cubical fragments should fit close to each other on the outer periphery of the casing but, practically it is not possible due to ogive shape of casing. Hence, by giving effective and proper tolerances we need to make the projections of fragments in desired direction.

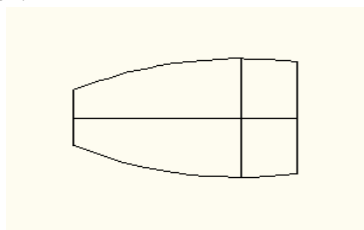

(b)

Fig.2. Ogive shaped casing (b) This is the basic design of ogive shape used as warhead. Volume carrying capacity of this shape is more than the cylindrical shaped warhead.

International Journal of Innovative Research in Science, Engineering and Technology

(An ISO 3297: 2007 Certified Organization)

Vol. 5, Issue 5, May 2016

IV. CONCEPT

The basic function of any weapon is to deliver a destructive force on an enemy target. Targets of today include military bases, factories, bridges, ships, tanks, missile launching sites, artillery emplacements, fortifications, and troop concentrations. NEach target defines its own problem and it can be solved by unique methods respectively.

A warhead of ogive shape is selected. N Basically it faces problem for projection of its fragments.This problem is solved by giving tolerances to the parameters of the geometry.Tolerances are of various types.The one used for our solution is Dimensional tolerances.Tolerances are given to the respective dimensions for appropriate projection of fragments.

An ogive shaped geometry is selected with 400mm length,300mm maximum diameter,300 mm left side distance,100mm right side distance and radius of ogive as 600mm.Using these basic parameters,other dimensions such as left side radius,right side radius, angles of projection and other parameters are found out.

A particular program is designed in Matlab language for finding out other parameters like arc length,angles of projection, explosivemass,casingmass,fragment mass etc. This program is run many a times for basic dimensions and then by giving tolerances to respective dimensions in various categories such as very coarse, coarse, medium and fine.

All the obtained basic dimensions and dimensions with tolerances are noted down and percent error is found out.Later,respective graphs are plotted for results. Designing is carried out in Autocad software for 2D view and in Catia software for 3D view.This is also done to cross verify the values obtained through program in Matlab software.

A sincere effort is being carried out to solve the problem of projection of fragments upto some extent.

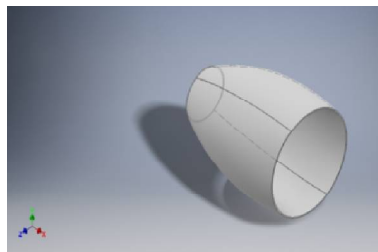

(c)

Fig.3.Design in Catia (c) shows 3D modeling of Ogive shape warhead.

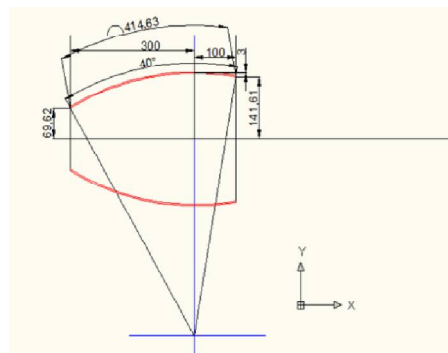

(d)

Fig.4.Design in Autocad (d) shows 2D modeling of Ogive shape warhead.

International Journal of Innovative Research in Science, Engineering and Technology

(An ISO 3297: 2007 Certified Organization)

Vol. 5, Issue 5, May 2016

V. RESULTS AND DISCUSSION

Percent error when tolerances are given to ogive radius only:

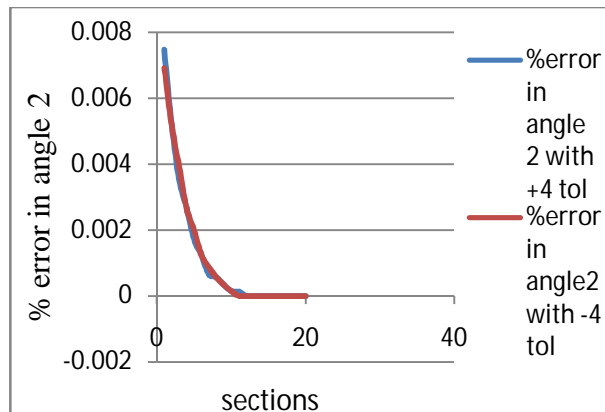

(e)

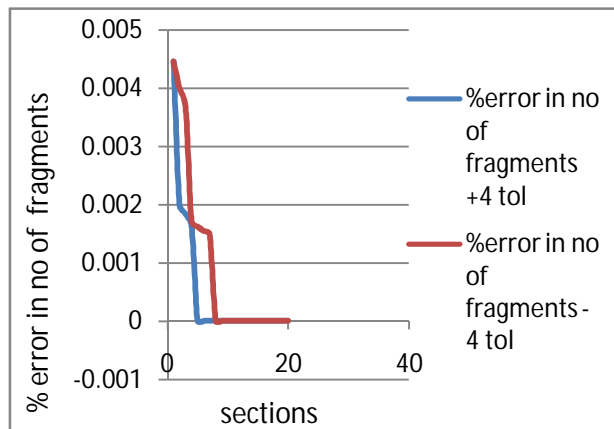

(f)

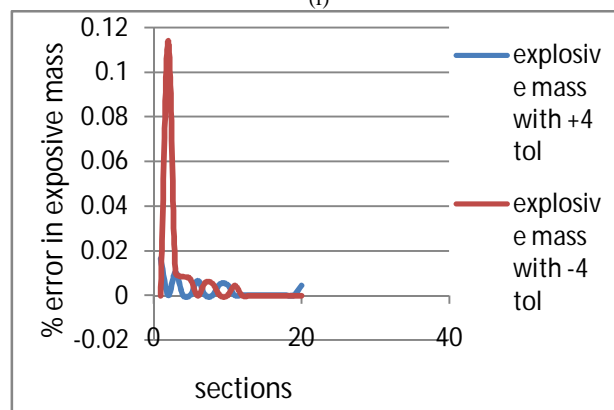

(g)

Fig.5. Graphs describing percent error when tolerances are given to ogive radius only: (e)graph representing percent error in angle2 (f) graph representing percent error in number of fragments (g) graph representing percent error in explosive mass

International Journal of Innovative Research in Science, Engineering and Technology

(An ISO 3297: 2007 Certified Organization)

Vol. 5, Issue 5, May 2016

From the Graph 5: (e),(f),(g) we can see that

- Error in angle 2 firstly decreases till a certain limit. The main reason for this is the curve.
- Due to tolerances the distance between the arbitrary point and the curve increases. The same is applicable when -4 tolerances is provided. This difference or error occurs due to the ogive shaped casing.
- This error would be minimum or negligible if the casing would have been cylindrical. Due to the ogive shape the curve tends to increase firstly then after a certain point error diminishes. Similarly, when -4 tolerances is applied the value of angle decreases upto a certain limit and then the error diminishes.

Graphs describing percent error when tolerances are given to ogive radius, left side radius and right side radius:

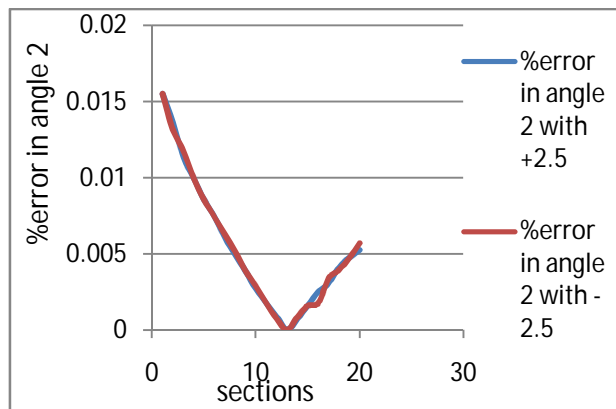

(h)

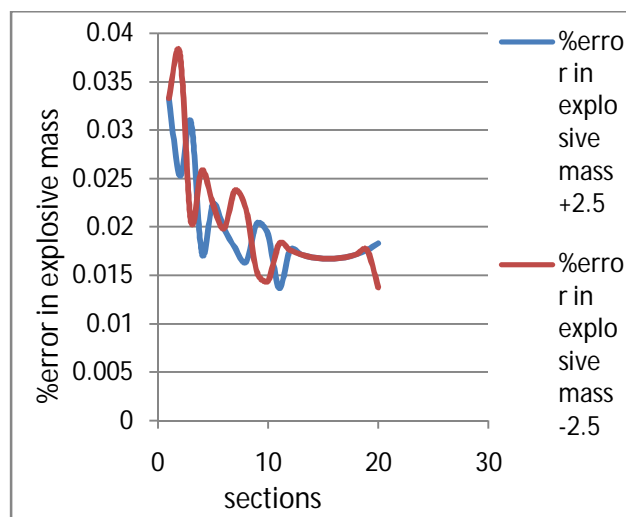

(i)

International Journal of Innovative Research in Science, Engineering and Technology

(An ISO 3297: 2007 Certified Organization)

Vol. 5, Issue 5, May 2016

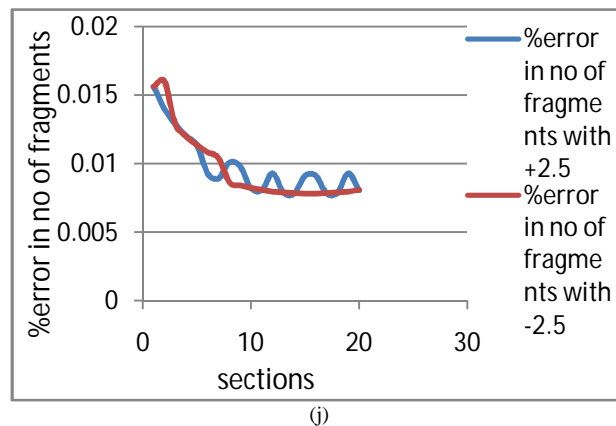

Fig.6. Graphs describing percent error when tolerances are given to ogive radius, left side radius and right side radius:(h) graph representing percent error in angle 2,(i) graph representing percent error in explosive mass,(j)graph representing percent error in number of fragments

The above Graph 6:(h),(i),(j) shows:

- The percentage error in angle2 when tolerance is applied to maximum diameter and left side and right side diameters. From the graph we can see the decrease in error in angle2 and for 13th section the error is zero.
- This point is the nearest point to arbitrary point from which the angle2 is measured. Again after that there is increase in error. This shows that there is least effect of tolerance on the section having the arbitrary point.
- We minimize the weight of warhead we calculate the casing mass, for this purpose the material used for casing is aluminum.

VI. CONCLUSION

Ogive shaped warheads, used in missiles consists of few tolerances problem. We here consider ogive shaped casing of radius 600mm and maximum diameter as 300mm. For this casing we take left side distance as 300mm and right side distance as 100mm. Thickness taken for this casing is 3mm and by programming in Matlab we got projection angles, explosive mass, casing mass, volume and by giving tolerance we get few errors in number of fragments and explosive mass and projection. A detailed analysis is carried out about errors. This will help in performance analysis of ogive shaped warheads. This will also help in getting the maximum mass a warhead can carry.

Ogive shape warhead used in missiles are having few tolerances problems which are satisfied in our project to a certain extent. This will help in the projection of fragments in the desired directions. Further, this would help in proper explosion of fragments and help to carry maximum mass in the warhead. Also, we would have given tolerances to fragments.

REFERENCES

- [1] George Kaisarli, ChristoferProvatidis, "Cad-Based Dimensional and Geometrical Tolerancing implementation by the use of virtual gauges: a case study", Machine Design Bol.3, 26 Sept 2011, PP. 205-210
- [2] General Tolerances, Part-1 Tolerances for Linear and Angular Dimensions without Individual Tolerances, ISO 8062/1984 Casting- System of Dimensional Tolerances Feb 1993, 2017-1985
- [3] General Tolerances, Part-2 Tolerances for Linear and Angular Dimensions without Individual Tolerances, Bureau of Indian Standards, Mar 1993, ISO 2768-2: 1989
- [4] Technical Drawings- Geometrical Tolerancing, Part-2 maximum material principles, Bureau of Indian Standards, Nov 1992, ISO 2692: 1988
- [5] Technical Drawings- Geometrical Tolerancing, Part-3 dimensioning and tolerancing of profiles, Bureau of Indian Standards, Nov 1992, ISO 1660: 1987
- [6].H.G. Conway," Engineering Tolerances", 3rd ed, 1966.
- [7] R.K. Jain, "Engineering Metrology", Khanna Publishers, 1986.
- [8] www.wikipedia.com