

International Journal of Innovative Research in Science, Engineering and Technology

(An ISO 3297: 2007 Certified Organization)

Website: www.ijirset.com

Vol. 6, Issue 2, February 2017

Motion Analysis of Deltoid Mechanism

Priyesh Pradeep Revankar

UG Student, Department of Mechanical Engineering, Government College of Engineering, Jalgaon, Maharashtra, India

ABSTRACT: The deltoid linkage is a type of four bar linkage mechanism in which the length of adjacent links are equal. At such condition when one of the shorter link is fixed, then crank-crank or double crank mechanism is obtained. It means one shorter and one longer link acts as crank and other longer link as coupler between them. Thus, when longer link is rotated once, shorter link completes two rotation and when shorter link is rotated twice, longer link completes only one rotation. The main purpose of this research is to analyze the motion of deltoid mechanism and determine what type of motion does it transmits. As no research has been done before on such mechanism this analysis is carried out manually, i.e. by observing and drawing the angle of rotation of both the cranks with respect to each other. The model of deltoid mechanism is drawn by using CATIA V5R19.

KEYWORDS: Deltoid, link, motion, crank, Grashof.

I. INTRODUCTION

In engineering, mechanisms and machines are two very common and frequently used terms. A moving body has to be assigned coordinates according to the axes assigned. The motion of the bodies is constrained according to the requirement in a mechanism. The links which are the basic elements of the mechanism are connected to form kinematic pairs which are of different types. The links may further be connected to several links in order to impart motion and they are classified accordingly. The four bar chain has four links which are connected with each other with the help of four lower kinematic pairs. This chain provides different mechanisms of common usage.

II. LITERATURE SURVEY

Most of the four bar linkages depends on Grashof's law. Applying Grashof's law we determine if the input and output links are a crank (**C**) or a rocker (**R**). A crank enjoys full 360 degree rotation while a rocker has a rotation that is a subset of this full rotation. Grashof's condition states that "For a four-bar mechanism, the sum of the shortest and longest link lengths should not be greater than the sum of two remaining link lengths". With a given four-bar mechanism, the Grashof Condition is satisfied if $L+S$ is less than or equal to $P+Q$ where S and L are the lengths of the shortest and longest links, and P and Q are the lengths of the other two intermediate-sized links. If the Grashof condition is satisfied, at least one link will be fully rotatable, i.e. can rotate 360 degrees.

III. WORKING AND ANALYSIS

The deltoid mechanism also depends upon Grashof's law, i.e., when $(a + d)$ is equal to $(b + c)$ Grashof's law is satisfied, where a , b , c & d are length of links as shown below. When one of the shorter link in four bar chain is fixed, the motion obtained is double crank or drag link motion. This is the basic working principle of deltoid linkage. The below figure.1 shows the line diagram of working of deltoid linkage.

In order to perform analysis of motion of deltoid linkage, the rotational movement of two cranks, i.e. crank-1 & crank-3 are compared with each other. They can also be called as longer and shorter cranks respectively. As we know that, this mechanism can be mostly used in applications where we require velocity ratio of 2:1 or 1:2 which depends upon the driver and driven link selected, to transmit uniform power shorter link must rotate exactly twice the rotation of longer

International Journal of Innovative Research in Science, Engineering and Technology

(An ISO 3297: 2007 Certified Organization)

Website: www.ijirset.com

Vol. 6, Issue 2, February 2017

link. Thus the main purpose of this analysis is to determine whether the power transmitted by one link to other is uniform or not. The below image.1 shows the model of deltoid mechanism drawn using CATIA software& also only few positions of the two cranks with respect to each other are shown below, as position of two cranks at every particular angle cannot be shown here due to limited space.

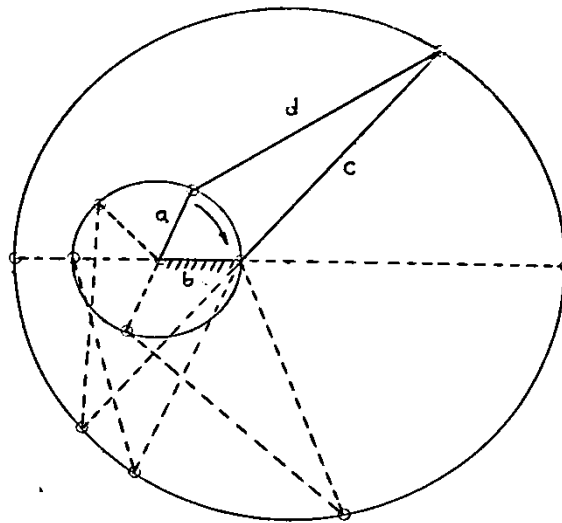

Figure. 1

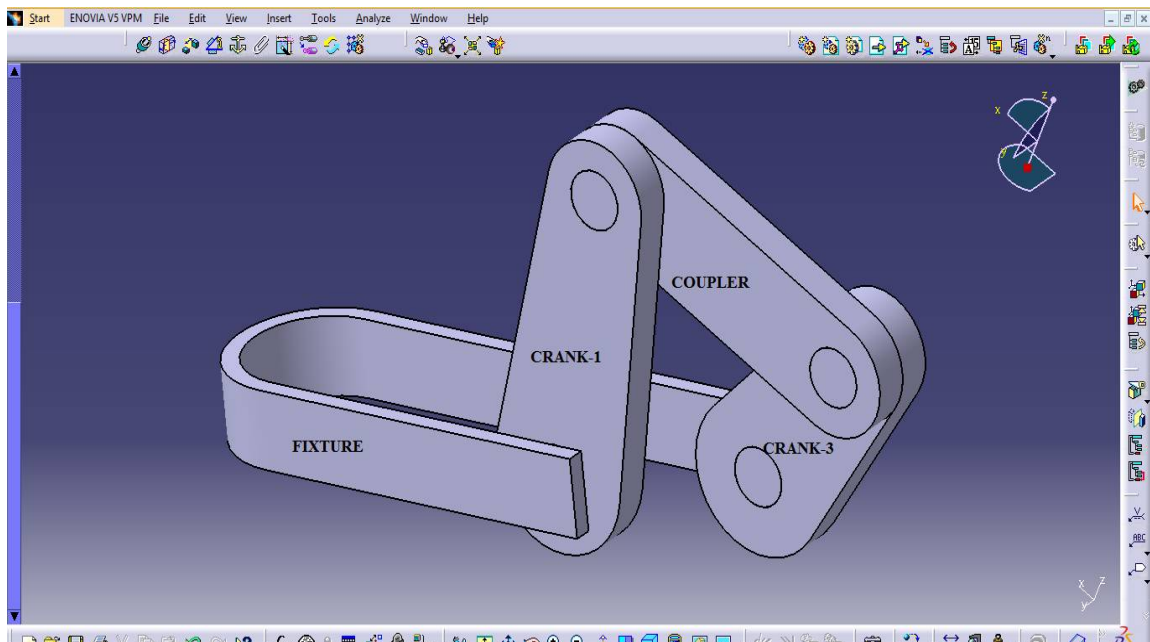

Image. 1

International Journal of Innovative Research in Science, Engineering and Technology

(An ISO 3297: 2007 Certified Organization)

Website: www.ijirset.com

Vol. 6, Issue 2, February 2017

Figures representing motion of two cranks with respect to each other from reference position.

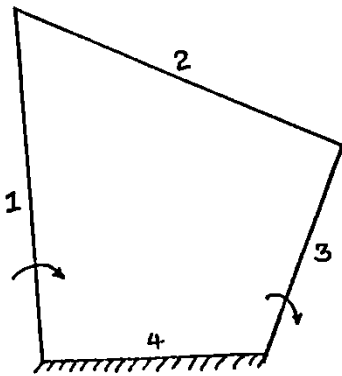

1. Reference positions of cranks

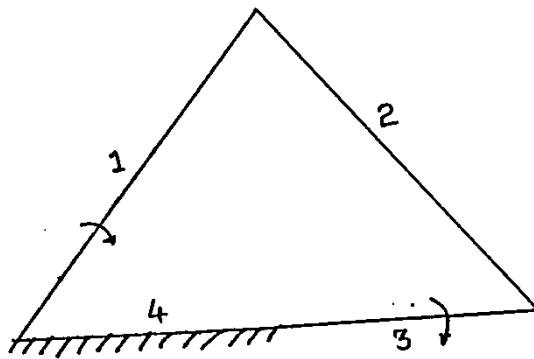

2. Crank-1 rotated by 40°

As we see above, first figure shows the reference positions of all the four links. This means that all the angular measurement of Crank 1 & 3 are measured from this reference positions. Second figure shows the angular displacement of Crank-3 when Crank-1 is rotated by 40° .

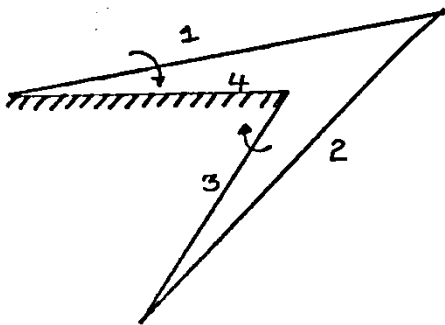

3. Crank-1 rotated by 80°

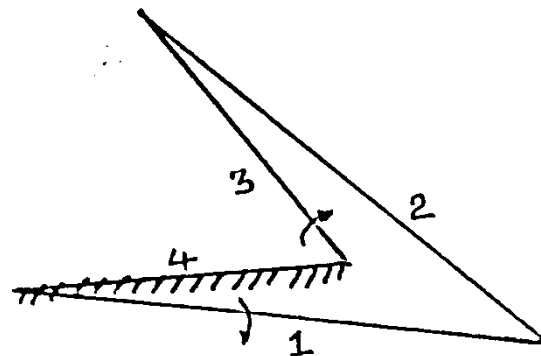

4. Crank-1 rotated by 100°

Third and fourth figure shows the angular displacement of Crank-3 when Crank-1 is rotated by 80° and 100° respectively.

International Journal of Innovative Research in Science, Engineering and Technology

(An ISO 3297: 2007 Certified Organization)

Website: www.ijirset.com

Vol. 6, Issue 2, February 2017

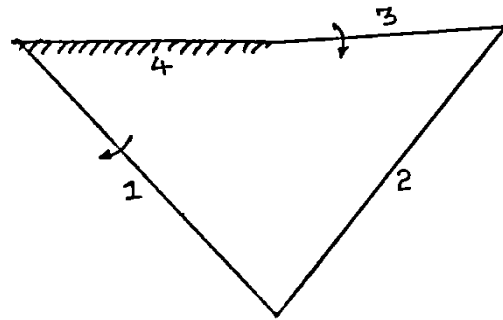
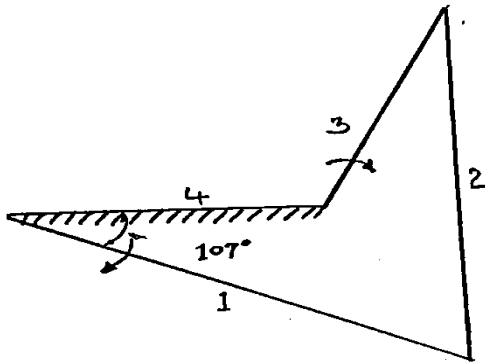

5. Crank-3 completes one rotation when Crank-1 is at 107° 6. Crank-1 rotated by 140°

Fifth figure shows the position of Crank-1 when Crank-3 completes one rotation which occurs at 107° whereas sixth figure shows position of Crank-3 when Crank-1 is displaced by 140° .

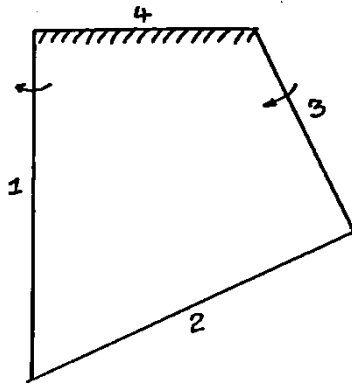

7. Crank-1 rotated by 180°

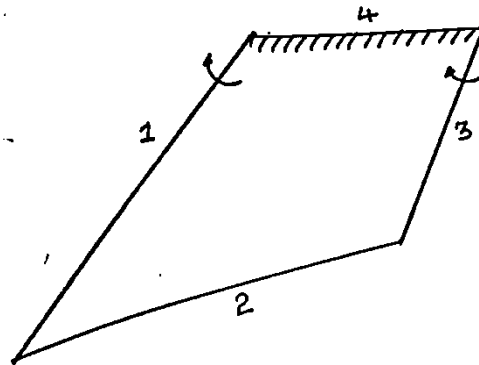

8. Crank-1 rotated by 220°

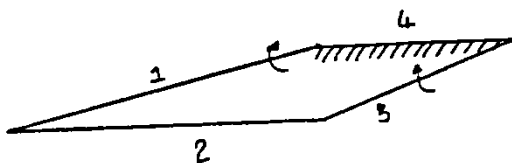

9. Crank-1 rotated by 240°

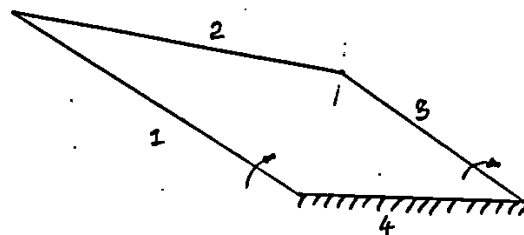

10. Crank-1 rotated by 300°

International Journal of Innovative Research in Science, Engineering and Technology

(An ISO 3297: 2007 Certified Organization)

Website: www.ijirset.com

Vol. 6, Issue 2, February 2017

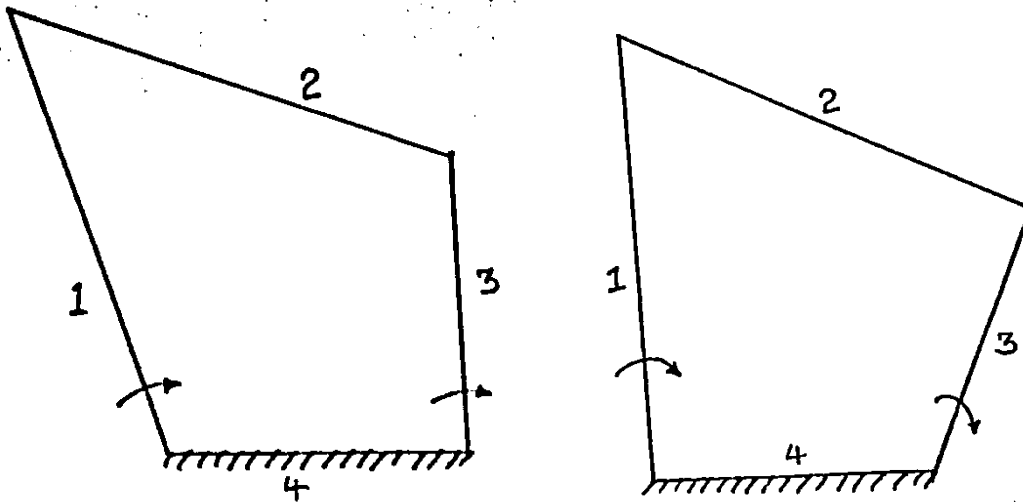

11. Crank-1 rotated by 340°

12. Crank-1 rotated by 360°

Thus, similarly all the above figures represent angular positions of Crank-3 with their respective positions of Crank-1.

IV. RESULTS

The determined values of angular rotation of crank-3 with respect to crank-1 from the reference position are given below in tabular form.

Rotation of Crank-1	Rotation of Crank-3	Rotation of Crank-1	Rotation of Crank-3
20	29	200	514
40	64	220	539
60	113	240	567
80	188	260	588
100	299	280	604
120	354	300	639
140	424	320	664
160	457	340	692
180	488	360	720

The graph with rotation of Crank-1 on x-axis and Crank-3 on y-axis is shown below. This is plotted by using above readings.

International Journal of Innovative Research in Science, Engineering and Technology

(An ISO 3297: 2007 Certified Organization)

Website: www.ijirset.com

Vol. 6, Issue 2, February 2017

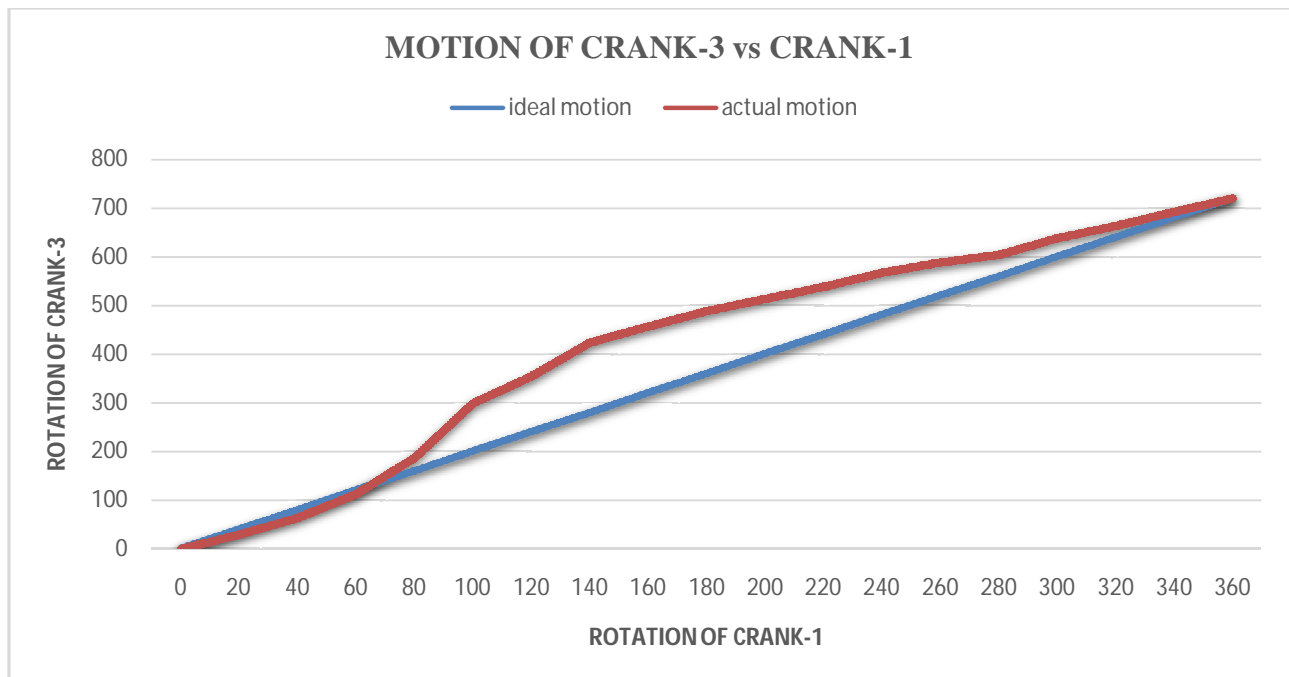

V. CONCLUSION

The above graph consists of two lines, i.e. red and blue. Blue line indicates ideal motion i.e., when rotation of crank-3 is proportional to crank-1 whereas red line indicates actual motion of deltoid mechanism. Here uniform motion is considered as ideal one. As red line diverts from blue line, we understand that motion is not uniform. In order for the motion to be uniform, it must follow blue line.

Thus, from the analysis it can be concluded that a deltoid mechanism transmits non-uniform power. The motion obtained at the output shaft, whether it may be from longer crank or shorter one, it is non uniform. This turns to be main disadvantage of using deltoid mechanism.

ACKNOWLEDGEMENT

I would like to thank specially Mr. HanmantDongale an UG student in our college for his technical help and support for preparing this research paper.

REFERENCES

- [1] <http://ocw.metu.edu.tr>
- [2] Dr. Robert L. Williams II "Mechanism Kinematics & Dynamics" Mechanical Engineering, Ohio University Notes Book Supplement for ME 3011 Kinematics & Dynamics of Machines © 2016 Dr. Bob Productions.
- [3] S S Rattan, "Theory of Machines" Tata McGraw Hill, second edition.