

# International Journal of Innovative Research in Science, Engineering and Technology

(An ISO 3297: 2007 Certified Organization)

Website: [www.ijirset.com](http://www.ijirset.com)

Vol. 6, Issue 2, February 2017

## Design and Analysis of FSAE Rollcage

Pruthviraj Vitthal Wable

UG Student, Department of Mechanical Engineering, Trinity college of Engineering and Research, Pune,  
Maharashtra India

**ABSTRACT:** This paper involves in detail description of overall design considerations, static and dynamic analysis of FSAE roll cage. Formula SAE (FSAE) competitions offers a challenging environment where an engineering student can practice and develop various engineering skills. This increases the practical and application oriented approach towards a real engineering. This paper deals with the overall of design procedure of roll cage of FSAE vehicle from start to end, as well as Finite Elemental Analysis (static & dynamic) of it. 3D CAD model of roll cage is made using CREO 2.0 software and FEA analysis is done using ANSYS 17.0.

**KEYWORDS:** FSAE, roll cage, Finite Elemental Analysis, CREO 2.0, ANSYS 17.0.

### I. INTRODUCTION

The objective of the study is to design and develop roll cage of FSAE vehicle. Roll cage is a tubular space frame of a vehicle as well as it provides a protected space around a driver, it ensures safety of a driver in worst cases like crash or rollover. All other automotive sub systems like engine, brakes, steering are mounted on rollcage. Rollcage need to be satisfy number of requirements such as Rules given by SAE must be satisfied in order to qualify in the dynamic events such as skidpad, autocross and endurance [1]. In order achieve high performance rollcage plays an important role. If the weight of rollcage will be more it will reduce the overall performance of the vehicle. So material selection plays a key role in rollcage design. Proper material selection taking in consideration the factor of cost is important. Design is done keeping in mind the safety of driver, ergonomics and manufacturing point of view. As we can design anything but during actual manufacturing there may be problems. By keeping in mind all the above point's rollcage is designed. After the design of rollcage we should ensure that it is safe for a driver in worst cases [3]. For that we have to carry out a finite elemental analysis on the rollcage. FEA/FEM is most effective method as we don't need an actual prototype for testing so it is cheaper method. We have to do static as well as dynamic analysis of rollcage in order to get an actual idea of total deformation and stress which is generated in various cases like Front impact, rear impact, side impact and torsional analysis of rollcage.

This paper will give brief idea about the design parameters which are to be considered as well as how to design and optimize the rollcage considering the safety of driver and overall performance of the vehicle.

### II. DESIGN METHODOLOGY

Rollcage is a tubular space frame it may consists of a bars of circular crossection or square crossection [3]. In our rollcage only circular bars are used. As per the rule given in FSAE rule book the seamless bars of uniform crossection with 25.4mm outer diameter and 1.65mm/2.5mm wall thickness [1] must be used depending upon the strength requirement.

### III. MATERIAL SELECTION

One of the key decision about the rollcage is material selection as it has a great impact on safety, reliability and performance. To ensure the optimal selection of material extensive research is carried out and comparison between the chemical and mechanical properties are for various material is done [3]. For selecting the material for the Rollcage,

# International Journal of Innovative Research in Science, Engineering and Technology

(An ISO 3297: 2007 Certified Organization)

Website: [www.ijirset.com](http://www.ijirset.com)

Vol. 6, Issue 2, February 2017

the important properties of the frame material to be considered include high rigidity, torsional stiffness, stability and low weight so as to satisfy the requirements of a race car.

After the extensive research in market, there were two best options for us.

1. **AISI 1018**
2. **AISI 4130**

Properties	Value	
	AISI 1018	AISI 4130
Density	7870 Kg/m <sup>3</sup>	7870 Kg/m <sup>3</sup>
Poisson's Ratio	0.29	0.29
S <sub>ut</sub>	450 Mpa	845 Mpa
S <sub>yt</sub>	365 Mpa	790 Mpa
Elasticity (E)	200 Gpa	200 Gpa

**Table no. 1**

Table no. 1 shows the comparison between the mechanical properties of AISI 1018 and AISI 4130. We can see that mostly all properties are same except the values of ultimate strength and yield strength.

### Chemical Composition AISI-4130

Carbon	0.28 - 0.33%
Chromium	0.8 - 1.1%
Manganese	0.7 - 0.9%
Molybdenum	0.15 - 0.25%
Phosphorous	0.035 max
Silicon	0.15 - 0.35%
Sulphur	0.04 max

**Table no. 2**

Carbon	0.14-0.20 %
Iron	98.81-99.26 %
Manganese	0.6-0.9 %
Phosphorous	≤ 0.040 %
Sulphur	≤ 0.050 %

**Table no. 3**

We can see that the ultimate tensile strength of AISI 4130 is twice the ultimate tensile strength of AISI 1018. It means that AISI 4130 provides high strength to weight ratio.

Table no. 2 and 3 shows chemical properties of AISI 4130 and AISI 1018 respectively. From Table no. 2 we can see that it consists of Chromium, Molybdenum and Phosphorous, so various properties like Machinability, chip formation and corrosion resistance is higher in AISI 4130.

By comparing a cost of both we came to a conclusion that the cost of AISI 4130 is higher than the AISI 1018 but it is superior than AISI 1018 in all other required properties.

Hence we have selected **AISI 4130** material for Rollcage,

## IV. BASIC DESIGN

While designing three main factors are considered:-

- 1 **Safety of driver**
- 2 **Ergonomics**
- 3 **Manufacturing**

## International Journal of Innovative Research in Science, Engineering and Technology

(An ISO 3297: 2007 Certified Organization)

Website: [www.ijirset.com](http://www.ijirset.com)

Vol. 6, Issue 2, February 2017

Driver gets a maximum safety through the rollcage as we have selected the material which have high strength to weight ratio, as well as in minimum weight there is more strength to rollcage. As by this we have satisfied 50% of first factor.

Now coming to the second factor that is **Ergonomics**.

Ergonomics stands for man and machine relationship. It means that we have to design a car as per the driver's requirement. As rollcage is the main base component of the car and all other automobile sub systems are mounted on it so we have to consider ergonomics while designing a rollcage.

Designing of the rollcage must be started from the base of the rollcage. From that we can get an idea about the overall length of the rollcage, position of driver and position of other sub systems on rollcage.

The driver cockpit is decided as per the physique of the driver as well as it should satisfy the rules given in rulebook. At first time consider all the allowances and after 3-4 iterations you can get an actual length.

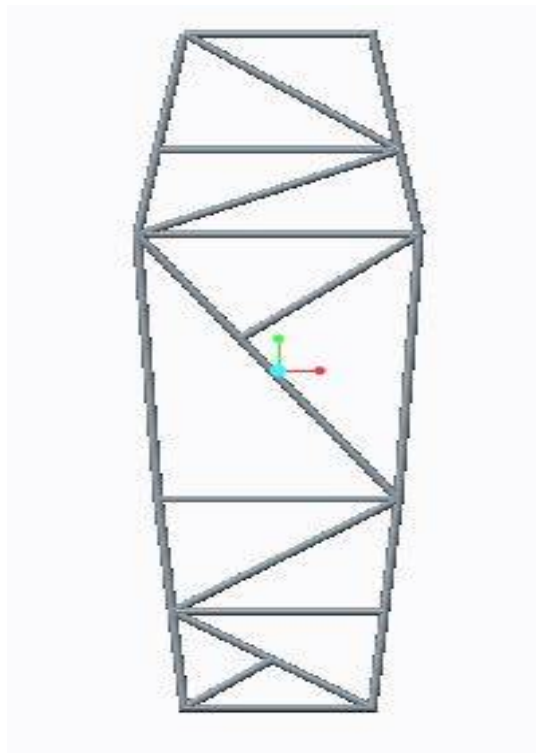
You can carry out this by considering seating posture of driver and size of other sub systems. **Fig.1** shows the dimensions of the base frame which are drawn the ground. This is carried out in the initial stages of designing. After doing proper analysis of factors like seating position of driver and position of other sub systems the final base frame is made.

**Fig.2** shows the final CAD model of base frame, which are made completely according to the driver physique and proper space utilization. The main challenge was to design a compact frame without compromising the driver comfort and ergonomics.

CAD model is really important in order to analyse the rollcage for various cases like front impact, rear impact, side impact and torsional analysis. The CAD model of the rollcage is given as an input geometry in ANSYS 17.0 for analysis in the form of IGES file. Various options of CAD software like CATIA, CREO, and SOLIDWORKS were available. From those we choose CREO 2.0 for modelling a rollcage.



**Fig.1 Initial rough dimensions of base frame**



**Fig.2 Final CAD model base frame**

# International Journal of Innovative Research in Science, Engineering and Technology

(An ISO 3297: 2007 Certified Organization)

Website: [www.ijirset.com](http://www.ijirset.com)

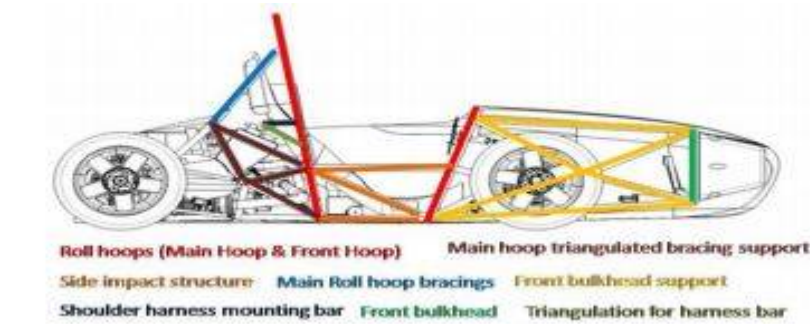
Vol. 6, Issue 2, February 2017

## V. ROLLCAGE DESIGN

After the base of the rollcage is fixed, we have to start with other components of rollcage like mainhoop, fronthoop, front bulkhead, bracings [1].

Design procedure of any road vehicle begins with tires [9], the tires are the only point of contact between road and vehicle. The main task is to find the tire's optimal range of operation considering slip angle, inclination angle and various loading conditions. After considering various factors suspension hard points (pick up points) are determined [6]. With the reference of the previously designed base frame the coordinates of pick up points are plotted in space. Using creo parametric software. After getting all the suspension pickup points, these points are connected to form a whole rollcage. The main reason of finding the suspension pickup points before the complete rollcage is that those point must be at **nodes**. In our case front suspension pickup points are on nodes as we have first find the points and after that we have designed the front bulkhead. Rear suspension pickup points are not on nodes. A node to node triangulations are done in order to have a proper stress flow through it.

Various others parameters like position of side impact member are properly fixed from ground as per the rules given in rulebook [1].



**Fig.3 Various components of rollcage [1]**

By considering the rules given in the rulebook the whole rollcage is designed. After the completion of design all the rules are checked using check sheet provided by the organisers the competition. If some rule is violated then again the designed is changed. **Fig.3** shows the location of various components like Roll hoops, bracings and all other triangulations. By taking in consideration

Now coming to another important consideration in design that is **manufacturing point**.

As we have discussed earlier that we can design anything in cad software but in actual practice is difficult execute the design. So while design of rollcage must be simple and easy.

If the manufacturing point is not kept in mind then there will be high chance of manufacturing defect in the whole structure of rollcage. Various tolerances must be considered for cutting and welding operation which are to be used in manufacturing phase of rollcage.

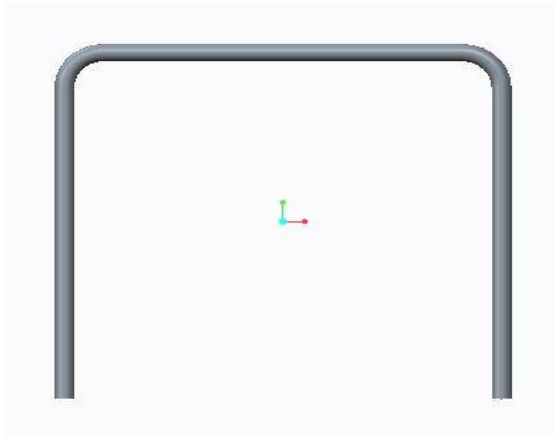
There must be a good communication between the design team and manufacturing team. If this is not the case then design team will design something and manufacturing team will manufacture something else. There must a good coordination between the two.

## International Journal of Innovative Research in Science, Engineering and Technology

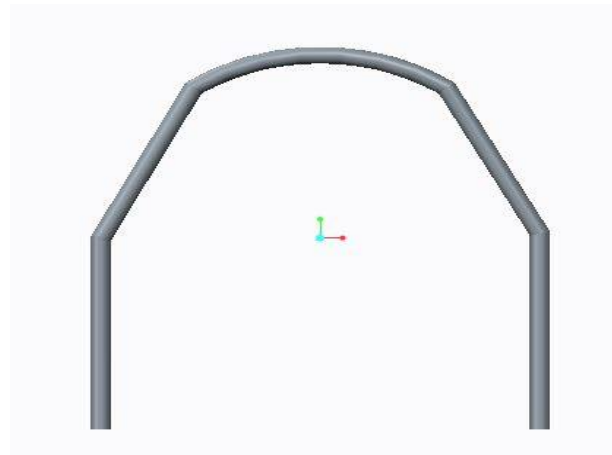
(An ISO 3297: 2007 Certified Organization)

Website: [www.ijirset.com](http://www.ijirset.com)

Vol. 6, Issue 2, February 2017

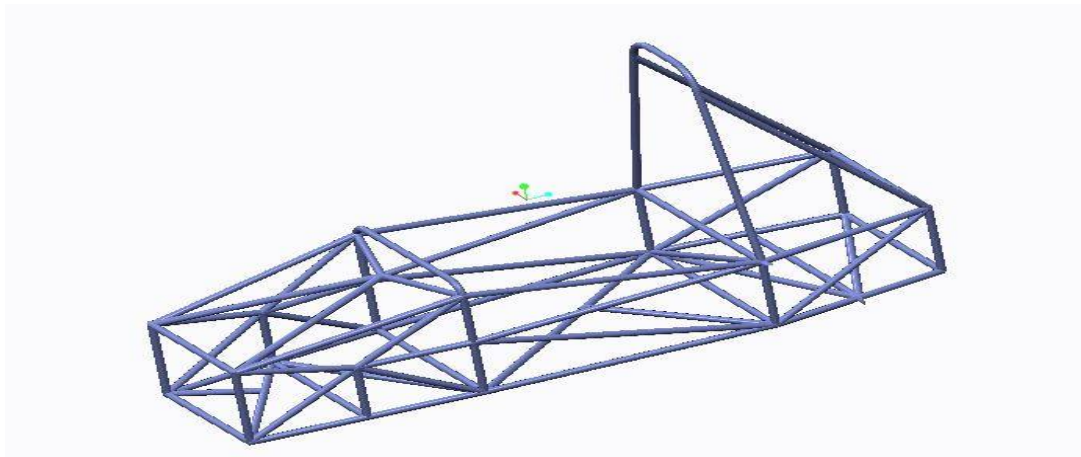


**Fig 4:- Front hoop 1**



**fig 5:- Front hoop 2**

From **Fig. 4** and **5** we can see that both the front hoops are as per the rule specified in rulebook [1] but **Fig.4** shows front hoop 1 which is quite easy to manufacture as there are less number of complicated bends. But **Fig.5** shows front hoop 2 which is difficult to manufacture and there are chances of manufacturing error. So the manufacturing point is really important while designing.



**Fig 6:- A Final 3D CAD model of designed rollcage using creo 2.0**

After considering the manufacturing point of view a complete rollcage is designed using a CAD software “CREO 2.0”. **Fig.6** shows the final CAD model of rollcage. After design is complete it is very important to make a prototype of whole rollcage. As by this we can place various sub systems in it and can make necessary changes in the design. Prototype is very important because driver can actually sit into it and can check various parameters like visibility, comfortable driving position. **Fig.7** shows the prototype made after design. Actual size of vehicle can be determined using this prototype. By this we can also get an idea about the critical welds present in the rollcage.

There are certain rules like rule for the clearance between driver helmet and topmost point of main hoop, this rule cannot be checked and confirmed without the prototype [1]. This prototype is mostly made with PVC pipes as they are

# International Journal of Innovative Research in Science, Engineering and Technology

(An ISO 3297: 2007 Certified Organization)

Website: [www.ijirset.com](http://www.ijirset.com)

Vol. 6, Issue 2, February 2017

available in same outer diameter as that of 4130 steel tubes and cost is also less. After the validation through prototype 80% process is complete.



Fig 7:- Driver seating position in the prototype made up of PVC pipes

## VI. FINITE ELEMENTAL ANALYSIS OF ROLL CAGE

The finite elemental analysis (FEA) of the roll cage is done using ANSYS 17.0. The stress analysis is done for the worst cases. Two types of analysis were carried out

1. Static analysis (2D)
2. Dynamic analysis

Various analysis like Front impact, rear impact, side impact, and torsional analysis of rollcage is carried out using ANSYS 17.0.

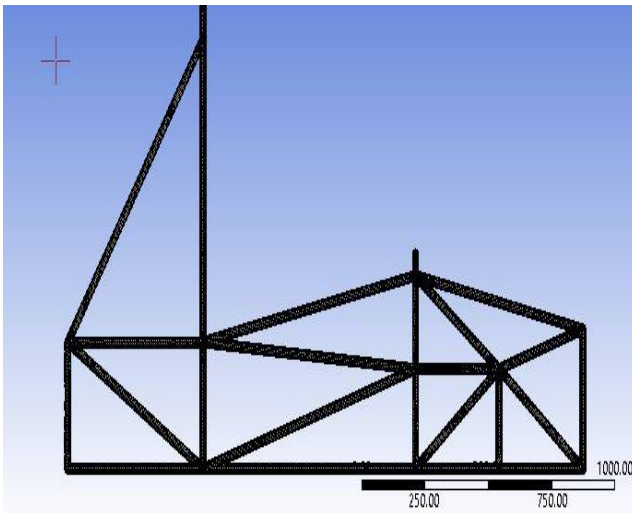


Fig 8:- Mesh model of rollcage

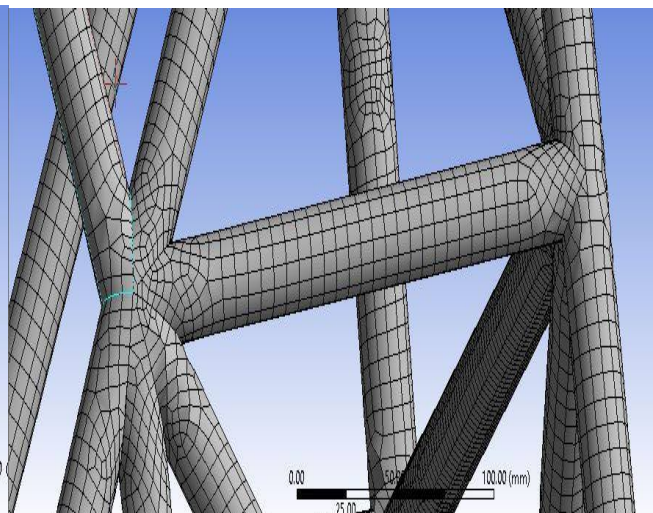


Fig 9:- Enlarged view of mesh model

While meshing the element size is kept as 3mm in size. The generated mesh consists of mostly quad element. For getting good results meshing plays an important role. We have carried out surface meshing (2D). **Fig.8** shows the mesh model of the rollage in ANSYS 17.0 as the mesh size is kept small so it is elements are not visible. **Fig.9** show the enlarged view of meshed model. We can see that mostly all quad elements are generated as well as the mesh is also uniform.

Static analysis means that the rollage is stationary and we are applying the force on it by applying various constraints on the rollage. The force applied is the form of G FORCE.

**Static Calculations [2]** are done by knowing the Deceleration at which the vehicle get impact and result in Stress and Deformation, calculated as

$$\text{Weight} = W = 250\text{KG}$$

$$G = W * 10 = 2500 \text{ N} = 1G, \text{ Similarly}$$

$$2G = 2 * 2500 = 5000 \text{ N}$$

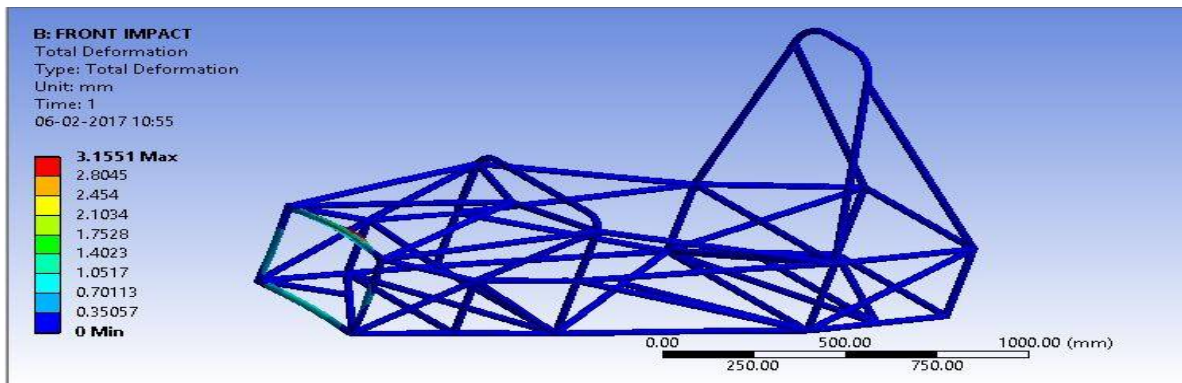
$$3G = 3 * 2500 = 7500 \text{ N}$$

$$4G = 4 * 2500 = 10000 \text{ N}$$

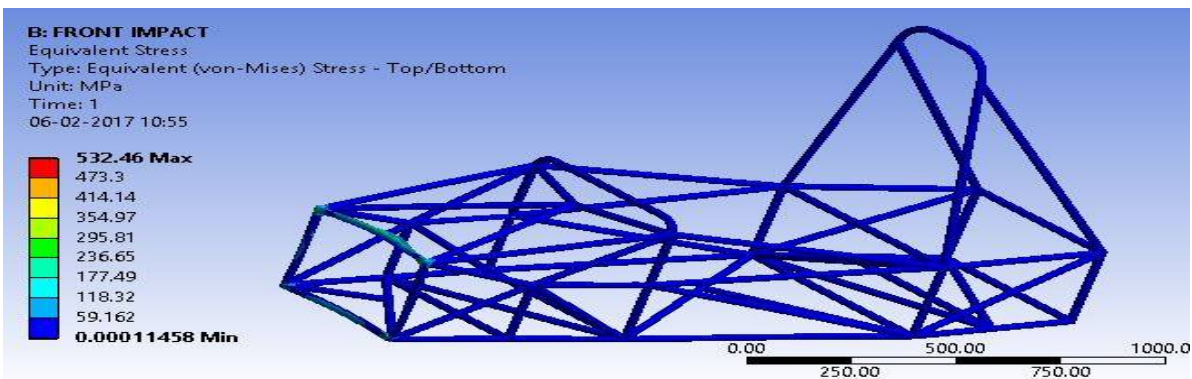
## 1. STATIC ANALYSIS

### 1. FRONT IMPACT

**Fig.10** and **11** shows the results of deformation and stress induced after FRONT IMPACT in rollage. Force of **4G** applied on the front bulk head and rollage constrained at front and rear suspension pick up points.



**Fig 10:- Deformation in front impact = 3.15 mm**



**Fig 11:- Stress in front impact = 532.46Mpa FOS = 1.588**

2. REAR IMPACT

Fig.12 and 13 shows the results of deformation and stress induced after REAR IMPACT in rollage. Force of 4G is applied on the rear box and constraints are given on front and rear suspension pickup points.

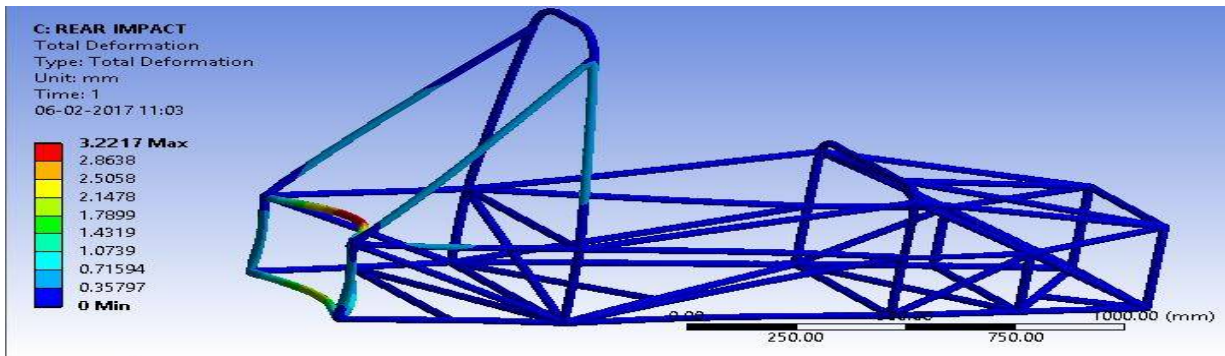


Fig 12:- Deformation in rear impact = 3.22 mm

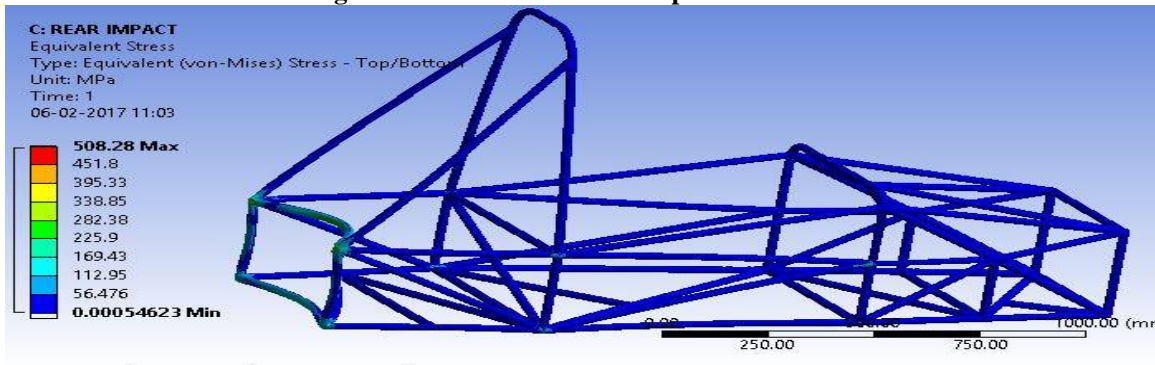


Fig 13:-Stress in rear impact = 508.2 Mpa FOS = 1.66

3. SIDE IMPACT

Fig.14 and 15 shows the results of deformation and stress induced after SIDE IMPACT in rollage. Force of 3G is applied on the side impact members and rollage constrained at front and rear suspension pick up points.

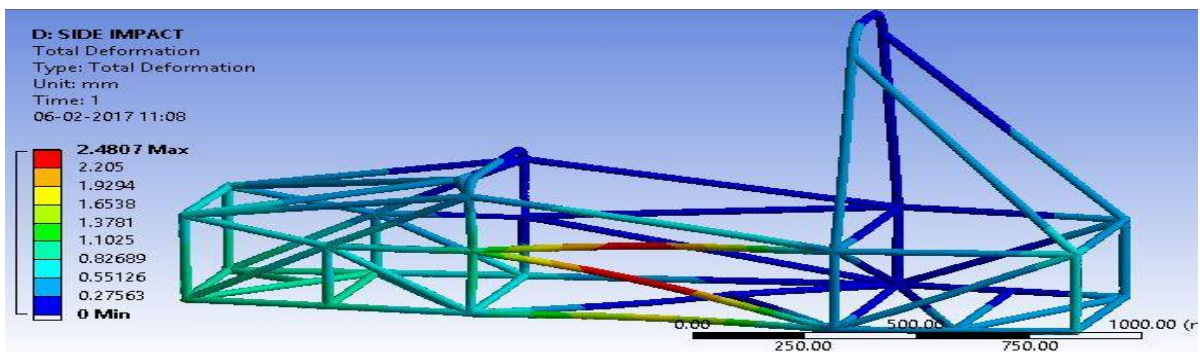
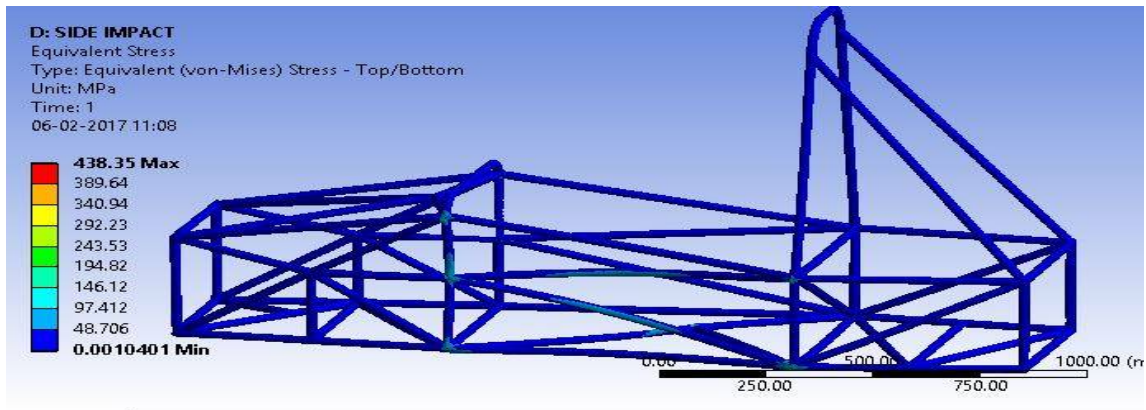


Fig 14:- Deformation in side impact = 2.48 mm

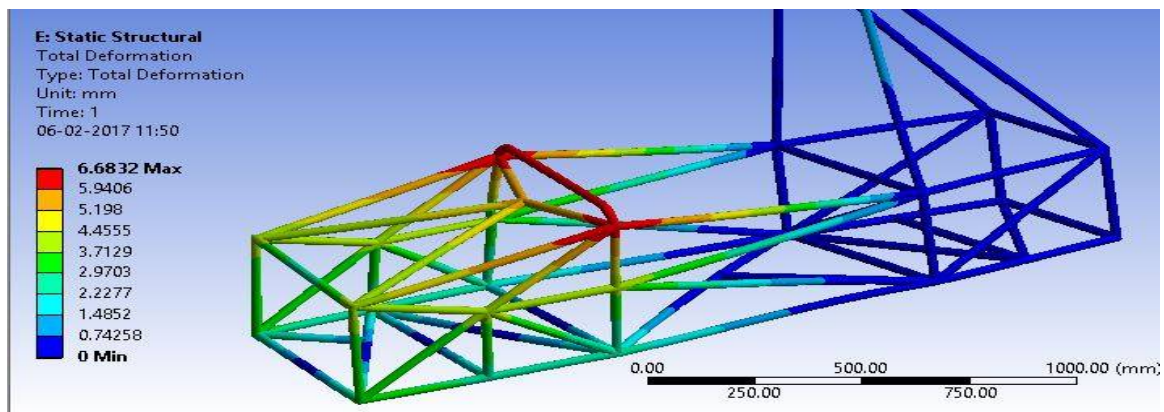




**Fig 15:-Stress in rear impact = 438.35 Mpa FOS = 1.9**

#### 4. TORSIONAL ANALYSIS

**Fig.16** shows result of Deformation when Torsion load of 3G applied on front suspension pick up points in anticlockwise direction. The constraints are applied on rear suspension pick up points.



**Fig 16:- Deformation in torsion = 6.68 mm**

#### 2. DYNAMIC ANALYSIS (EXPLICIT DYNAMICS)

**Dynamic Calculations** are done by applying velocity to rollage at which impact occurs

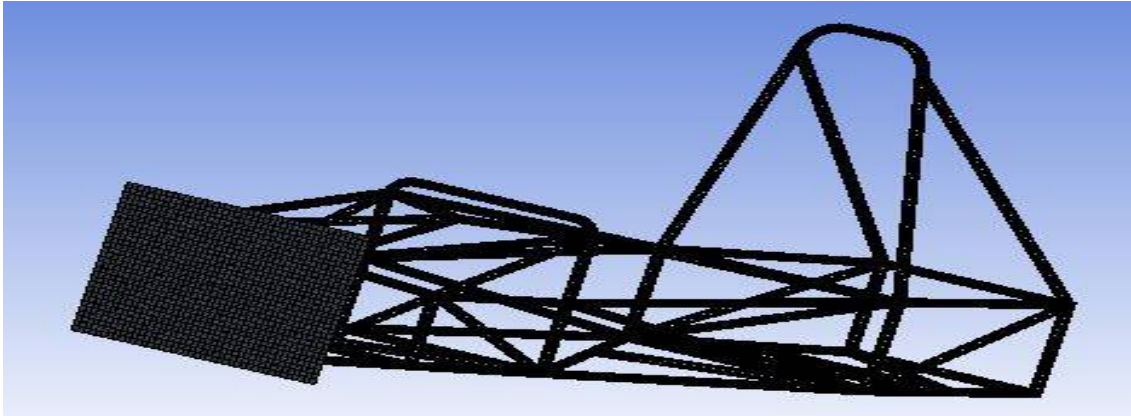
Weight = 250kg

Velocity = 16666.67 mm/s (rollage)

Distance = 20 mm i.e. distance of wall from rollage

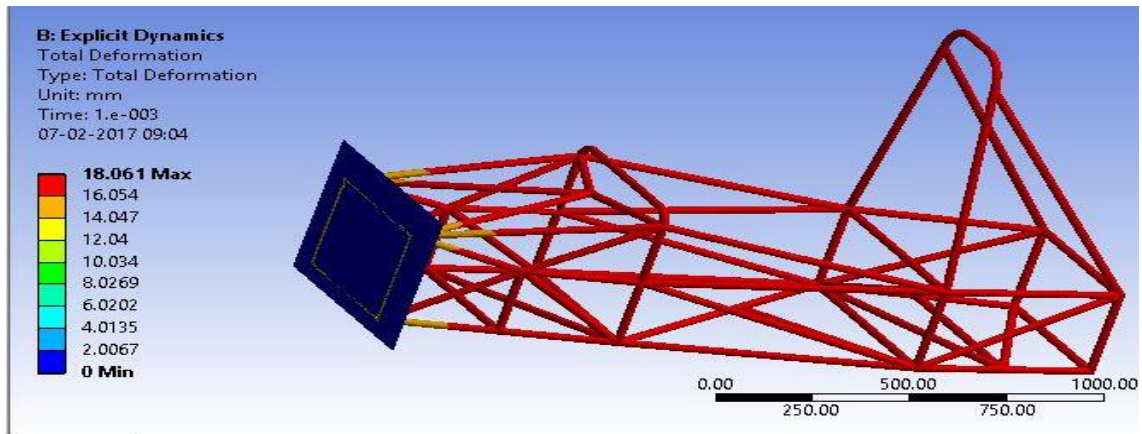
##### 1. FRONT IMPACT

For an explicit dynamics a new setup is to be done. A rollage is given a velocity of 16666.67 mm/s (60km/hr.) and rigid wall is made at a distance of 20mm from the rollage and that rigid wall is fixed. **Fig.17** shows the completely meshed model of rollage and rigid wall. Element size is kept as 3mm.



**Fig.17:- Meshed model for explicit dynamics with rigid wall**

**Fig.18** shows the results of deformation after front impact in dynamics. We can see that the deformation is more in dynamics condition. We have tested the rollage for actual condition. So we can say that the dynamic analysis gives more accurate results as compared to static analysis. It is same as a crash test carried out on commercial vehicles. Hence it is more preferable over static analysis.



**Fig.18:- Dynamics impact (FRONT) deformation = 18.0mm**

## VII. CONCLUSION

We have implemented a technique of rollage design for Formula SAE competitions from initial stage to final stage. As well as we have studied all the factors which are necessary to keep in mind while designing a rollage. We have done a Finite Element Analysis of the rollage (both in static and dynamic conditions) and hence we conclude that the rollage has required value of Factor of safety and it is safe for a driver.

## REFERENCES

- [1] SupraSAEIndiaRulebook2017, [http://suprasaeindia.org/images/downloads/SUPRA\\_SAEINDIA\\_2017\\_RULE\\_BOOK.pdf](http://suprasaeindia.org/images/downloads/SUPRA_SAEINDIA_2017_RULE_BOOK.pdf) page 14-33.
- [2] Mr.Virendra.S.Pattanshetti "design and analysis of Go-Kart chasis", International Journal of Mechanical and Industrial Technology ISSN 2348-7593 (Online) Vol. 4, Issue 1, pp: (150-164), Month: April 2016 - September 2016

## International Journal of Innovative Research in Science, Engineering and Technology

(An ISO 3297: 2007 Certified Organization)

Website: [www.ijirset.com](http://www.ijirset.com)

Vol. 6, Issue 2, February 2017

- [3] Upendra S. Gupta, Shubham Jain, Harsh Jain, Sameer Singh Rathi "Static & Dynamic Analysis of F-SEA Roll cage Vehicle" *International Journal of Engineering Trends and Technology (IJETT) – Volume 27 Number 5 - September 2015*
- [4] Deep Shrivastava "Designing of All Terrain Vehicle (ATV)" *International Journal of Scientific and Research Publications, Volume 4, Issue 12, December 2014* ISSN 2250-3153
- [5] .Sham Tickoo; ANSYS Workbench14.0: A tutorial approach ISBN 978-1-932709-96-4 2012. Page 9-40
- [6] Thomas D. Gillespie; Fundamental of Vehicle Dynamics; ISBN: 978-1-56091-199-9; February 1992. Page 22-26
- [7] Abhinay Nilawar, Harmeet Singh Nannade, Amey Pohankar, Nikhil Selokar, "DESIGN OF GO-KART", Maharashtra, India, IJFEAT, ISSN: 2321-8134.
- [8] Mr. Girish Mekalke, "STATIC ANALYSIS OF A GO-KART CHASSIS", IJMIT, Vol-3, Issue 2, pp: (73-78), ISSN 2348-7593, October 2015 - March 2016.
- [9] Herb Adams, "Chassis Engineering", Berkley Publishing Group New York. ISBN 1-55788-055-7 page 8-13
- [10] Introduction to Formula SAE Suspension and Frame Design Edmund F. Gaffney Iii and Anthony R. Salinas
- [11] Koustubh Hajare, Yuvraj Shet, Ankush Khot, "A Review Paper On Design And Analysis Of A Go-Kart Chassis", IJETMAS, Volume 4, ISSUE 2, ISSN 2349-4476, February 2016
- [12] Ammar Qamar Ul Hasan, "SIMULATION OF ATV ROLL CAGE TESTING", IOSR-JMCE, e-ISSN: 2278-1684, P-ISSN: 2320-334, Volume 12, Issue 3 Ver. II, Pp 45-49, May. - Jun. 2015.
- [13] <http://www.matweb.com/>