

Analysis of Some Electrical Circuits with the Help of Graph Theory Using Network Equilibrium Equations

Chanchal Boruah¹, Krishna Gogoi², Chandra Chutia³Assistant Professor, Department of Mathematics, Arya Vidyapeeth College, Guwahati, India¹Associate Professor, Department of Mathematics, D.C.B. Girls' College, Jorhat, India²Associate Professor, Department of Mathematics, Jorhat Institute of Science and Technology, Jorhat, India³

ABSTRACT: The electrical circuits are the main building blocks of electrical appliances. Without the electrical appliances today's civilization become fully paralyzed. Now-a-days Graph theory, a branch of Mathematics has impact on almost every other branch. In engineering mathematics also, graph theory plays a vital rule. Study of the properties of electrical circuits with the help of graph theory is a growing trend in mathematical and electrical fields. Electrical circuits consists of nodes and branches which obeys Kirchhoff's current laws, Kirchhoff's voltage laws etc. The scientists now-a-days engage themselves to construct simple cost effective circuits. There are various well known theorems such as Norton's theorem, Thevenin's theorem, Superposition theorem etc to construct simple circuits from the complicated circuits. In the graph of the circuits, all the elements of the circuits are replaced by lines with circles or dots at both ends. The lines represent branches and the dots represent nodes of the circuits. From these graphs, we can find matrices related to them by different rules. In this paper, we try to study electrical networks and its simplified circuits and their associated currents and voltages through network equilibrium equations which obey the laws of electricity.

KEYWORDS: Graph theory, Electrical circuits, Branch, Node, Matrix Representation, Branch current, Loop current, Adjacency matrix, Incident matrix, Impedance matrix, Branch admittance matrix.

I. INTRODUCTION

Graph theory is the branch for the study of proof techniques in discrete mathematics and its results have application in many areas of the computing, social and natural sciences.. Spectral graph theory is the study of the properties of a graph which describes the relation between the polynomial eigenvalues and eigenvectors of matrices associated with the graph.

GRAPH : A graph is a set of ordered pair $G = (V, E)$ of sets where $E = \{\{x, y\} : x, y \in V\}$. The elements of V are called vertices (or nodes) of the graph G and the elements of E are called edges. So in a graph a vertex set is a set of points $\{x_1, x_2, x_3 \dots x_n\}$ and edge is a line which connects two points x_i and x_j . Such graphs are called undirected graphs. A directed graph is similar to an undirected graph except the edge set $E \in V \times V$.

ELECTRICAL CIRCUITS : An electrical circuit consists of internally connected elements viz resistors, capacitors, inductors, diodes, transistors etc. The behaviour of an electrical circuits generally depends upon two factors.

- The characteristic of each of internally connected elements
- The rule by which they are connected together.

The second factor gives a relation between electrical circuits with graph theory. A two terminal electrical element can be represented by an edge e_k . Associate with each edge there are two variables $V_k(t)$ and $i_k(t)$. The variable $V_k(t)$ is

International Journal of Innovative Research in Science, Engineering and Technology

(An ISO 3297: 2007 Certified Organization)

Website: www.ijirset.com

Vol. 6, Issue 1, January 2017

called the edge voltage and may be regarded as cross variable because it exist across the two end points. The other variable is called edge current and may be regarded as through variable because it flows through the edge. These variables must also obey the two laws of Kirchoff's.

Kirchoff's Current Law (KCL): For any lumped electrical network, at any time the net sum (taking into account the orientations) of all the currents leaving any node or vertex is zero. That is at r^{th} vertex of the corresponding digraph, we must have

$$\sum_{k=1}^e a_{rk} i_k(t) = 0$$

Where a_{rk} is the rk^{th} entry of the incidence matrix A of G and $i_k(t)$ is the amount of current flowing through the k^{th} edge of G .

Kirchoff's Voltage Law (KVL) : For any lumped electrical network, at any time the net sum (taking into account the orientations) of the voltages around a loop (i.e. circuit) is zero. In terms of the corresponding digraph, for the r^{th} circuit we must have

$$\sum_{k=1}^e b_{rk} v_k(t) = 0$$

Where b_{rk} is the rk^{th} entry of the circuit matrix B of G and $v_k(t)$ is the amount of voltage across the k^{th} edge.

II. FROM CIRCUIT TO GRAPH

A graph can be obtained from a circuit. We identify the graph $G=(V, E)$ where V is the set of vertices and E is the set of edges. The edge between i^{th} and j^{th} vertices can be denoted by $\{i,j\}$ ignoring the direction. Similarly the notation (i,j) can be used for oriented edges, where i is the start vertex and j is the end vertex. For example consider the circuit and its graph in the figure. There are five vertices and seven edges in the graph obtained from the given circuit. An edge is sometimes called branch and a vertex is called node in case of electrical circuits.

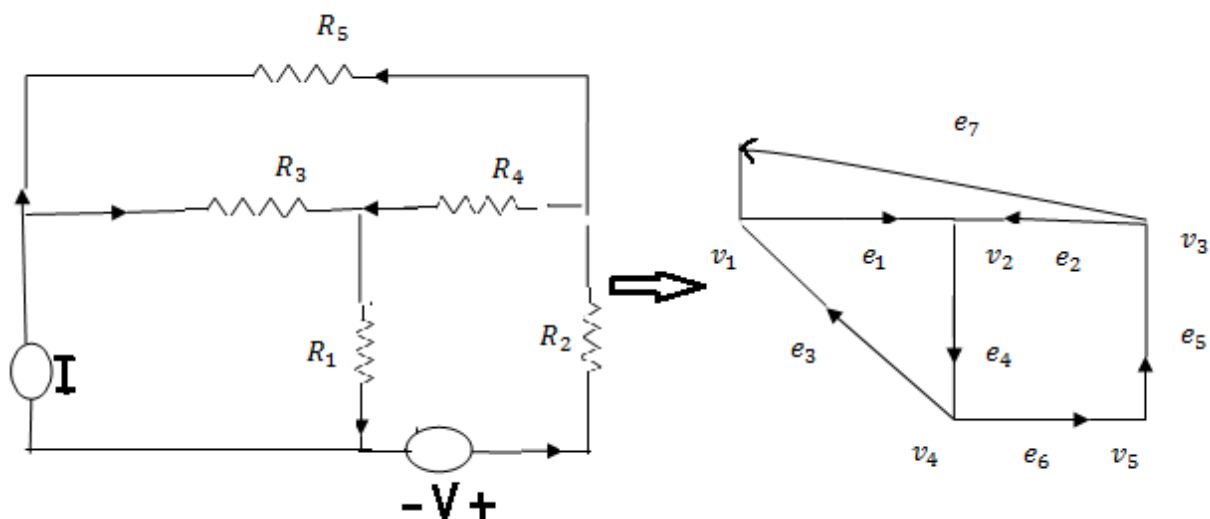

Fig: A circuit and its corresponding graph

International Journal of Innovative Research in Science, Engineering and Technology

(An ISO 3297: 2007 Certified Organization)

Website: www.ijirset.com

Vol. 6, Issue 1, January 2017

MATRICES ASSOCIATED TO A GRAPH

1) Adjacency matrix:

Let G be a graph without multiple edges. The *adjacency matrix* is the 0-1 matrix A indexed by the vertex set V of G , where $A_{xy} = 1$ when there is an edge from x to y in G and $A_{xy} = 0$ otherwise. In multi graphs A_{xy} equals the number of edges from x to y .

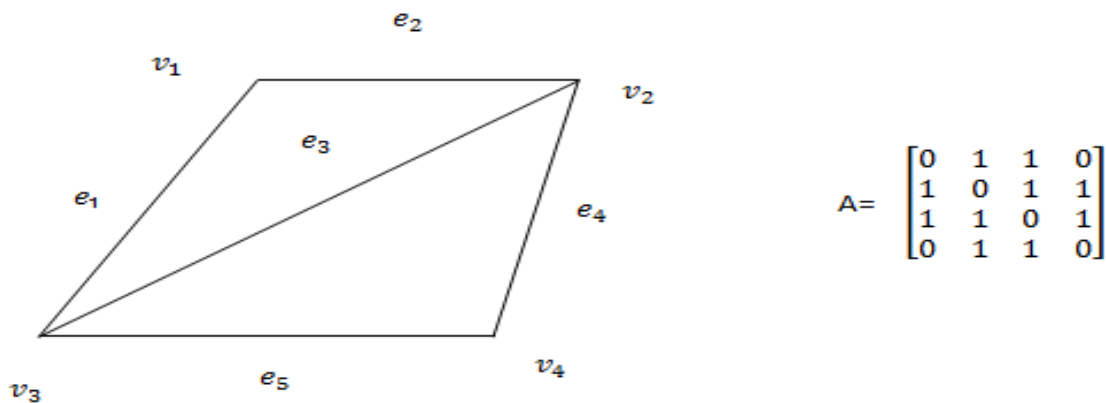

Fig: A matrix and its adjacency matrix

2) Incidence matrix:

Let G be an undirected graph without loops. The (vertex-edge) *incidence matrix* of G is the 0-1 matrix M , where rows represent the vertices and columns represent the edges, where $M_{xe} = 1$ when vertex x is an endpoint of edge e . Let G be a directed graph without loops. The *directed incidence matrix* of G is the 0-1 matrix N , with rows represent vertices and columns represent edges, where $N_{xe} = -1, 1, 0$ when e starts at x , e ends at x , or otherwise respectively.

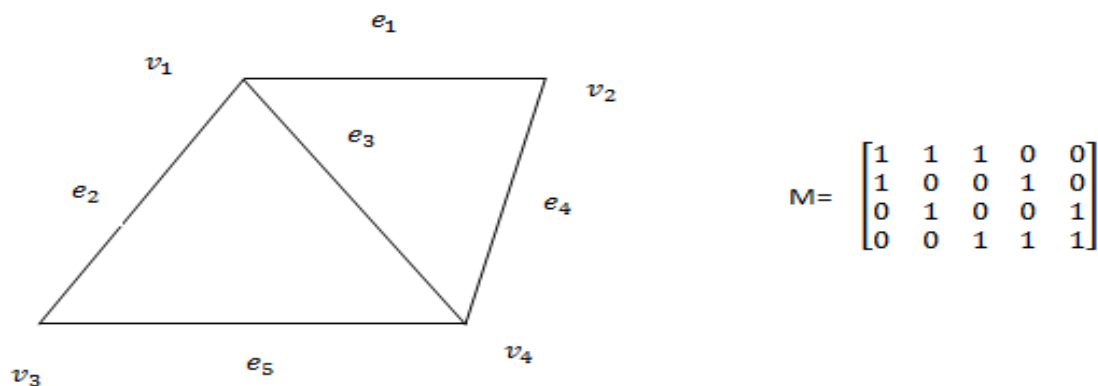

Fig: A graph and its Incidence matrix

International Journal of Innovative Research in Science, Engineering and Technology

(An ISO 3297: 2007 Certified Organization)

Website: www.ijirset.com

Vol. 6, Issue 1, January 2017

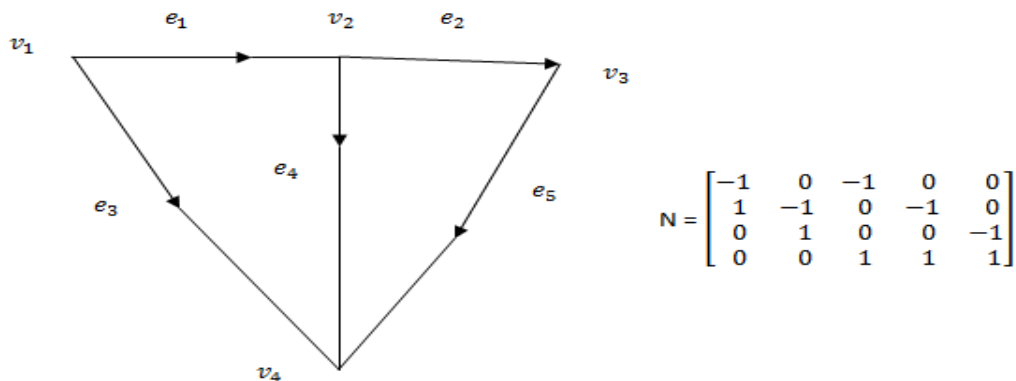

Fig: A graph and its directed incidence matrix

3) Fundamental Tie set matrix (Fundamental loop matrix):

This matrix is associated to a fundamental loop i.e. a loop formed by only one link (branch that does not belong to a particular tree) associated with other twigs (branch of trees). Here we assume that the direction of loop currents and direction of the link is same.

So in the matrix

$b_{ij} = 1$, if the branch b_j in the fundamental loop i and their reference direction oriented same

$b_{ij} = -1$ if the branch b_j in the fundamental loop i and their reference direction oriented opposite

$b_{ij} = 0$ if the branch b_j is not in the fundamental loop i

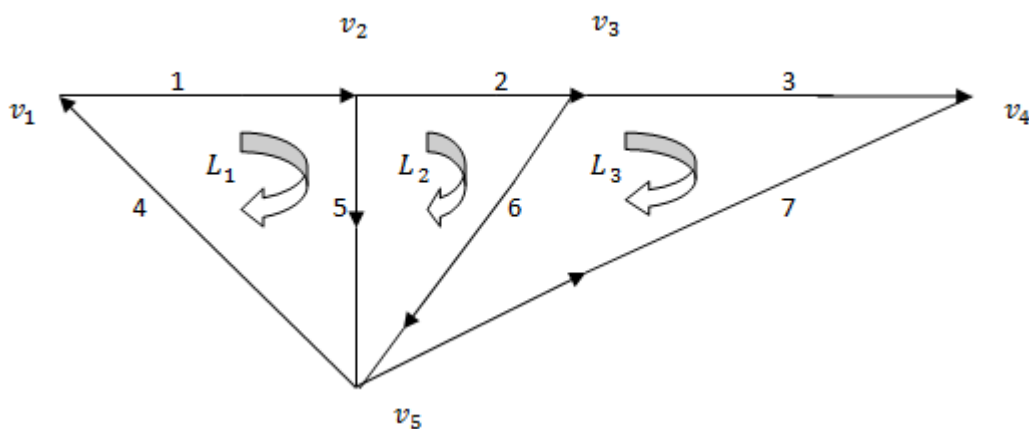

Here, we consider three loops. L_1 consists of branches 1, 5, 4, L_2 consist of branches 2, 5, 6

L_3 Consists of branches 3, 6, 7. Direction of all the loops is taken anticlockwise. So in the matrix where loops are along the rows and branches are along the columns is given by

$$[B] = \begin{bmatrix} 1 & 0 & 0 & 1 & 1 & 0 & 0 \\ 0 & 1 & 0 & 0 & -1 & 1 & 0 \\ 0 & 0 & 1 & 0 & 0 & -1 & -1 \end{bmatrix}$$

International Journal of Innovative Research in Science, Engineering and Technology

(An ISO 3297: 2007 Certified Organization)

Website: www.ijirset.com

Vol. 6, Issue 1, January 2017

4) Branch Impedance matrix $[Z_b]$:

It is a square matrix of order m where m is the no of branches having branch impedance as the diagonal elements and mutual impedance as off diagonal elements. If there is no transformer or mutual sharing then off diagonal entries are zero.

Thevenin's theorem for equivalent circuits:

Any two terminal bilateral linear d.c.circuits can be replaced by an equivalent circuit consisting of a voltage source and a series resistor.

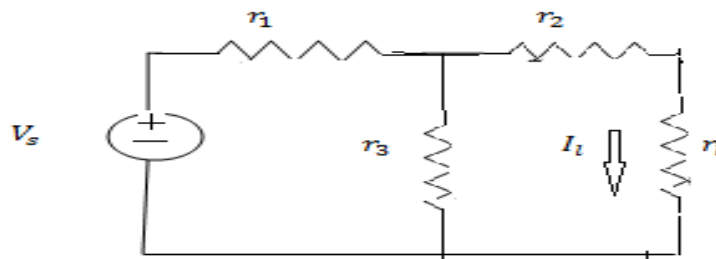

We will find equivalent current by Thevenin's theorem

Here, $I = \frac{V_s}{r_1+r_3}$

Thevenin's equivalent voltage is obtained by removing r_L where $V_{o.c} = I r_3$

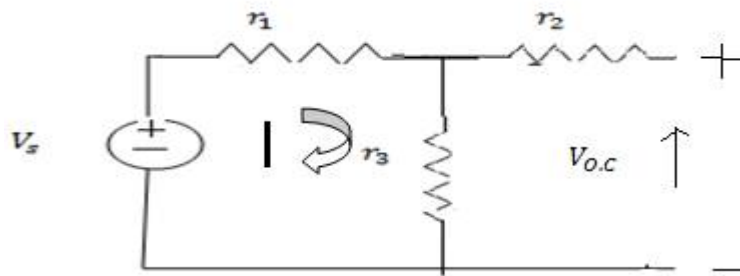

Thevenin's resistance or equivalence resistance is given by $R_{Th} = \frac{r_1 r_3}{r_1+r_3}$

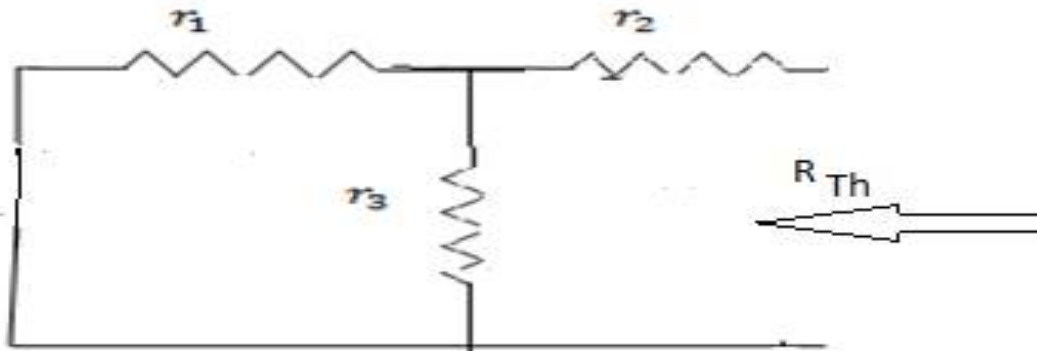

International Journal of Innovative Research in Science, Engineering and Technology

(An ISO 3297: 2007 Certified Organization)

Website: www.ijirset.com

Vol. 6, Issue 1, January 2017

Then the equivalent circuit is given by

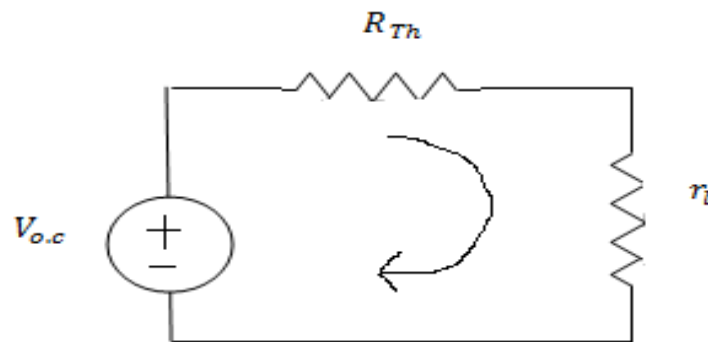

III. APPLICATION OF GRAPH THEORY IN NETWORK EQUILIBRIUM EQUATIONS

Let a voltage V_{sk} be in branch k having impedance z_k and carrying current i_k , we can write $v_k = z_k i_k + V_{sk}$. In matrix form this can be written as $[V_b] = [Z_b][I_b] + [V_s]$ where $[Z_b]$ is the branch impedance matrix, $[I_b]$ is the column vector of branch currents and $[V_s]$ is the column vector of source voltage. Now Kirchhoff's Voltage law in matrix form is given by

$$\begin{aligned} [B][V_b] &= 0 \\ \Rightarrow [B]\{[Z_b][I_b] + [V_s]\} &= 0 \\ \Rightarrow [B][Z_b][I_b] &= -[B][V_s] \end{aligned}$$

Also we know that $[I_b] = [B^t][I_L]$ where $[I_L]$ is the loop current and $[B^t]$ is the transpose of $[B]$. So we get $[B][Z_b][B^t][I_L] = -[B][V_s]$

We will perform this equation to analyze the following circuits and also in the equivalent circuits obtained by Thevenin's theorems

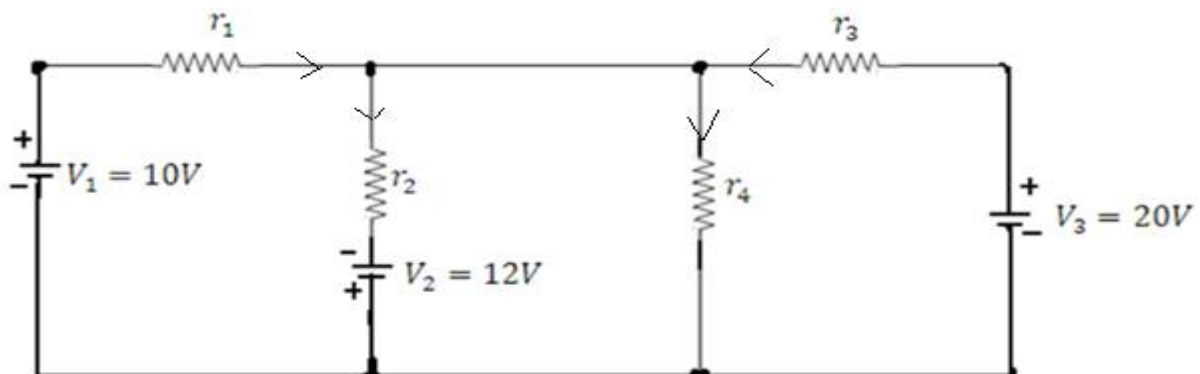

The values of $v_1 = 10V$, $v_2 = 12V$, $v_3 = 20V$ and values of $r_1 = 2\Omega$, $r_2 = 5\Omega$, $r_3 = 1\Omega$, $r_4 = 10\Omega$. The graph obtained from the circuit is

International Journal of Innovative Research in Science, Engineering and Technology

(An ISO 3297: 2007 Certified Organization)

Website: www.ijirset.com

Vol. 6, Issue 1, January 2017

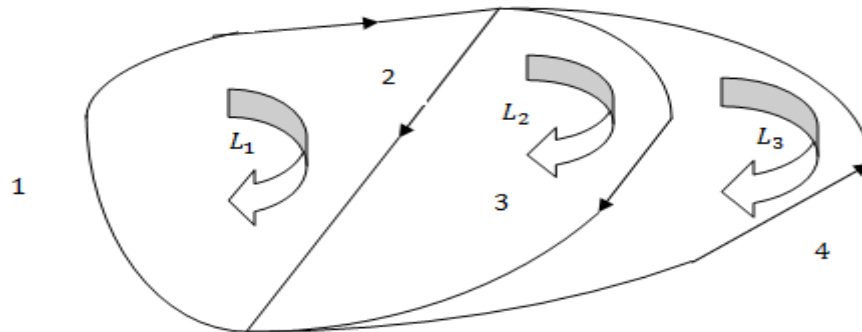

$$\text{Here } [B] = \begin{bmatrix} 1 & 1 & 0 & 0 \\ 0 & -1 & 1 & 0 \\ 0 & 0 & -1 & -1 \end{bmatrix} [Z_b] = \begin{bmatrix} 2 & 0 & 0 & 0 \\ 0 & 5 & 0 & 0 \\ 0 & 0 & 1 & 0 \\ 0 & 0 & 0 & 10 \end{bmatrix} [V_s] = \begin{bmatrix} 10 \\ 12 \\ 0 \\ 20 \end{bmatrix} [I_L] = \begin{bmatrix} L_1 \\ L_2 \\ L_3 \end{bmatrix}$$

$$[B^t] = \begin{bmatrix} 1 & 0 & 0 \\ 1 & -1 & 0 \\ 0 & 1 & -1 \\ 0 & 0 & -1 \end{bmatrix}$$

$$\text{Hence } [B][Z_b][B^t][I_L] = -[B][V_s]$$

$$\Rightarrow \begin{bmatrix} 1 & 1 & 0 & 0 \\ 0 & -1 & 1 & 0 \\ 0 & 0 & -1 & -1 \end{bmatrix} \begin{bmatrix} 2 & 0 & 0 & 0 \\ 0 & 5 & 0 & 0 \\ 0 & 0 & 1 & 0 \\ 0 & 0 & 0 & 10 \end{bmatrix} \begin{bmatrix} 1 & 0 & 0 \\ 1 & -1 & 0 \\ 0 & 1 & -1 \\ 0 & 0 & -1 \end{bmatrix} \begin{bmatrix} L_1 \\ L_2 \\ L_3 \end{bmatrix} = - \begin{bmatrix} 1 & 1 & 0 & 0 \\ 0 & -1 & 1 & 0 \\ 0 & 0 & -1 & -1 \end{bmatrix} \begin{bmatrix} 10 \\ 12 \\ 0 \\ 20 \end{bmatrix}$$

$$\Rightarrow \begin{bmatrix} 2 & 5 & 0 & 0 \\ 0 & -5 & 1 & 0 \\ 0 & 0 & -1 & -10 \end{bmatrix} \begin{bmatrix} 1 & 0 & 0 \\ 1 & -1 & 0 \\ 0 & 1 & -1 \\ 0 & 0 & -1 \end{bmatrix} \begin{bmatrix} L_1 \\ L_2 \\ L_3 \end{bmatrix} = - \begin{bmatrix} 22 \\ -12 \\ -20 \end{bmatrix}$$

$$\Rightarrow \begin{bmatrix} 7 & -5 & 0 \\ -5 & 6 & -1 \\ 0 & -1 & 11 \end{bmatrix} \begin{bmatrix} L_1 \\ L_2 \\ L_3 \end{bmatrix} = - \begin{bmatrix} 22 \\ -12 \\ -20 \end{bmatrix}$$

From this we get

$$L_1 = \frac{-35}{7} A \quad L_2 = \frac{-4}{5} A \quad L_3 = \frac{13}{4} A$$

We shall apply Thevenin's theorems to construct an equivalent circuit of it.

First we remove the resistance r_4 from the circuit. Let the equivalence voltage along the connected nodes be $V_{o,c}$.

International Journal of Innovative Research in Science, Engineering and Technology

(An ISO 3297: 2007 Certified Organization)

Website: www.ijirset.com

Vol. 6, Issue 1, January 2017

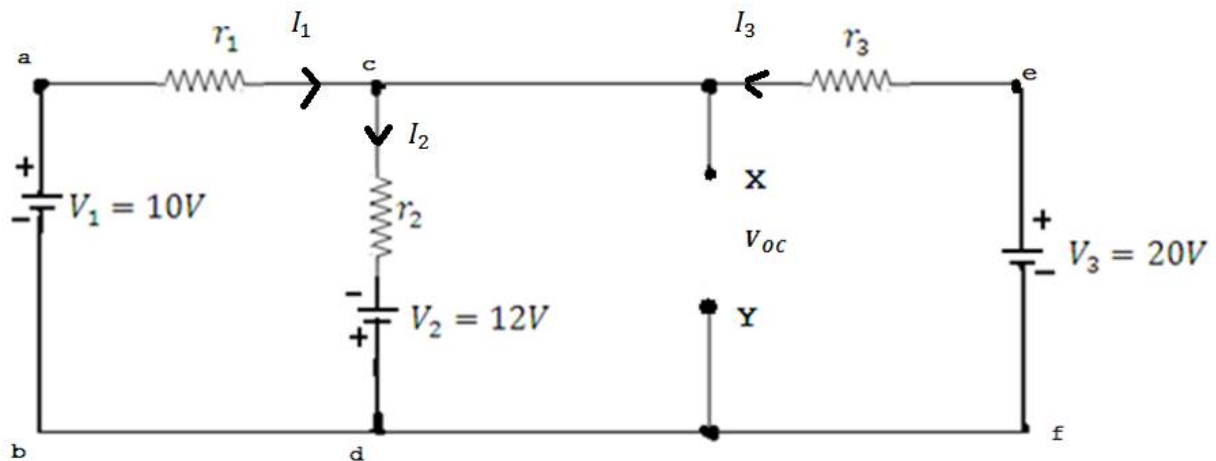

Now applying Kirchoff's current law at node C , we get

$$\begin{aligned}
 I_1 + I_3 - I_2 &= 0 \\
 \Rightarrow \frac{v_1 - V_{o.c}}{r_1} + \frac{v_3 - V_{o.c}}{r_3} - \frac{V_{o.c} + v_2}{r_2} &= 0 \\
 \Rightarrow \frac{10 - V_{o.c}}{2} + \frac{20 - V_{o.c}}{1} - \frac{V_{o.c} + 12}{5} &= 0 \\
 \Rightarrow V_{o.c} &= 13.29 \text{ V}
 \end{aligned}$$

Let the equivalence resistance along the disconnected nodes i.e. along x -- y be R_{Th}

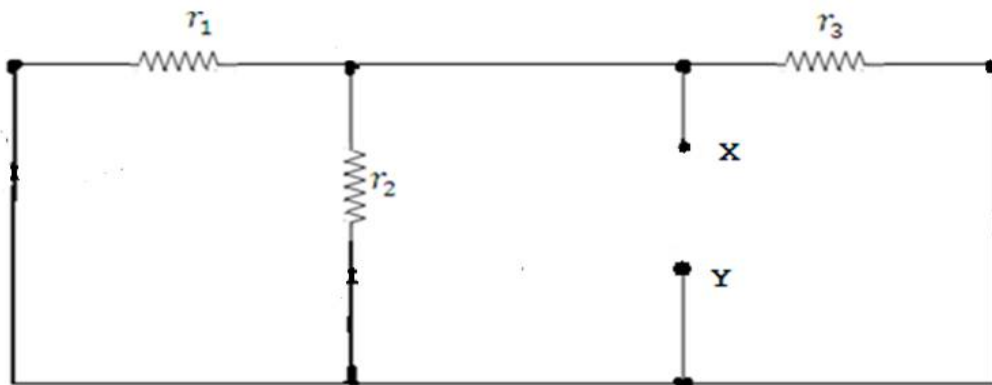

Then applying laws of equivalence resistance

$$\begin{aligned}
 \frac{1}{R_{Th}} &= \frac{1}{r_3} + \frac{1}{r_2} + \frac{1}{r_1} \\
 \Rightarrow \frac{1}{R_{Th}} &= \frac{1}{1} + \frac{1}{5} + \frac{1}{2} \\
 \Rightarrow R_{Th} &= \frac{10}{17} \Omega
 \end{aligned}$$

International Journal of Innovative Research in Science, Engineering and Technology

(An ISO 3297: 2007 Certified Organization)

Website: www.ijirset.com

Vol. 6, Issue 1, January 2017

Hence the Thevenin's equivalent circuit is given by

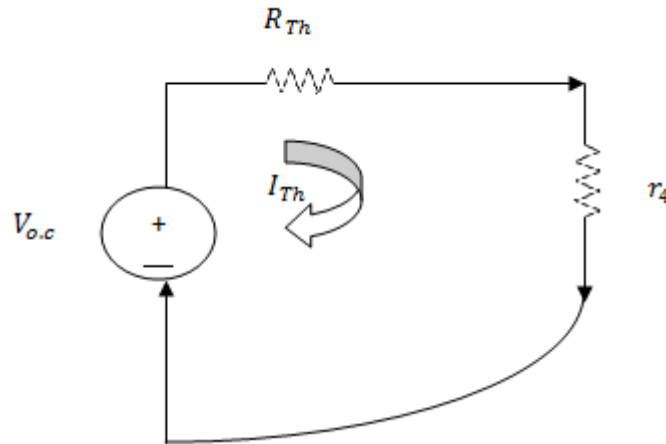

So the values of I_4 (i.e the current through r_4) $I_{Th} = \frac{V_{o.c}}{R_{Th} + r_4}$
 $\Rightarrow I_{Th} = \frac{13.29}{\frac{10}{17} + 10} = 1.26 \text{ A}$

Now we will find the same current I_{Th} by using network equilibrium equation

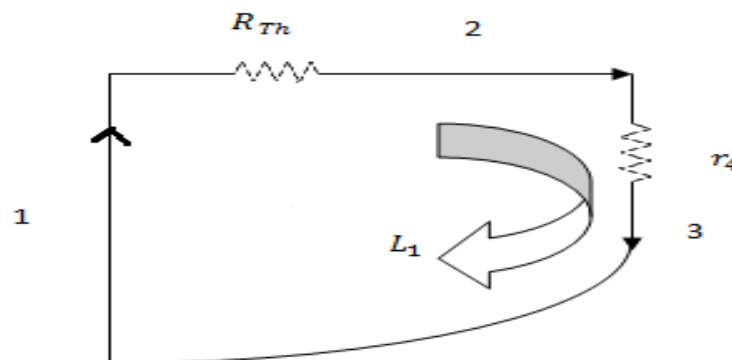

In the reduced circuit

$$[B] = \begin{bmatrix} 1 & 1 & 1 \end{bmatrix} \quad [Z_b] = \begin{bmatrix} 0 & 0 & 0 \\ 0 & \frac{10}{17} & 0 \\ 0 & 0 & 10 \end{bmatrix} \quad [B^t] = \begin{bmatrix} 1 \\ 1 \\ 1 \end{bmatrix} \quad [V_s] = \begin{bmatrix} 13.29 \\ 0 \\ 0 \end{bmatrix} \quad [I_L] = [L_1]$$

$$\text{So, } [B][Z_b][B^t][I_L] = -[B][V_s]$$

$$\Rightarrow \begin{bmatrix} 1 & 1 & 1 \end{bmatrix} \begin{bmatrix} 0 & 0 & 0 \\ 0 & \frac{10}{17} & 0 \\ 0 & 0 & 10 \end{bmatrix} \begin{bmatrix} 1 \\ 1 \\ 1 \end{bmatrix} [L_1] = - \begin{bmatrix} 1 & 1 & 1 \end{bmatrix} \begin{bmatrix} 13.29 \\ 0 \\ 0 \end{bmatrix}$$

$$\Rightarrow \begin{bmatrix} 0 & \frac{10}{17} & 10 \end{bmatrix} \begin{bmatrix} 1 \\ 1 \\ 1 \end{bmatrix} [L_1] = - [13.29]$$

International Journal of Innovative Research in Science, Engineering and Technology

(An ISO 3297: 2007 Certified Organization)

Website: www.ijirset.com

Vol. 6, Issue 1, January 2017

$$\Rightarrow \left[\frac{10}{17} + 10 \right] [L_1] = - [13.29]$$

$\Rightarrow L_1 = - 1.26 \text{ A}$, which is same as the current obtained by Thevenin's equivalence circuit under general calculation. (Negative sign shows that current is in opposite direction)

IV. CONCLUSION

From the above study, it is observed that the result obtained by Thevenin's theorem is same as the result obtained by graph theoretic approach using network equilibrium equations. Following this concept one can develop the equivalent circuits from the complicated circuits with the help of graph theory.

REFERENCES

- [1] E.R. Van Dam, W.H. Haemers, J.H. Koolen, E. Spence, "Characterizing distance-regularity of graphs by the spectrum", Journal of Combinatorial Theory, Series A 113, pp.1805–1820, 2006.
- [2] Wei Wang, Cheng-Xian Xu, "On the asymptotic behavior of graphs determined by their generalized spectra", Discrete Mathematics, vol. 310, pp. 70-76, 2010
- [3] Xiaoling Zhang, Heping Zhang, "Some graphs determined by their spectra", Linear Algebra and its Applications, Elsevier, vol.431, pp.1443–1454, 2009
- [4] M.A. Fiol, M. Mitjana, "The local spectra of regular line graphs", Discrete Mathematics, Elsevier, vol. 310, pp. 511-517, 2010.
- [5] Anirban Banerjee, Jurgen Jost, "On the spectrum of the normalized graph Laplacian", Linear Algebra and its Applications, Elsevier, vol. 428 pp.3015–3022, 2008
- [6] Dragos Cvetkovic, Slobodan K. Simic, "Towards a spectral theory of graphs based on the signless Laplacian, II", Linear Algebra and its Applications, Elsevier, vol.432, pp. 2257–2272, 2010.
- [7] Abbas Heydari, Bijan Taeri, "On the characteristic polynomial of a special class of graphs and spectra of balanced trees", Linear Algebra and its Applications, vol.429, pp. 1744–1757, 2008.
- [8] Abhijit Chakrabarti, "Circuit Theory Analysis and Synthesis", Dhanpat Rai & Co.
- [9] Ting-Jung Chang, Bit-Shun Tam, "Graphs with maximal signless Laplacian spectral radius", Linear Algebra and its Applications, vol. 432 pp.1708–1733, 2010
- [10] Narsingh Deo, "Graph Theory with Applications to Engineering and Computer Science", Phi Learning Private Limited, New Delhi.