

## International Journal of Innovative Research in Science, Engineering and Technology

(An ISO 3297: 2007 Certified Organization)

Website: [www.ijirset.com](http://www.ijirset.com)

Vol. 6, Issue 6, June 2017

# ANALYSIS OF THE PURE CU AND CU-COMPOSITS FABRICATED BY STIR CASTING METHOD

<sup>1</sup>Rahul Kumar, <sup>2</sup>Prof. Richa Thakur

<sup>1</sup>M. Tech. Scholar, Department of Mechanical Engineering, SORT, People's University, Bhopal, M.P, India

<sup>2</sup>Assistant Professor, Department of Mechanical Engineering, SORT, People's University, Bhopal, M.P, India

**ABSTRACT:** There is strong evidence showing that microstructure and mechanical properties of a cast component can be considerably improved if nanoparticles are used as a reinforcement to form a metal-matrix nanocomposite. In this paper, 6061 nanocomposite castings were fabricated using the ultrasonic stirring technology (UST). The Pure Copper and SiC nanoparticles were used as the matrix alloy and the reinforcement, respectively. Nanoparticles were injected into the molten metal and dispersed by ultrasonic cavitation and acoustic streaming. The applied UST parameters in the current experiments were used to validate a recently developed multiphase computational fluid dynamics (CFD) model, which was used to model the nanoparticle dispersion during UST processing. The CFD model accounts for turbulent fluid flow, heat transfer, and the complex interaction between the molten alloy and nanoparticles using the ANSYS's fluent dense discrete phase model (DDPM). The modeling study includes the effects of ultrasonic probe location and the initial location where the nanoparticles are injected into the molten alloy. The microstructure, mechanical behavior, and mechanical properties of the cast nanocomposites have been also investigated in detail.

**KEYWORDS:** Ultrasonic Stirring Technology (UST), Computational Fluid Dynamics (CFD), Dense Discrete Phase Model (DDPM)

### INTRODUCTION

This study aims at improving mechanical properties of electrical contacts through copper and copper-matrix silicon-carbide reinforced composites produced with powder metallurgy. Copper powder was produced with the cementation method. Pure copper and mixtures of copper with 2% and 4% of mass fraction of SiC powder were pressed with uniaxial pressure of 280MPa and sintered at 700 °C for 2 h in an atmospheric environment. After the sintering, these compacts were immediately pressed at a load of 850MPa while the samples were hot. The characterization of the samples was made with microstructural investigations, relative-density experiments, electrical-conductivity and hardness measurements. XRD analyses revealed that there are no other phases besides Cu and SiC in the sintered samples.

The loss of the contact material increased with the increasing number of turn-ons, related with the increased copper oxide amount formed on the contact surfaces.

Aluminum matrix composites have the potential to offer desirable properties, including low density, high specific strength, high specific stiffness, excellent wear resistance, and controllable expansion coefficient, which make them attractive for numerous applications in aerospace, automobile, and military industries. It is a promising approach to use nano-sized ceramic particles to strengthen metal-matrix nanocomposites (MMNCs), while maintaining good ductility. Currently, there are several fabrication methods of MMNCs, including mechanical alloying with high energy milling, ball milling, nano-sintering, spray deposition. The mixing of nano-sized ceramic particles is normally lengthy, expensive, and energy consuming. Several recent studies revealed that ultrasonic cavitation processing is highly efficient in dispersing nanoparticles. Ultrasonic effects on the microstructure of alloys are multi-faceted and include reduction in the grain size, control of columnar structure, formation of equiaxed grains, improvement of material homogeneity, segregation control, and the uniform distribution of second phases and inclusions. Although many studies of the use of ultrasonic energy during solidification have been carried out in the laboratory, there has been limited industrial scale application. In addition, there have been no fundamental studies on the effects of ultrasonic vibration on the nucleation and growth of grains during solidification. The project team identified an opportunity to improve energy efficiency by evaluating the core principles and establishing quantitative bases for the ultrasonic processing of

# International Journal of Innovative Research in Science, Engineering and Technology

(An ISO 3297: 2007 Certified Organization)

Website: [www.ijirset.com](http://www.ijirset.com)

Vol. 6, Issue 6, June 2017

materials. The project team demonstrated key applications in the areas of grain refinement of alloys during solidification and degassing of alloy melts. The results demonstrated that ultrasonic processing can be used to produce spherical grains that are smaller than those produced with the most powerful grain refiners. Furthermore, materials with these spherical grains are suitable for semisolid metal processing, a new processing technology for producing high-quality components for critical applications. The experimental results suggest that ultrasonic processing has the potential for a more energy-efficient scale up for the production of critical metal components, leading to cost reductions, energy savings, and many other benefits. Aluminium based metal matrix composites have been one of the key research areas in materials processing field in the last few decades. Most of the research work has been dealing with aluminium matrix and SiC reinforcement requiring the light weight in combination of high strength and high stiffness. This is because aluminium is lighter weight which is first requirement in most of the industries. In additionally, it provides impressive strength improvement and the thermal expansion coefficient of Al matrix composites can be adjusted by using silicon carbide, pure copper and cu-composites. As a result, these materials are now being rapidly utilized in industries that traditionally used metals.

## I. LITERATURE REVIEW

**Shian Jia, Daojie Zhang and Laurentiu Nastac, “Experimental and Numerical Analysis of the 6061-Based Nanocomposites Fabricated via Ultrasonic Processing” (2015)**, there is strong evidence showing that microstructure and mechanical properties of a cast component can be considerably improved if nanoparticles are used as a reinforcement to form a metal-matrix nanocomposite. In this paper, 6061 nanocomposite castings were fabricated using the ultrasonic stirring technology (UST). The 6061 alloy and Al<sub>2</sub>O<sub>3</sub>/SiC nanoparticles were used as the matrix alloy and the reinforcement, respectively. Nanoparticles were injected into the molten metal and dispersed by ultrasonic cavitation and acoustic streaming. The applied UST parameters in the current experiments were used to validate a recently developed multiphase computational fluid dynamics (CFD) model, which was used to model the nanoparticle dispersion during UST processing. The CFD model accounts for turbulent fluid flow, heat transfer, and the complex interaction between the molten alloy and nanoparticles using the ANSYS\_s fluent dense discrete phase model (DDPM). The modeling study includes the effects of ultrasonic probe location and the initial location where the nanoparticles are injected into the molten alloy. The microstructure, mechanical behavior, and mechanical properties of the cast nanocomposites have been also investigated in detail. The current experimental results showed that the tensile strength of the as-cast-reinforced 6061 alloy with Al<sub>2</sub>O<sub>3</sub> or SiC nanoparticles increased slightly while the elongation increased significantly. The addition of the Al<sub>2</sub>O<sub>3</sub> or SiC nanoparticles in 6061 alloy matrix changed the fracture mechanism from brittle dominated to ductile dominated.

**Hemendra Kumar Srivastva, Arurendra Singh Chauhan, Manmohan Kushwaha, Amaan Raza, Prashant kr Bhardwaj and Vaibhav Raj, “Comparative Study of Different Materials with Al-Sic for Engine Valve Guide by Using FEM” (2016)**, in this work, an effort has been designed to raise the reliability of engine using Al-Sic composites with other alternatively materials for the engine valve guides. Aluminum matrix composites have found the most suitable inside automotive, aerospace and aircraft industries and contain the greatest promise for future year's growth. The finite element analysis of the Al-Sic composite with Titanium alloy (Ti-834), Copper Nickel Silicon alloys (CuNi3Si), and aluminum bronze alloy as an alternative material for engine valve guide was done using Ansys 13.0 software. The stress analysis of engine valve guide under the different pressure and temperature is considered, the pressure is taken as from 10 MPa to 100 MPa with different temperatures varying from 600°C to 650°C. The temperature, principal stress and principal strain distribution on the entire surface area of the engine valve guide were obtained. The stresses were observed to be well below the permitted stress for all the materials but the Al-Sic composites found the most suitable one. Valve guide is modeled in pro-engineer software and analysis is carried out in Ansys 13.0. The deformations and stresses induced due to structural and thermal loading is illustrated and discussed.

**G. G. Sozhamannan, S. Balasivanandha Prabu and V. S. K. Venkatagalapathy, “Effect of Processing Paramters on Metal Matrix Composites: Stir Casting Process” (2011)**, conventional stir casting process has been employed for producing discontinuous particle reinforced metal matrix composites for decades. The major problem of this process is to obtain sufficient wetting of particle by liquid metal and to get a homogenous dispersion of the ceramic particles. In the present study, aluminium metal matrix composites were fabricated by different processing temperatures with

# International Journal of Innovative Research in Science, Engineering and Technology

(An ISO 3297: 2007 Certified Organization)

Website: [www.ijirset.com](http://www.ijirset.com)

Vol. 6, Issue 6, June 2017

different holding time to understand the influence of process parameters on the distribution of particle in the matrix and the resultant mechanical properties. The distribution is examined by microstructure analysis, hardness distribution and density distribution.

**Jitendra Kumar, Vicky Kumar, Sunil Kumar and Sandeep, “Development and Investigations of Copper Metal Matrix Composites Reinforced with Graphite” (2016)**, sliding wear is a key determinant of the performance of electrical sliding contacts used in electrical machines. The behaviour of the contacts in sliding couple is controlled by the mutual metal transfer, friction and wear. The present work focuses on evaluation of Tribological performance of copper-graphite composites. Copper-graphite composites of graphite contents of 5 wt. %, 10 wt. % and 15 wt. % made by stir casting route. The wear testing was carried out using pin-on-disk tribometer. . Extensive metallographic investigations were carried out using Scanning Electron Microscope to study the structural changes at the surface and sub-surface of each tested pin. It was found that the investigated materials showed three distinct wear rate regimes: low, mild and severe. The addition of graphite particles simultaneously decreased the wear rates of the composite and the counterpart disk. The wear mechanisms of pure copper at each wear rate regime were believed to be oxidation-delamination, delamination, and seizure wear mechanism, whereas the involved wear mechanisms of either composites were the same, and they were: oxidative-dominant, strain-induced delamination, and sub-surface delamination.

**Mehsana, “A Review on Investigation of Copper Matrix Composite by using Stir casting Method” (2015)**, the “composite material” is composed of a discrete reinforcement & distributed in a continuous phase of matrix, In Copper matrix composite (CMC) one constitutes is Cu which forms network i.e. matrix phase and another constitute serve as reinforcement which is generally ceramic or non-metallic hard material. The basic reason of metals reinforced with hard ceramic particles or fibers are improved properties than its original material like strength, stiffness etc. Stir casting process is mainly used for manufacturing of particulate reinforced metal matrix composite (PMMC). Manufacturing of Cu alloy based casting composite by stir casting is one of the most economical methods of processing MMC. Properties of these materials depend upon many processing parameters and selection of matrix and reinforcements. This paper presents an overview of stir casting process, process parameter, & preparation of CMC material by using Cu as matrix form and TiB<sub>2</sub> as reinforcement.

## II. PROPOSED METHODOLOGY

This chapter focuses on the principles of Computational Fluid Dynamics (CFD), flow phenomena in porous media, and mathematical models for water vapour and heat transfer processes in adsorbent bed used in adsorption cooling system. Five areas of relevant literature were reviewed: (a) general modelling methodology; (b) basic principles of CFD; (c) porous media approach; (d) modelling of water vapour; (e) modelling of heat transfer in adsorbent beds.

- (a) Fluid Flow (Fluent).
- (b) Geometry
- (c) Meshing
- (d) Setup
- (e) Solution
- (f) Results

### (a) Fluid Flow (Fluent)

In this step, you will start ANSYS Workbench, create a new fluent fluid flow analysis system, then review the list of files generated by ANSYS Workbench.

Start ANSYS Workbench by clicking the Windows **Start** menu, then selecting the **Workbench 16.0** option in the **ANSYS 16.0** program group.

**Start → All Programs → ANSYS 16.0 → Workbench 16.0**

## International Journal of Innovative Research in Science, Engineering and Technology

(An ISO 3297: 2007 Certified Organization)

Website: [www.ijirset.com](http://www.ijirset.com)

Vol. 6, Issue 6, June 2017

This displays the ANSYS Workbench application window, which has the **Toolbox** on the left and the **Project Schematic** to its right. Various supported applications are listed in the **Toolbox** and the components of the analysis system will be displayed in the **Project Schematic**

2. Create a new Fluent fluid flow analysis system by double-clicking the **Fluid Flow (Fluent)** option under **Analysis Systems** in the **Toolbox**.

You can also drag-and-drop the analysis system into the **Project Schematic**. A green dotted outline indicating a potential location for the new system initially appears in the **Project Schematic**. When you drag the system to one of the outlines, it turns into a red box to indicate the chosen location of the new system.

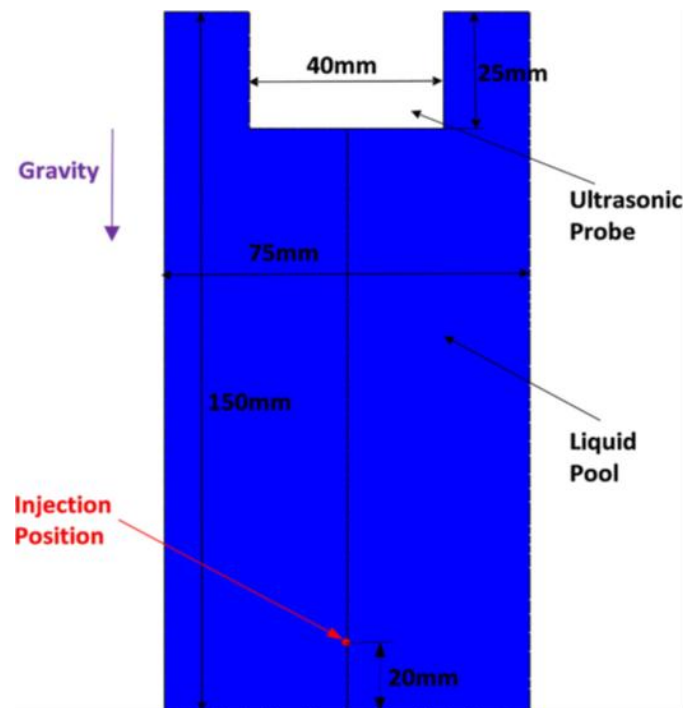

Figure 1: Geometry Model

### (b) Geometry

The geometry of the model is shown in Fig. 2. The ultrasonic probe has a diameter of 40 mm. The Pure copper. It has a density of 8978 kg/m<sup>3</sup> and a viscosity of 1.0 kg/(m s). The SiC nanoparticles with an average particle size of 55 nm and density of 3216 kg/m<sup>3</sup> are treated as inert-particles. The mass flow rate of the SiC nanoparticles is 0.014 kg/s. Thus, 1.0 wt% of SiC nanoparticles can be injected at about 20 mm above the bottom of the furnace for 1.0 s.

# International Journal of Innovative Research in Science, Engineering and Technology

(An ISO 3297: 2007 Certified Organization)

Website: [www.ijirset.com](http://www.ijirset.com)

Vol. 6, Issue 6, June 2017

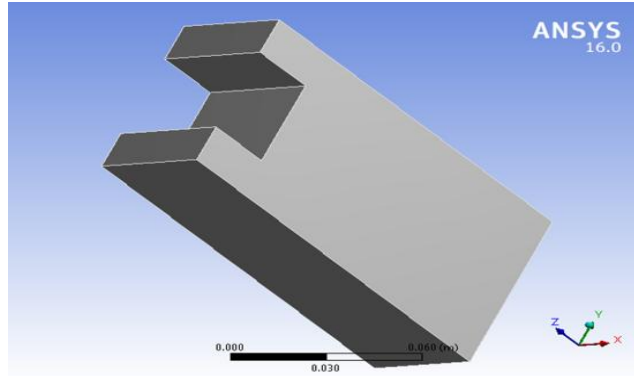

Figure 2: Solid Model of Geometry

The multiphase CFD model accounts for turbulent fluid flow, heat transfer, and the complex interaction between the molten alloy and nanoparticles using the ANSYS\_s Fluent DDPM and j-x turbulence model

### III. SIMULATION RESULT

The multiphase Computational fluid dynamics (CFD) model accounts for turbulent fluid flow, heat transfer, and the complex interaction between the molten alloy and nanoparticles using the ANSYS\_s Fluent DDPM and j-x turbulence model. Shows the mechanical properties of pure copper (100%) is table 1. in this table we are used 8978 kg/m<sup>3</sup> density of pure copper, 381 j/kgk specific heat, 387.6 w/mk thermal conductivity and 1 kg/ms viscosity of pure copper.

Table 1: Mechanical Properties of Pure Copper (100%)

Density	8978 kg/m <sup>3</sup>
C <sub>p</sub> (Specific Heat)	381 j/kgk
Thermal Conductivity	387.6 w/mk
Viscosity	1 kg/ms

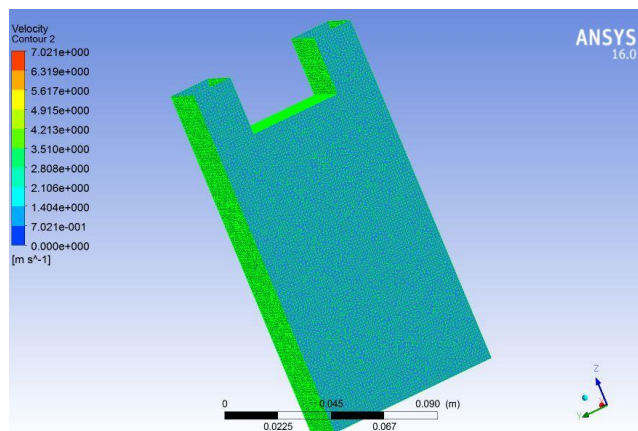

Figure 3: Simulation Result of Contour Velocity of Pure Copper

The simulation result of contour velocity of pure copper is shown in figure 3. In this figure contour velocity is varies between 0.000e+000 m/s to 7.021e+000 m/s.

# International Journal of Innovative Research in Science, Engineering and Technology

(An ISO 3297: 2007 Certified Organization)

Website: [www.ijirset.com](http://www.ijirset.com)

Vol. 6, Issue 6, June 2017

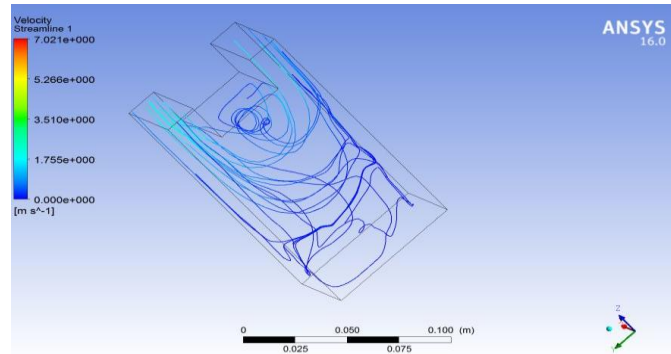

Figure 4: Simulation Result of Stream Velocity of Pure Copper

The simulation result of stream velocity of pure copper is shown in figure 4. In this figure stream velocity is varies between  $0.000e+000$  m/s to  $7.021e+000$  m/s

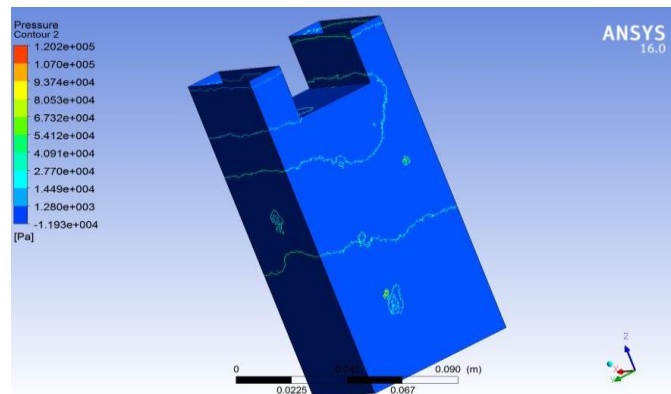

Figure 5: Simulation Result of Pressure of Pure Copper

The simulation result of pressure of pure copper is shown in figure 5. In this figure pressure is varies between  $1.193e+004$  pa to  $1.202e+005$  pa.

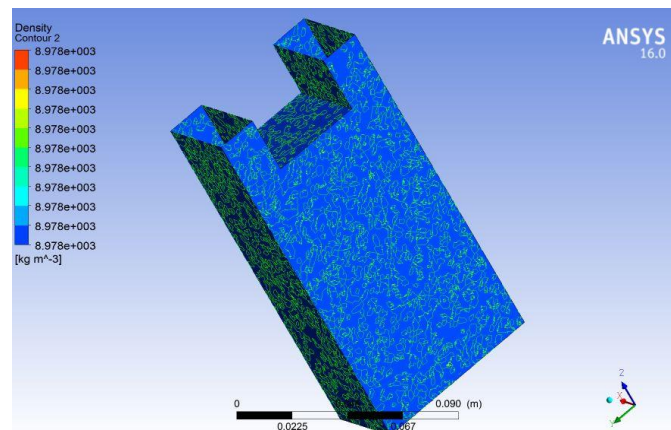

Figure 6: Simulation Result of Density of Pure Copper

# International Journal of Innovative Research in Science, Engineering and Technology

(An ISO 3297: 2007 Certified Organization)

Website: [www.ijirset.com](http://www.ijirset.com)

Vol. 6, Issue 6, June 2017

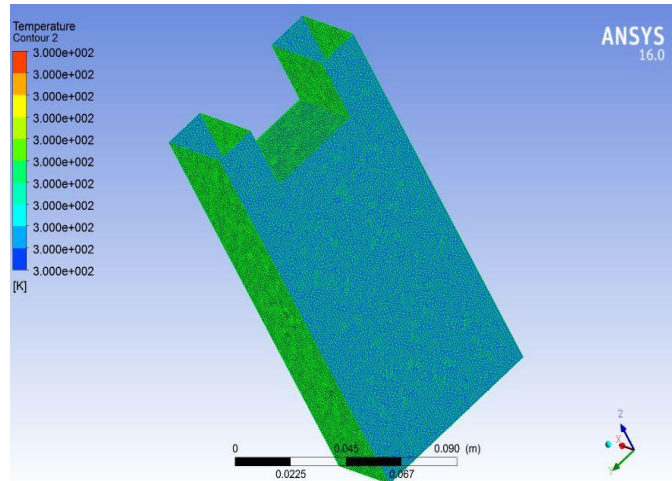

Figure 7: Simulation Result of Density of Pure Copper

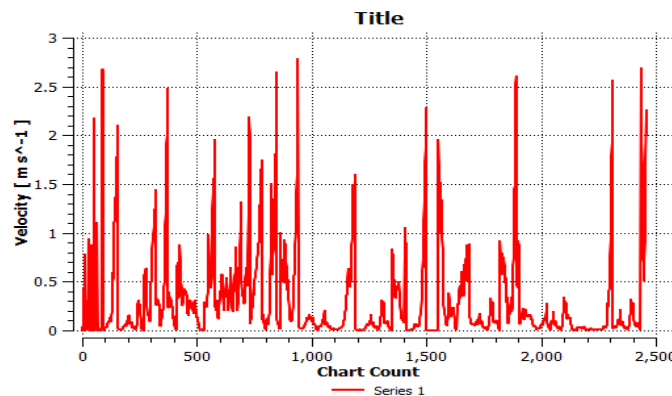

Figure 8: Chart Graph of the Velocity v/s Series

The chart graph of the velocity v/s series is shown in figure 8. It is clearly that the increase the series of the number it is also increase velocity of pure copper.

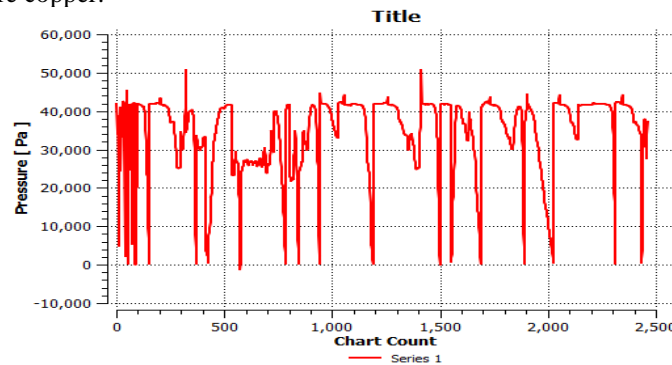

Figure 9: Chart Graph of the Pressure v/s Series

The chart graph of the pressure v/s series is shown in figure 9. It is clearly that the increase the series of the number it is varies of the pressure of pure copper.

# International Journal of Innovative Research in Science, Engineering and Technology

(An ISO 3297: 2007 Certified Organization)

Website: [www.ijirset.com](http://www.ijirset.com)

Vol. 6, Issue 6, June 2017

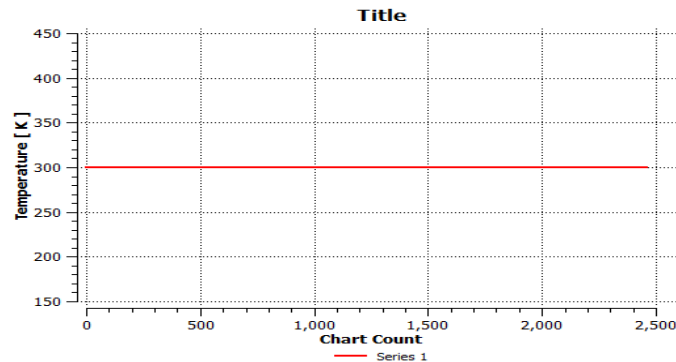

Figure 10: Chart Graph of the Temperature v/s Series

The multiphase Computational fluid dynamics (CFD) model accounts for turbulent fluid flow, heat transfer, and the complex interaction between the molten alloy and nanoparticles using the ANSYS\_s Fluent DDPM and j-x turbulence model. Shows the mechanical properties of pure copper (100%) is table 5.1. in this table we are used 8978 kg/m<sup>3</sup> density of pure copper, 381 j/kgk specific heat, 387.6 w/mk thermal conductivity and 1 kg/ms viscosity of pure copper.

## IV. CONCLUSION

The dry sliding wear behavior of AA6061/AlNp composite was evaluated using the pin-on-disc apparatus. Four factors, five level central composite rotatable design matrix was used to conduct the experiments. To predict the wear rate of AA6061/0-20 wt. % AlNp composite, regression model was developed by incorporating significant parameters such as sliding velocity, sliding distance, normal load and percentage of AlNp reinforcement in the matrix. Conformity tests were conducted to validate the developed regression model. It was found that the accuracy of the prediction of wear rate of AA6061/AlNp composite was within  $\pm 6\%$  of their experimental values. Wear rate of the composite linearly increased with increase in sliding velocity, sliding distance and normal load. Wear rate of the composite decreased with increase in amount of AlNp reinforcement. The wear rate of AA6061 alloy and AA6061 matrix composite reinforced with 10 and 20 wt. % of AlNp were  $722 \times 10^{-5}$  mm<sup>3</sup>/m,  $411 \times 10^{-5}$  mm<sup>3</sup>/m and  $232 \times 10^{-5}$  mm<sup>3</sup>/m respectively.

## REFERENCES

- [1] Shian Jia, Daojie Zhang, and Laurentiu Nastac, "Experimental and Numerical Analysis of the 6061 -Based Nanocomposites Fabricated via Ultrasonic Processing", *Journal of Materials Engineering and Performance*, February 27, 2015.
- [2] Acilar, M & Gul, F 2004, "Effect of the applied load, sliding distance and oxidation on the dry sliding wear behaviour of Al 10Si/SiCp composites 25, no. 3, pp. 209-217.
- [3] Adamowski, J & Szkodo, M 2007, Friction Stir Welds (FSW) of aluminium alloy AA6082-T6, *Journal of Achievements in Materials and Manufacturing Engineering*, vol. 20, pp. 403-406.
- [4] Al-Hamdan, A 2002, Effect of the holding temperature on the solidification processing of cast Al Mg Al<sub>2</sub>O<sub>3</sub> composites, *Materials and Manufacturing Processes*, vol. 17, no. 6, pp. 843-854.
- [5] P. J. Ward, H. V. Atkinson, P. R. G. Anderson, L. G. Elias, B. Garcia, L. Kahlen and J-M. Rodriguez-Ibabe, "Semi-solid processing of novel MMCs based on hypereutectic aluminium-silicon alloys" *Acta Materialia*, Vol. 44, No. 5, 1996, pp.1717-1727.
- [6] C. M. Ward-Close, L. Chandrasekaran, J. G. Robertson, S. P. Godfrey and D. P. Murgatroyde, "Advances in the fabrication of titanium metal matrix composite", *Materials Science and Engineering A*, Vol. 263, No. 2, 1999, pp. 314-318.
- [7] Yoshiaki Shimizu, Toshiyasu Nishimura and Iwao Matsushima, "Corrosion resistance of Al-based metal matrix composites", *Materials Science and Engineering A*, Vol. 198, No.1-2, 1995, pp.113-118.
- [8] C. Chen and F. Mansfeld, "Corrosion protection of an Al 6092/SiCp metal matrix composite", *Journal Corrosion Science*, Vol.39, No.6, 1997, pp.1075-1082.
- [9] D. J. Blackwood, A. W. C. Chua, K. H. W. Seah, R. Thampuran and S. H. Teoh , "Corrosion behaviour of porous titanium-graphite composites designed for surgical implants", *Corrosion Science*, Vol. 42, No.3, 2000, pp. 481-503.
- [10] F. E. Kennedy, A. C. Balbahadur and D. S. Lashmore "The friction and wear of Cu-based silicon carbide particulate metal matrix composites for brake applications", *Wear*, Vol. 203-204, 1997, pp.715-721.