

## International Journal of Innovative Research in Science, Engineering and Technology

(A High Impact Factor, Monthly, Peer Reviewed Journal)

Visit: [www.ijirset.com](http://www.ijirset.com)

Vol. 7, Special Issue 2, March 2018

# Location and Data Privacy Preservation of a Secondary User in a Wireless Cognitive Networks

Anusha.A<sup>1</sup>, Agalya.A<sup>2</sup>, Dhivya.R<sup>3</sup>, S.Selvakanmani<sup>4</sup>

U.G Students, Dept. of CSE, Velammal Institute of Technology, Chennai, Tamil Nadu, India<sup>1,2,3</sup>

Associate Professor, Dept. of CSE, Velammal Institute of Technology, Chennai, Tamil Nadu, India<sup>4</sup>

**ABSTRACT:** The extant system provides location privacy preserving schemes for cognitive radio networks (CRNs) that protect secondary users (SUs) location privacy while allowing them to preserve their own sensitive details. It contains harness probabilistic set membership data structures to exploit the structured nature of spectrum databases (DBs) and SUs queries. This enables us to create a compact representation of DB that could be queried by SUs without having to share their location with DB, thus guaranteeing their location and data privacy. In our proposed work, the system allows user to register in the Network and allows them to upload any kind of sensitive detail through setting down into it. The system provides security for the data of a secondary user (SU) in a cognitive network through AES encryption algorithm. If any of the intruder in network tries to steal user's details, they will use fake details for setting down. In the mean time, server in the network is warned about cybercriminal entering and it tracks IP address, ISP and geographical information of the Intruder and blocks Invader from entering within the network.

**KEYWORDS:** Privacy preservation, Wireless Cognitive Network, Advanced Encryption Standard(Algorithm), LPDBQS(Algorithm), Interloper attack

### I.INTRODUCTION

A **wireless network** is a computer network that uses wireless data connections between network nodes. Wireless networking is a method by which homes, telecommunications networks and business installations avoid the costly process of introducing cables into a building, or as a connection between various equipment locations(Fig.1).

Wireless network classified as :

Wireless PAN(personal area network) Wireless LAN(local area network)

Wireless ad hoc network

wireless MAN (metropolitan area networks) Wireless WAN (wide area networks)

Cellular network

Global area  
network Space  
network

# International Journal of Innovative Research in Science, Engineering and Technology

(A High Impact Factor, Monthly, Peer Reviewed Journal)

Visit: [www.ijirset.com](http://www.ijirset.com)

Vol. 7, Special Issue 2, March 2018



Fig.1. Wireless Network

## Wireless Cognitive Network(WCN):

Cognitive radio is an adaptive, intelligent radio and network technology that can automatically detect available nodes in a wireless spectrum and change transmission parameters enabling more communication to run concurrently. Cognitive Radio Network (CRN) is regarded as an emerging technology to address the increasing demand for node resources. It solves the node resource shortage problem by allowing a Secondary User (SU) to access the channel of a Primary User (PU) when the channel is not occupied by the PU, in which an SU queries a database to obtain node availability information by submitting a location based query(Fig.2).

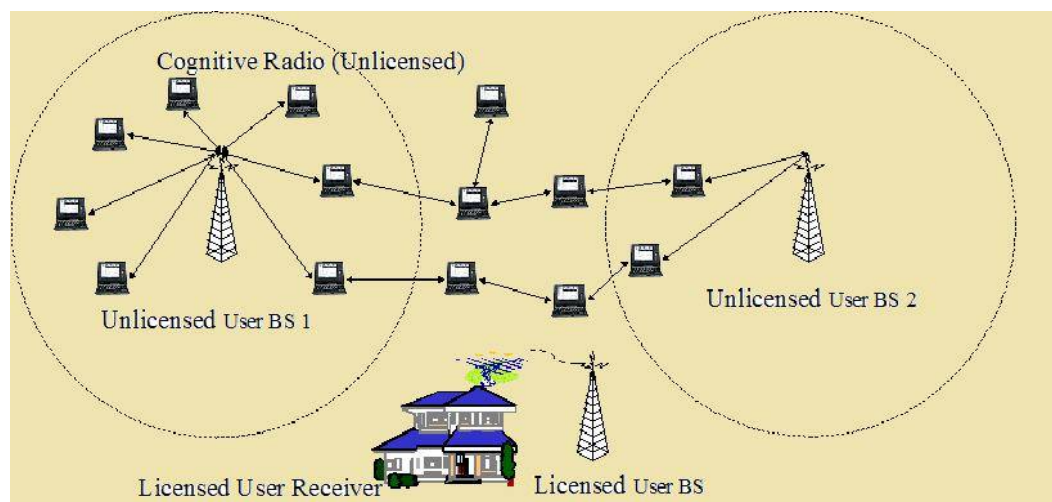

Fig.2. Wireless Cognition Network

**Primary user(PU):** They were the **licensed user** of the network and have the access for their account features.

**Secondary user(SU):** They were the **unlicensed user** of the network .Also known as Mobile users(on travel).

In CRNS, the SUs are allocated with primary user's node for accessing when they are at rest from network. In this case, the data of the SU were visible to PU. For this issue many researches were undertaken and found solutions by introducing two party protocols ,filters such as cuckoo and bloom. Though the security is provided for SUs the intruder's in the network tries to hack the network and steals the data of the users. Security is a major factor that reduces the performance in Wireless Cognition Network(WCN).

# International Journal of Innovative Research in Science, Engineering and Technology

(A High Impact Factor, Monthly, Peer Reviewed Journal)

Visit: [www.ijirset.com](http://www.ijirset.com)

Vol. 7, Special Issue 2, March 2018

However, one concern about database-driven CRNs is that the queries sent by SUs will inevitably leak the location information. Instead of directly learning the SUs' locations from their queries, our discovered attacks can infer an SU's location through his used nodes. The location privacy preservation schemes for database driven cognitive radio networks provides a optimal location privacy to secondary users within database coverage network by leveraging set membership data structure to construct a compact version of database. Even though the location is preserved from Intruder ,they tries to hack the sensitive details of SUs such as Business information, Personal information,Financial information etc,..

This system allows the SUs to store the sensitive details and keep track from hackers.If any hacker tries to hack the network where the SUs work ,the server in the network tracks the Intruder and finds their IP address ISP,Gateway and geological information of the SUs like latitude and longitude value.Finally blocks the Hackers.

## Disadvantages of extant system:

- The location privacy issue in database-driven CRNs.
- It introduces some noise to SU's location which may cause erroneous spectrum availability information

## II.LITERATURE REVIEW

The authors Mohamed Grissa et al. ,in 2017 introduced a system that allows to preserve the location privacy of SUs while performing reliable and efficient spectrum sensing using Cryptographic mechanisms[4].

The researchers S.Selvakanmani et al., in 2017 presented a system that achieves a balance by minimizing interference to licensed users and maximizing the entire system performance providing opportunistic access to number of secondary users such as opportunistic spectrum

sensing and adaptive channel assignment through mathematical analysis and MC-OSACA technique[9].. The experts H. Zhu et al., in 2016 invented Jammer Inference based Jamming Defense (jDefender)

Framework. The main idea of jDefender is inferring the likelihood of a user being a jammer based on the observed jamming events and then utilizing the inferred attack likelihood to enhance the effectiveness of a series of proposed anti-jamming strategies[2].

The researchers Mohamed Grissa ,et al., in 2015 proposed a system that provides an efficient scheme for database-driven CRNs that preserves the location privacy of SU through Cuckoo filter [1].

The experts Xu Zhang,et al., in 2014 provided a comprehensive analysis and guide of existing efforts around localization and location privacy preservation in cognitive radio network.

The cognoscenti Z. Gao,et al., in 2013 designed Private Spectrum Availability Information Retrieval scheme that utilizes a blind factor to hide the location of the SU and proposed a novel prediction based Private Channel Utilization protocol that reduces the possibilities of location privacy leaking by choosing the most stable channels[11].

Despite its importance, the location privacy issue in CRNs only recently gained interest from the research community[4]. Some works focused on addressing this issue in the context of collaborative spectrum sensing [5]–[8],[14]–[15]. Protecting SU s' location privacy in database-driven CRNs is a very challenging task, since SU s are required to provide their physical locations to DB in order for them to be able to learn about spectrum opportunities in their vicinities[1].However, direct adaptation of such concepts yield either insecure or extremely costly results. For instance, k-anonymity guarantees that SU 's location is indistinguishable among a set of k points, which could be achieved through the use of dummy locations by generating k properly selected dummy points, and performing k

# International Journal of Innovative Research in Science, Engineering and Technology

(A High Impact Factor, Monthly, Peer Reviewed Journal)

Visit: [www.ijirset.com](http://www.ijirset.com)

Vol. 7, Special Issue 2, March 2018

queries to DB using both the real and dummy location[16].Their approach makes a tradeoff between providing high location privacy and maximizing some utility, which makes it suffer from the fact that achieving a high location privacy level results in a decrease in spectrum utility. PIR, on the other hand, allows a client to obtain information from a database while preventing the database from learning which data is being retrieved. Several approaches have used this approach[11] proposed a PIR-based approach.

### III.PROPOSED SYSTEM

#### A.System model:

The Cognitive radio network that consists of a set of Secondary users stores geo-location information on the database(DB). SUs are assumed to be enabled with GPS and node sensing capabilities, and to have access to DB to obtain node availability information within its operation locale.The main issue faced by the SUs in CRNs is the state of being free and cybercriminal attacks.The proposed system solves this issues by storing the details of along with location in the database using Encryption algorithms. When the Intruder tries use the SUs details, the presented system immediately notices the IP address,ISP of the Intruder,Gateway and geological informations such as latitude and longitude values.When the server in the CRN knows about the attack as soon as he blocks them.So that the Intruder won't be able to get into that network through that system.

#### B.System Design:

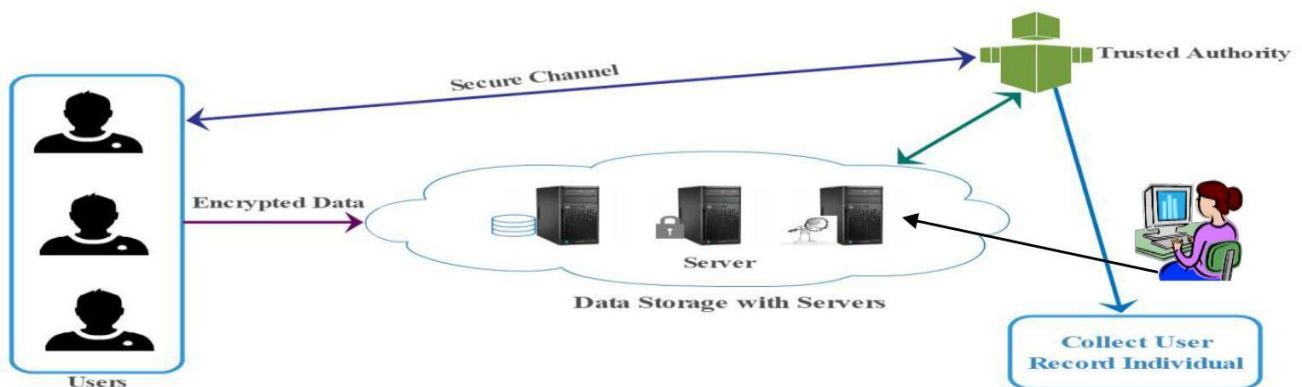

Fig:3 .Overview of extant system

This fig:1. Describes how the authority member provides channels for the SUs and they were using the network by querying the network.The authority member stores the information of the user in a separate database that is visually hidden from the user but abstracted.And also it shows how the Intruder tries to hack the network details.

# International Journal of Innovative Research in Science, Engineering and Technology

(A High Impact Factor, Monthly, Peer Reviewed Journal)

Visit: [www.ijirset.com](http://www.ijirset.com)

Vol. 7, Special Issue 2, March 2018

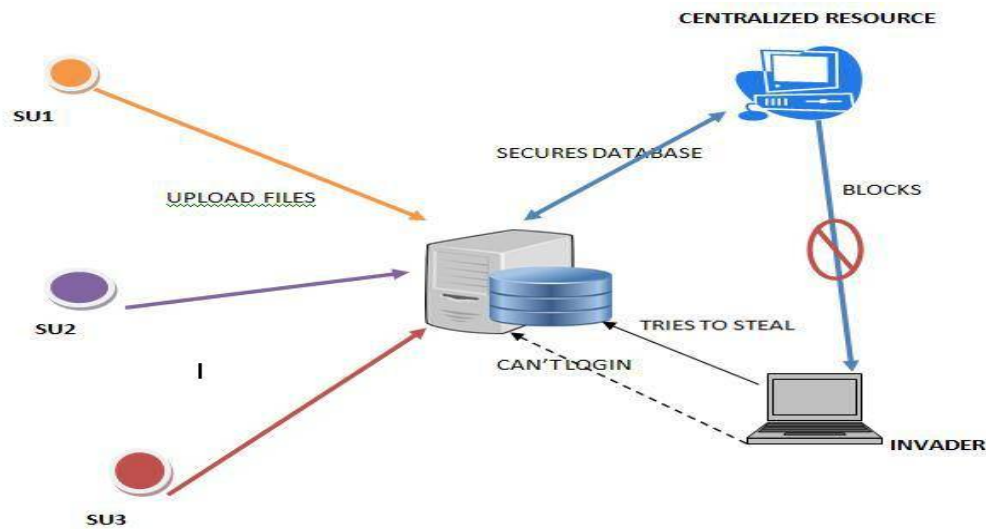

Fig.4: Proposed System

### C.Detailed Description:

- > Network ID Creation and Uploading data.
- > Examine the Intruder and their IP,ISP and Geographical information.
- > Blocking of User

### Network ID creation and Uploading Data

In this , the users in the network registers their own details like user name and password for Network ID registration .This registration will track up location of the secondary user and automatically acquires geo-graphical informations such as latitude and longitude values and send those back to the Centralized resource.

The server of the network allows users to upload file and stores their details in a database. While uploading data of the user in network , the system generates a key for file using Encryption algorithms. If user wants those details for their use, they will be allowed to download files from web at anytime using the key .

### Examine the intruder and their ip,isp and geographical information

If hacker tries to access the network illegally, then they will uses fake user name and password to getin the network.It will show incorrect user name details. In the mean time, the server is warned about malicious

entering inside the network.Then they check details of the interloper.Once they get the details of invader, the centralized person tracks details of invader such as Internet Protocol address,Internet service provider's,Gateway and Geo-graphical information such as latitude and longitude. By referring geographical informations, the server gets their location and also able to view the invader's Location through maps.

# International Journal of Innovative Research in Science, Engineering and Technology

(A High Impact Factor, Monthly, Peer Reviewed Journal)

Visit: [www.ijirset.com](http://www.ijirset.com)

Vol. 7, Special Issue 2, March 2018

## Blocking Of User

In this part of the proposed system, When centralized person realized about malicious activity in network by invader, they identifies the geo-location and network providers of them. Immediately they will block invader system's IP address from network ,so that this people will not be able to setin to the network using their system in anyway.

## D.Algorithm Used:

### 1. LPDBQS(Location Privacy DataBase Query Server)

- 1:SU queries DB with query  $f(k; \text{char}; \text{ts})$ ;
- 2: DB retrieves resp containing r entries satisfying char;
- 3: DB constructs CFk;
- 4: for j = 1; : : : r do
- 5: if avl j = 1 then
- 6:  $x_j (\text{locX jklocY jktsk} : : : \text{krowj}(c))$ ;
- 7: CFk:InsertHMACk (x j);
- 8: DB sends CFk to QS over a high throughput link;
- 9: SU initializes decision Channel is busy
- 10: for all possible combinations of par do
- 11: SU computes  $y (\text{locX klocY kchnktsk} : : : \text{kparn})$ ;
- 12: SU computes  $yk \text{ HMACk}(y)$  and sends it to QS;
- 13: QS looks up for yk in CFk using Lookup;
- 14: if CFk:Lookup(yk) then
- 15: SU senses chn;
- 16: if Sensing(chn) available then
- 17: decision chn is available; break return decision

LPDBQS does not leak any information about SU s' location beyond HMAC secure values. LPDBQS, which offers better performance at SU s' side than that of existing system algorithm. Here the proposed offers better performance at SU s' side than that of LPDB in extant system.This comes at the cost of deploying an additional entity, referred to as query server (QS), and having a computational security as opposed to unconditional. QS is introduced to handle SU s' queries instead of DB itself, which prevents DB from learning information related to SU s' location information. QS learns nothing but secure messages sent by SUs to check the availability of a specific channel.

## STEPS IN LPDBQS:

### STEP 1

SU queries the databse about the availability nodes. The database contents is retrieved as a collection of CF(only the entries that have available channels) by sending a secret key k.

### STEP 2

DB sends CFk to QS over a high throughput link

### STEP 3

SU read about the channel engaging and tries to adapt the idle channel.



# International Journal of Innovative Research in Science, Engineering and Technology

(A High Impact Factor, Monthly, Peer Reviewed Journal)

Visit: [www.ijirset.com](http://www.ijirset.com)

Vol. 7, Special Issue 2, March 2018

## STEP 4

SU hashes  $y$  with the secret key  $k$  and sends the new value  $y_k$  to QS to find out whether CFk of QS contains  $y_k$

## STEP 5

It senses the channel that was included in the query. If the result of the sensing complies with the outcome of the Lookup operation in CFk, then SU can conclude that this channel is available

## STEP 6

DB can pre-compute several cuckoo filters for each possible combination of secret keys  $k$ .

## STEP 7

For spectrum opportunities the DB shares a secret key  $k$  with SU and sends the corresponding CFk to QS, also gets Channel.

## 2. AES:

AES (acronym of Advanced Encryption Standard) is a symmetric encryption algorithm. The algorithm was developed by two Belgian cryptographer Joan Daemen and Vincent Rijmen. AES was designed to be efficient in both hardware and software, and supports a block length of 128 bits and key lengths of 128, 192, and 256 bits

## DESCRIPTION:

1. KeyExpansions $\rightarrow$ round keys are derived from the cipher key using Rijndael's key schedule. AES requires a separate 128-bit round key block for each round plus one more.
2. InitialRound
  - a. AddRoundKey $\rightarrow$ each byte of the state is combined with a block of the round key using bitwise xor.
3. Rounds
  - a. SubBytes $\rightarrow$ a non-linear substitution step where each byte is replaced with another according to a lookup table.
  - b. ShiftRows $\rightarrow$ a transposition step where the last three rows of the state are shifted cyclically a certain number of steps.
  - c. MixColumns $\rightarrow$ a mixing operation which operates on the columns of the state, combining the four bytes in each column.
  - d. AddRoundKey
4. Final Round (no MixColumns)
  - a. SubBytes

# International Journal of Innovative Research in Science, Engineering and Technology

(A High Impact Factor, Monthly, Peer Reviewed Journal)

Visit: [www.ijirset.com](http://www.ijirset.com)

Vol. 7, Special Issue 2, March 2018

- b. ShiftRows
- c. AddRoundKey

## STEPS IN ADVANCED ENCRYPTION STANDARD:

### STEP 1

Derive the set of round keys from the cipher key

### STEP 2

Initialize the state array with the block data

### STEP 3

Add the initial round key to the starting state array

### STEP 4

Perform nine rounds of state manipulation

### STEP 5

Perform the tenth and final round of state manipulation

### STEP 6

Copy the final state array out as the encrypted data

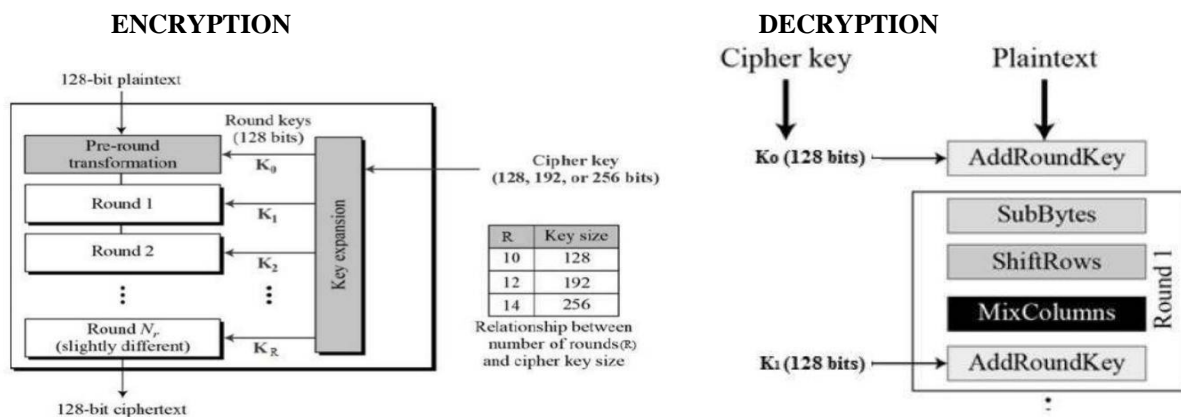



# International Journal of Innovative Research in Science, Engineering and Technology

(A High Impact Factor, Monthly, Peer Reviewed Journal)

Visit: [www.ijirset.com](http://www.ijirset.com)

Vol. 7, Special Issue 2, March 2018

## V.RESULTS

### Performance Evaluation Results

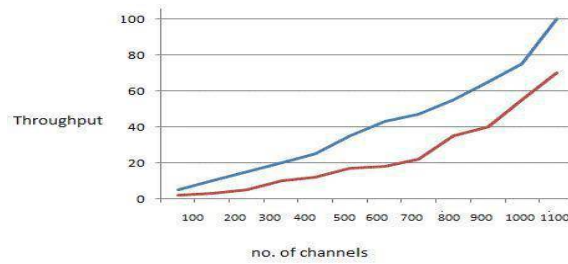

Fig.6.Briefs about performance

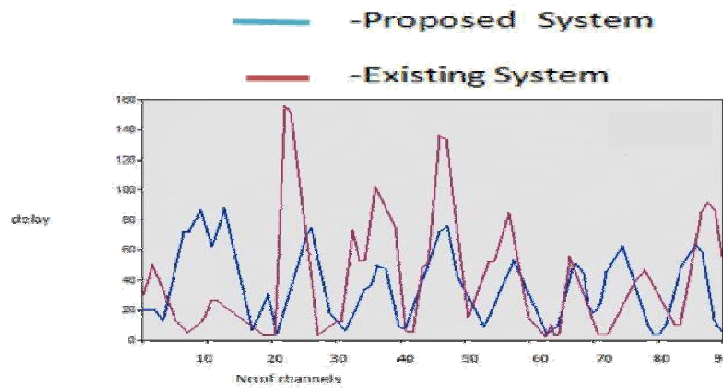

Fig.7.Delay graph

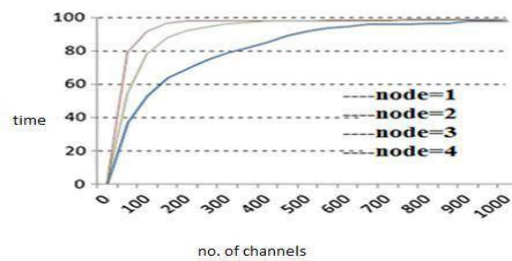

Fig.8. Node Utilisation

# International Journal of Innovative Research in Science, Engineering and Technology

(A High Impact Factor, Monthly, Peer Reviewed Journal)

Visit: [www.ijirset.com](http://www.ijirset.com)

Vol. 7, Special Issue 2, March 2018



REGISTER

NETWORK ID REGISTRATION

Your IP  
0:0:0:0:0:1

Your Computer Name  
DhivyaRajendhran

Choose Your Name  
dhivyar

Choose Your Password  
\*\*\*

Register On Network

Fig.9. describes about registration for user in network using necessary details like name and password.

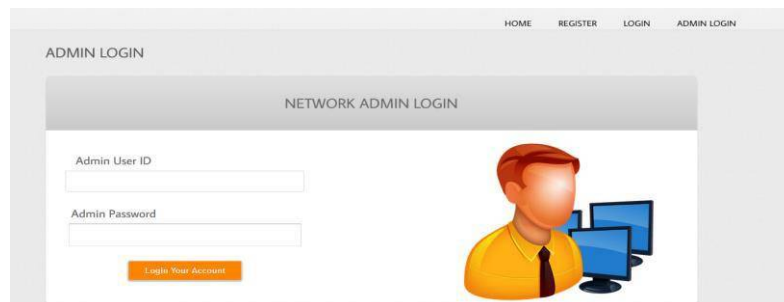

HOME REGISTER LOGIN ADMIN LOGIN

ADMIN LOGIN

NETWORK ADMIN LOGIN

Admin User ID

Admin Password

Login Your Account

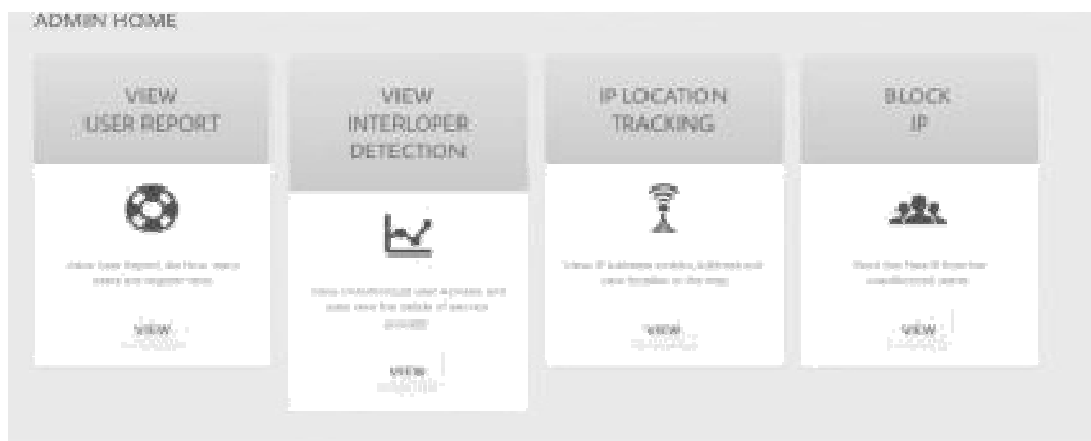

ADMIN HOME

VIEW USER REPORT

VIEW INTERLOPER DETECTION

IP LOCATION TRACKING

BLOCK IP

Fig.10. briefs how the server setin to network and tracks about user entering details and invader's fake details.

# International Journal of Innovative Research in Science, Engineering and Technology

(A High Impact Factor, Monthly, Peer Reviewed Journal)

Visit: [www.ijirset.com](http://www.ijirset.com)

Vol. 7, Special Issue 2, March 2018

GET ATTACKER DETAILS

VIEW NETWORK ATTACKERS

IP	Fake Userid	Fake Password	Attack Time	Details
192.168.225.23	123	abcde	2018/02/22 05:56:16	VIEW DETAILS
192.168.225.23	123	asd	2018/02/22 05:56:57	VIEW DETAILS

Fig.11. shows invader's fake details.

IP ADDRESS LOCATION TRACKING DETAILS

Internet Service Provider	City
AS55836 Reliance Jio Infocomm Limite	Dharapuram
Country	Country Code
India	IN
Latitude	Longitude
13.082680199999999	80.2707184
Gateway	Organization
157.50.222.48	Jio
Region Name	Time Zone
Tamil Nadu	Asia / Kolkata

Fig.12. shows invader's network details.

TRACK ATTACKER LOCATION

VIEW ATTACKER LOCATION ON MAP

IP	latitude Location	longitude Location	Address	View
192.168.225.23	13.082680199999999	80.2707184	GET ADDRESS	VIEW MAP
192.168.225.23	13.082680199999999	80.2707184	GET ADDRESS	VIEW MAP

Fig.13. shows geographical info. of invader.

# International Journal of Innovative Research in Science, Engineering and Technology

(A High Impact Factor, Monthly, Peer Reviewed Journal)

Visit: [www.ijirset.com](http://www.ijirset.com)

Vol. 7, Special Issue 2, March 2018

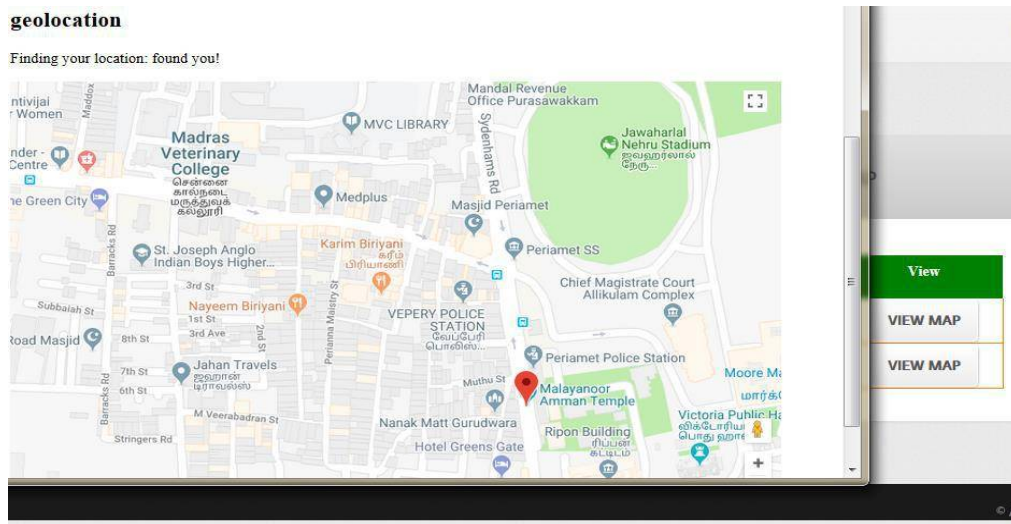

Fig.14. provides a view of exact location of invader.

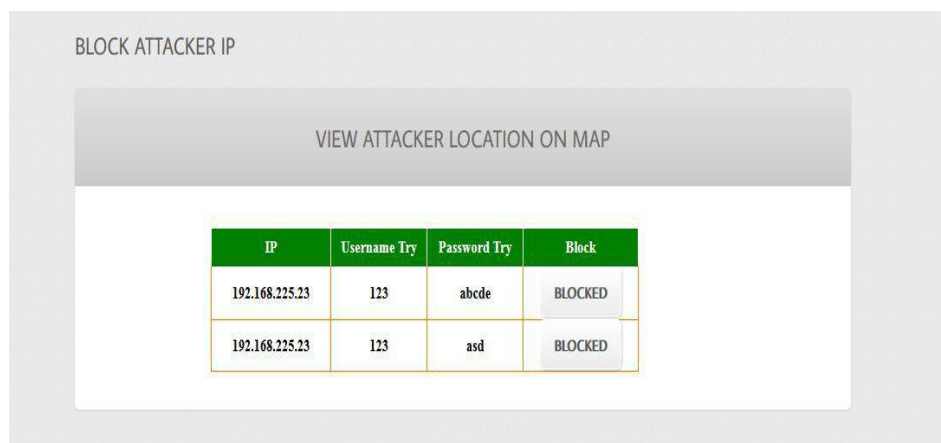

Fig.15. provides a status of invader blocking

## TOOLS DESCRIPTION:

- Front End - HTML, J2EE
- Server side Script - Java Server Pages.
- Database - My sql

Database Connectivity - JDBC.

## Java:

Java technology is both a programming language and a platform.

# International Journal of Innovative Research in Science, Engineering and Technology

*(A High Impact Factor, Monthly, Peer Reviewed Journal)*

Visit: [www.ijirset.com](http://www.ijirset.com)

Vol. 7, Special Issue 2, March 2018

## The Java Programming Language

The Java programming language is a high-level language that can be characterized by all of the following buzzwords:

- Simple
- Architecture neutral
- Object oriented
- Portable
- Distributed
- High performance
- Interpreted
- Multithreaded
- Robust
- Dynamic
- Secure

Java is developed by Sun Microsystems, later acquired by Oracle Corporation, that provides a system for developing application software and deploying it in a cross-platform computing environment. Java is used in a wide variety of computing platforms from embedded devices and mobile phones to enterprise servers and supercomputers. While less common, Java applets run in secure, sand boxed environments to provide many features of native applications and can be embedded in HTML pages.

Writing in the Java programming language is the primary way to produce code that will be deployed as byte code in a Java Virtual Machine (JVM); byte code compilers are also available for other languages, including Ada, JavaScript, Python, and Ruby. In addition, several languages have been designed to run natively on the JVM, including Scala, Clojure and Groovy. Java syntax borrows heavily from C and C++, but object-oriented features are modeled after Smalltalk and Objective-C.[11] Java eschews certain low-level constructs such as pointers and has a very simple memory model where every object is allocated on the heap and all variables of object types are references. Memory management is handled through integrated automatic garbage collection performed by the JVM.

## Back End:

MySQL, the most popular Open Source SQL database management system, is developed, distributed, and supported by Oracle Corporation. The MySQL Web site (<http://www.mysql.com/>) provides the latest information about MySQL software.

## MySQL is a database management system:

A database is a structured collection of data. It may be anything from a simple shopping list to a picture gallery or the vast amounts of information in a corporate network. To add, access, and process data stored in a

## International Journal of Innovative Research in Science, Engineering and Technology

(A High Impact Factor, Monthly, Peer Reviewed Journal)

Visit: [www.ijirset.com](http://www.ijirset.com)

Vol. 7, Special Issue 2, March 2018

computer database, we need a database management system such as MySQL Server. Since computers are very good at handling large amounts of data, database management systems play a central role in computing, as standalone utilities, or as parts of other applications.

### **MySQL databases are relational:**

A relational database stores data in separate tables rather than putting all the data in one big storeroom. The database structures are organized into physical files optimized for speed. The logical model, with objects such as databases, tables, views, rows, and columns, offers a flexible programming environment.

The SQL part of “MySQL” stands for “Structured Query Language”. SQL is the most common standardized language used to access databases. Depending on your programming environment, you might enter SQL directly (for example, to generate reports), embed SQL statements into code written in another language, or use a language-specific API that hides the SQL syntax.

SQL is defined by the ANSI/ISO SQL Standard. The SQL standard has been evolving since 1986 and several versions exist. “SQL-92” refers to the standard released in 1992, “SQL:1999” refers to the standard released in 1999, and “SQL:2003” refers to the current version of the standard. We use the phrase “the SQL standard” to mean the current version of the SQL Standard at any time.

### **MySQL software is Open Source:**

The MySQL software uses the GPL (GNU General Public License), <http://www.fsf.org/licenses/>, to define what you may and may not do with the software in different situations. If you feel uncomfortable with the GPL or need to embed MySQL code into a commercial application, you can buy a commercially licensed version from us. See the MySQL Licensing Overview for more information (<http://www.mysql.com/company/legal/licensing/>).

### **MySQL Server works in client/server or embedded systems:**

The MySQL Database Software is a client/server system that consists of a multi-threaded SQL server that supports different backends, several different client programs and libraries, administrative tools, and a wide range of application programming interfaces (APIs).

### **A large amount of contributed MySQL software is available:**

MySQL Server has a practical set of features developed in close cooperation with our users. It is very likely that your favorite application or language supports the MySQL Database Server.

### **JDBC**

In an effort to set an independent database standard API for Java; Sun Microsystems developed Java Database Connectivity, or JDBC. JDBC offers a generic SQL database access mechanism that provides a consistent interface to a variety of RDBMSs. This consistent interface is achieved through the use of “plug-in” database connectivity modules, or drivers. If a database vendor wishes to have JDBC support, he or she must provide the driver for each platform that the database and Java run on.

To gain a wider acceptance of JDBC, Sun based JDBC’s framework on ODBC. As you discovered earlier in this chapter, ODBC has widespread support on a variety of platforms. Basing JDBC on ODBC will allow vendors to bring JDBC drivers to market much faster than developing a completely new connectivity solution.

# International Journal of Innovative Research in Science, Engineering and Technology

(A High Impact Factor, Monthly, Peer Reviewed Journal)

Visit: [www.ijirset.com](http://www.ijirset.com)

Vol. 7, Special Issue 2, March 2018

JDBC was announced in March of 1996. It was released for a 90 day public review that ended June 8, 1996. Because of user input, the final JDBC v1.0 specification was released soon after.

The remainder of this section will cover enough information about JDBC for you to know what it is about and how to use it effectively. This is by no means a complete overview of JDBC. That would fill an entire book.

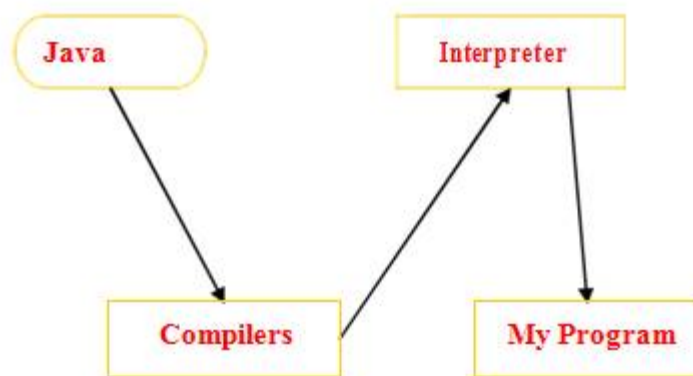

## V. CONCLUSION

The system achieves the location and data privacy preservation of secondary user in wireless cognitive networks. It also stores the data and geo-location of secondary user's information. Even if one of the coordinates is intentionally revealed by a SU, its location is still indistinguishable from remaining possible locations. This entity, referred to as query server (QS), has a dedicated high throughput link with DB. QS is used to guarantee computational location privacy while reducing the computational and communication overhead especially on SU's side.

## REFERENCES

- [1]. M. Grissa, A. A. Yavuz, and B. Hamdaoui, "Cuckoo filter-based location-privacy preservation in database-driven cognitive radio networks," in WSCNIS. IEEE, 2015, pp. 1-7.
- [2]. H. Zhu, C. Fang, Y. Liu, C. Chen, M. Li, and X. S. Shen, "You can jam but you cannot hide: Defending against jamming attacks for geolocation database driven spectrum sharing," IEEE Journal on Selected Areas in Communications, vol. 34, no. 10, pp. 2723-2737, 2016.
- [3]. W. Wang and Q. Zhang, Location Privacy Preservation in Cognitive Radio Networks. Springer, 2014.
- [4]. M. Grissa, B. Hamdaoui, and A. A. Yavuz, "Location privacy in cognitive radio networks: A survey," IEEE Communications Surveys & Tutorials, 2017.
- [5]. S. Li, H. Zhu, Z. Gao, X. Guan, K. Xing, and X. Shen, "Location privacy preservation in collaborative spectrum sensing," in INFOCOM, 2012 Proceedings IEEE. IEEE, 2012, pp. 729-737.
- [6]. M. Grissa, A. A. Yavuz, and B. Hamdaoui, "Lpos: Location privacy for optimal sensing in cognitive radio networks," in Global Communications Conference (GLOBECOM), 2015 IEEE. IEEE, 2015.
- [7]. M. Grissa, A. A. Yavuz, and B. Hamdaoui, "Preserving the location privacy of secondary users in cooperative spectrum sensing," IEEE Transactions on Information Forensics and Security, vol. 12, no. 2, pp.418-431, 2017.
- [8]. S. Liu, H. Zhu, R. Du, C. Chen, and X. Guan, "Location privacy preserving dynamic spectrum auction in cognitive radio network," in Distributed Computing Systems (ICDCS), 2013 IEEE 33rd International Conference on. IEEE, 2013, pp. 256-265.
- [9]. S. Selvakumari, M. Sumathi, "Multi-Channel Opportunistic Spectrum Analytics and Adaptive Channel Assignment in Cognitive Radio Networks" 2017 Asian Journal of Information Technology, vol.16, issue 2, pp.2348-363
- [10]. "Efficient location privacy for moving clients in database-driven dynamic spectrum access," in 2015 24<sup>th</sup> International Conference on Computer Communication and Networks (ICCCN). IEEE, 2015.
- [11]. Z. Gao, H. Zhu, Y. Liu, M. Li, and Z. Cao, "Location privacy in database-driven cognitive radio networks: Attacks and countermeasures," in INFOCOM, 2013 Proceedings IEEE. IEEE, 2013, pp. 2751-2759.
- [12]. B. Fan, D. G. Andersen, M. Kaminsky, and M. D. Mitzenmacher, "Cuckoo filter: Practically better than bloom," in Proc. of the 10th ACM Int'l Conference on emerging Networking Experiments and Technologies, 2014, pp. 75-88.





ISSN(Online): 2319-8753  
ISSN (Print): 2347-6710

## International Journal of Innovative Research in Science, Engineering and Technology

*(A High Impact Factor, Monthly, Peer Reviewed Journal)*

Visit: [www.ijirset.com](http://www.ijirset.com)

Vol. 7, Special Issue 2, March 2018

- [13].R. Pagh and F. F. Rodler, "Cuckoo hashing," Journal of Algorithms, vol. 51, no. 2, pp. 122–144, 2004.
- [14].W. Wang and Q. Zhang, "Privacy-preserving collaborative spectrum sensing with multipleservice providers," Wireless Communications, IEEE Transactions on, 2015.
- [15].M. Grissa, A. A. Yavuz, and B. Hamdaoui, "An efficient technique for protecting location privacy of cooperative spectrum sensing users," in Computer Communications Workshops (INFOCOM WKSHPS), 2016 IEEE Conference on. IEEE, 2016, to be published.
- [16].L. Zhang, C. Fang, Y. Li, H. Zhu, and M. Dong, "Optimal strategies for defending location inference attack in database-driven crns," in Communications (ICC), 2015 IEEE International Conference on.