

International Journal of Innovative Research in Science, Engineering and Technology

(A High Impact Factor, Monthly, Peer Reviewed Journal)

Visit: www.ijirset.com

Vol. 8, Issue 3, March 2019

A Small Scale Private Cloud Setup Using Ubuntu for Educational Institution

Dr.D.Venkata Subramanian, P.Siji², B.Manju³, M.P.Nisha⁴

Adjunct Professor, Department of CSE, Velammal Institute of Technology, Chennai, Tamil Nadu, India¹

U.G Students, Department of CSE, Velammal Institute of Technology, Chennai, Tamil Nadu, India^{2,3,4}

ABSTRACT: In the current era of automation, many fields have been benefited by using technologies. So, it will be even more if we bring into the stream of education. This would reduce the work load and make the work simpler. The paper aims to build a private cloud for the instruction. The Cloud can be accessed only by the faculty members and the students if the institution. Using this technology, replication of data can be controlled to a maximum extent. Also redundancy can be controlled and sharing of information is more convenient and easier. Yes there are Cloud which are used by various industries for their purposes. Here, we try to deploy a cloud where faculty members can share assistance required for examination and learning purposes. The cloud can handle data sent in the form of document, images, audio files and videos. Different functionality implemented in the Cloud can handle all types of data.

KEYWORDS: Private cloud, Openstack, Private Cloud, Cloud Computing, learning institution;

I. INTRODUCTION

The evolving technology is working as a helping hand to Many people in many streams. The paper aims to bring in the cutting edge of Cloud Computing in terms to make the work easy in the field of education. Cloud computing is a style of computing in which dynamically scalable and often virtualized resources are provided as a service over the Internet. Cloud computing is a model for enabling ubiquitous, convenient, on-demand network access to a shared pool of configurable computing resources (e.g., networks, servers, storage, applications, and services) that can be rapidly provisioned and released with minimal management effort or service provider interaction. Here, we intended to develop a private Cloud for our institution to the welfare of staff and students. Positively, this cloud is accessible only by the staff and students of institution. In the developed cloud, the faculty member can upload the studying assistance. The assistance may be a document, audio file or videos. All these above are possible since the cloud consists of various functional capabilities to handle all such type of updates. At the other end, students can access the cloud and handle the assistance. Separate login identity is provided to facilities and students so that they can access through the I'd. Hence, this will be a convenient methodology in helping institution to share data.

II. LITERATURE REVIEW

Guoxia Zou [3] has presented a framework that provides a designs the overall architecture of user access to private cloud. According to the design of the whole architecture, the private cloud platform is deployed. According to the characteristics of openstack private cloud platform, users management platform is designed. User management platform through the user access to private cloud platform. According to the components and functions of openstack, this paper designs the overall architecture of user access to private cloud. According to the design of the whole architecture, the private cloud platform is deployed. According to the characteristics of openstack private cloud platform, users management platform is designed. User management platform through the user access to private cloud platform.

International Journal of Innovative Research in Science, Engineering and Technology

(A High Impact Factor, Monthly, Peer Reviewed Journal)

Visit: www.ijirset.com

Vol. 8, Issue 3, March 2019

Mohsen Karimzadeh Kiskani [4] have studied the problems of security and private information retrieval in distributed storage systems which are using a full rank encoding scheme based on Random Linear Fountain (RLF) codes. Providing a random combinations of all contents that are stored across the network by using Random Linear Fountain (RLF) codes. SAPIR achieves asymptotic perfect secrecy. To retrieve a content, a group of servers collaborate with each other to form a Repair Group (RG). Further, an information theoretic Private Information Retrieval (PIR) scheme based on random queries is proposed that ensures a user privately downloads its desired content without the servers knowing the requested content index. The proposed scheme is adaptive and can provide privacy against a significant number of colluding servers.

III. PROPOSED SYSTEM

A cloud storage is created and it is given access privately. A separate login for all the staff is provided. Similarly, login is given commonly for all students. The staff can login to their profile share the file. The students can retrieve the information when ever needed. Private Cloud Platform For Colleges And Universities Education Resources includes two parts of hardware and software. The hardware part mainly use OPENSTACK to build iaas, All hardware in school will be connected together as a whole through the network and openstack. Software part is based on the IAAs platform, it realized remote login authentication, after the user authentication succeeded, user can access to the corresponding resources and has corresponding operating rights.

IV. PROPOSED SYSTEM ARCHITECTURE DIAGRAM

The following is the architecture diagram for the proposed system. The User Access layer is responsible for accepting user request. Content Repository is the place for storing digital content which allows application to search, access and manage contents.

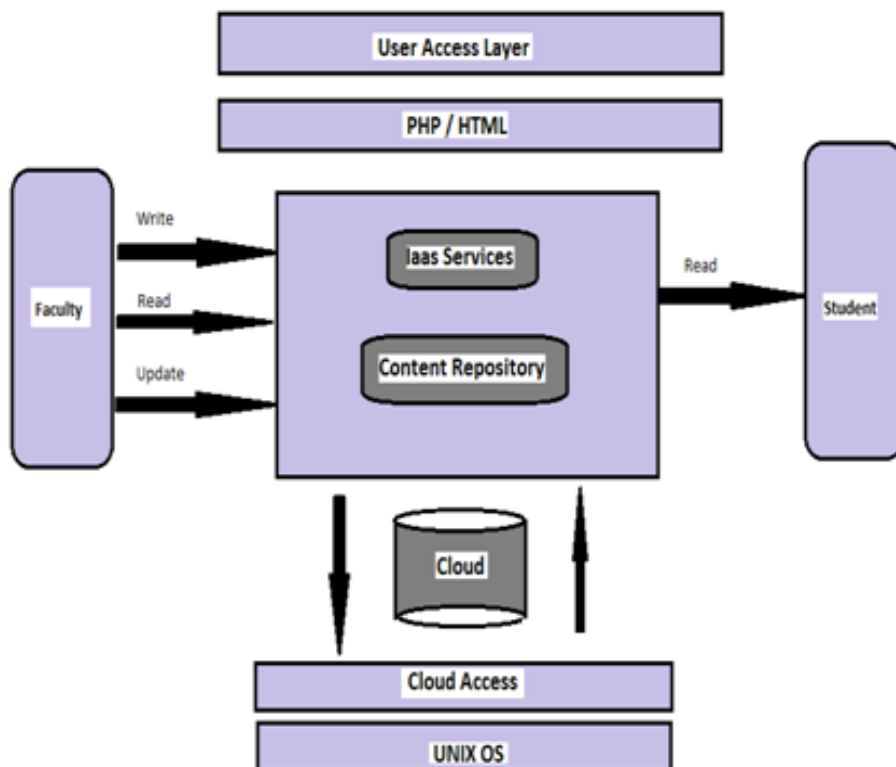

International Journal of Innovative Research in Science, Engineering and Technology

(A High Impact Factor, Monthly, Peer Reviewed Journal)

Visit: www.ijirset.com

Vol. 8, Issue 3, March 2019

V.INTEGRATING VARIOUS CLOUD SERVICES

INTRODUCTION OF OPENSTACK:

Cloud computing is a style of computing in which dynamically scalable and often virtualized resources are provided as a service over the Internet. Cloud computing is a model for enabling ubiquitous, convenient, on-demand network access to a shared pool of configurable computing resources (e.g., networks, servers, storage, applications, and services) that can be rapidly provisioned and released with minimal management effort or service provider interaction.

CLOUD COMPUTING SERVICES:

Cloud computing services provided by the resource type is divided into three categories: infrastructure as a service (IaaS), platform as a service (PaaS) and software as a service (SaaS)[1-2].

IaaS: hardware equipment basic resources in service for users. In IaaS environment, the user is equivalent to in the use of bare-metal and disk, can let it run Windows, also can let it run Linux. IaaS biggest advantage is that it allows the user to dynamic application or release the node, charged according to usage. The IaaS is Shared by the public, thus has higher efficiency of resource use.

THE COMPONENTS OF OPENSTACK:

Nova:

It create an abstraction layer, let the CPU, memory, network adapter and server virtualization resources goods such as hard disk drives, and have the ability to improve the efficiency and automation.

Keystone:

It Management user directory, and users can access it service catalog. it exposed a central authentication mechanisms. Keystone itself does not provide Authentication, it can integrate various other Directory service, such as Pluggable Authentication Module, Lightweight Directory Access Protocol (LDAP) or request.

Neutron/Quantum:

Known as Quantum before Neutron, it provides the ability to manage local area network (LAN), have applied to virtual local area network (VLAN), dynamic host configuration Protocol and Internet Protocol version 6 features. User can define network, subnet, and routers to configure its internal topology, then assigned to the network IP address and VLAN. Floating IP address allows the user to the VM allocation fixed external IP address.

Cinder:

Cooperate with Cinder storage is the most common used Linux server storage. The system provides the additional piece of equipment used to create a piece of equipment, to the server and separation from the server block device interface. In addition, Cinder volumes can be used to backup system.

Swift:

it is the ideal redundant Storage systems. It ensures that all equipment in the pool of data replication and distribution, let users can take advantage of the commercial hard disk and the server, rather than the more expensive the equipment. If a component fails, the contents of a system from other activities, so it can be added to the new cluster member. The architecture also supports the horizontal extension, because it is easy to use other server according to need to extend the storage cluster. Swift is a distributed storage system, mainly for the static data, such as the VM image, backup and archive. The software to write documents and other objects into the possible distribution in one or more multiple servers within the data center of a set of disk drives, to ensure the data replication and integrity within the entire cluster.

International Journal of Innovative Research in Science, Engineering and Technology

(A High Impact Factor, Monthly, Peer Reviewed Journal)

Visit: www.ijirset.com

Vol. 8, Issue 3, March 2019

Glance:

It supports the VM images ,Glance mirror can serve as a template, quickly and consistently to deploy a new server, users can use it to list and get assigned to a set of extensible back-end Storage of the virtual disk image.

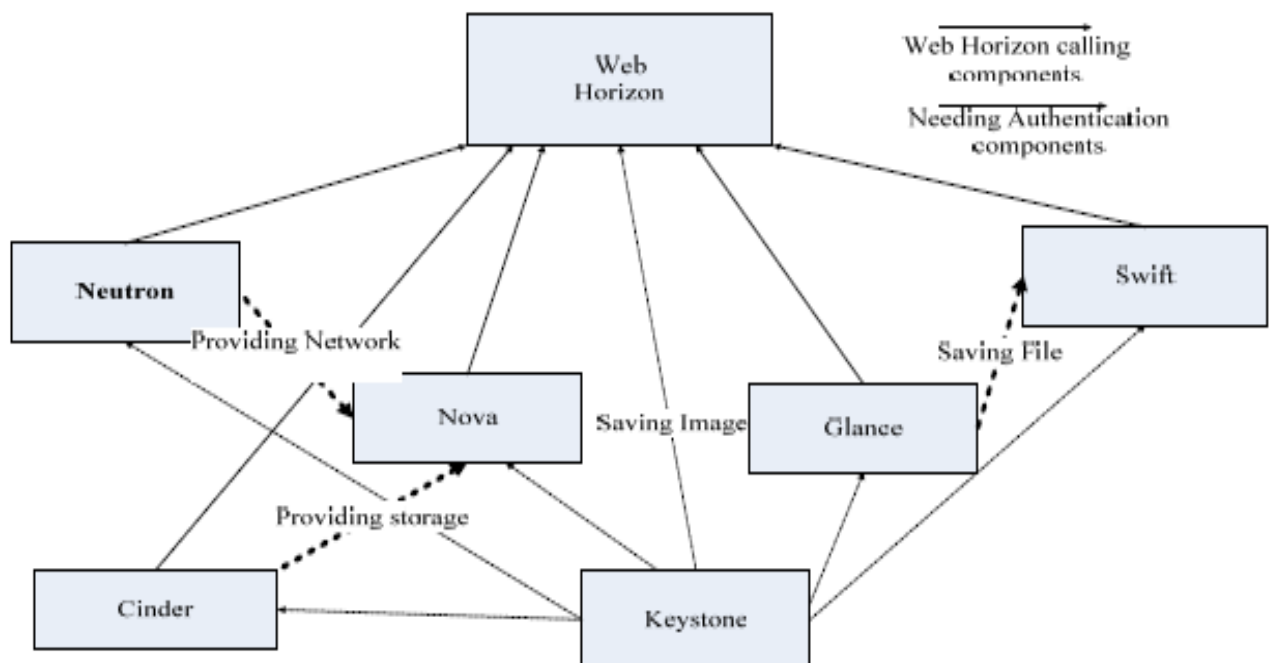

The Main Components Of OPENSTACK

THE DESIGN OF PRIVATE CLOUD PLATFORM:

Private Cloud Platform For Colleges includes two parts of hardware and software. The hardware part mainly use OPENSTACK to build iaas, All hardware in school will be connected together as a whole through the network and openstack. Software part is based on the IAAs platform, it realized remote login authentication, after the user authentication succeeded, user can access to the corresponding resources and has corresponding operating rights.

CODING PROCEDURE:

- Install Ubuntu 16.04
- Add Stack User

Devstack should be run as a non-root user with sudo enabled.

```
sudo useradd -s /bin/bash -d /opt/stack -m stack
```

International Journal of Innovative Research in Science, Engineering and Technology

(A High Impact Factor, Monthly, Peer Reviewed Journal)

Visit: www.ijirset.com

Vol. 8, Issue 3, March 2019

```
echo "stack ALL=(ALL) NOPASSWD: ALL" | sudo tee /etc/sudoers.d/stack
```

```
sudo su - stack
```

- Download DevStack
- Download git packages

THE DESIGN OF USER MANAGEMENT SYSTEM:

User management platform can be accessed by different clients, When the user access platform, users need to access to different platforms according to the needs of user. There are three major categories according to the system:

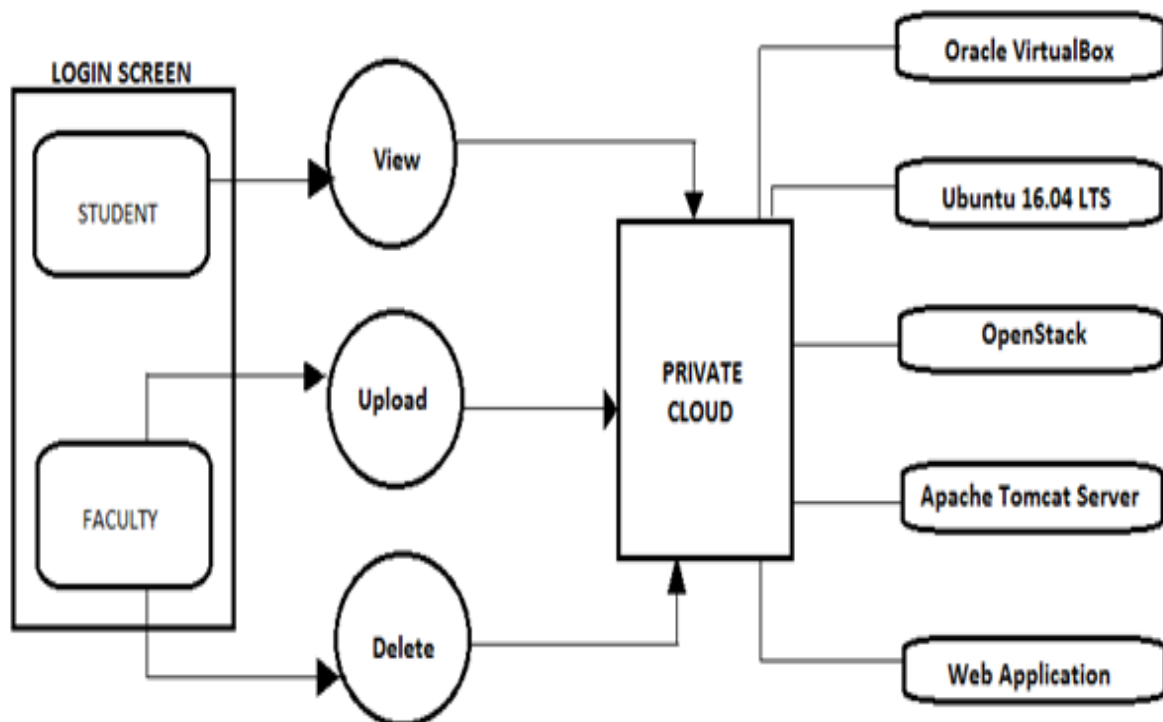

International Journal of Innovative Research in Science, Engineering and Technology

(A High Impact Factor, Monthly, Peer Reviewed Journal)

Visit: www.ijirset.com

Vol. 8, Issue 3, March 2019

VI.OUTPUT SCREENS

HOME PAGE

After signing into the application, the below given home page is visible.



Fig.6.1 Home Page

STAFF LOGIN

Staff can perform the needed actions after successfully signing into their account.

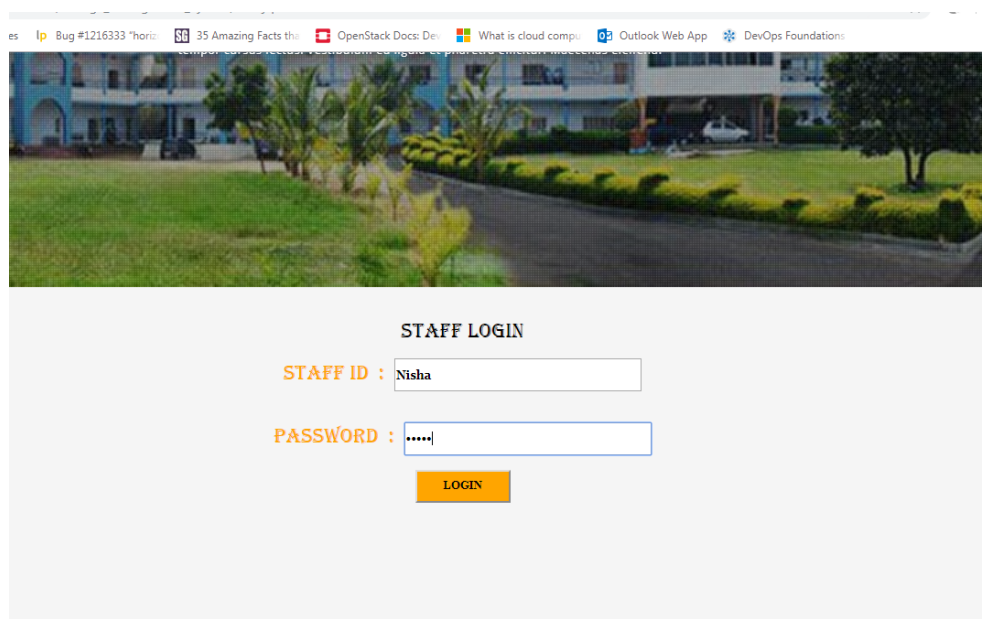

Fig.6.2 Staff login page

International Journal of Innovative Research in Science, Engineering and Technology

(A High Impact Factor, Monthly, Peer Reviewed Journal)

Visit: www.ijirset.com

Vol. 8, Issue 3, March 2019

UPLOAD FILES

Staff can upload files such as notes, question banks, audios, videos, assignment questions from their respective account by signing in.

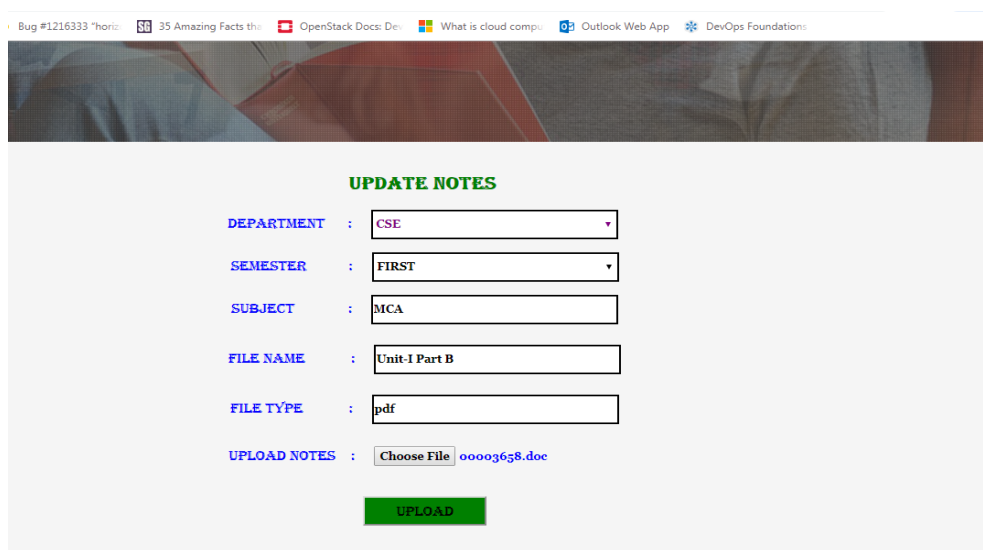

UPDATE NOTES

DEPARTMENT : CSE

SEMESTER : FIRST

SUBJECT : MCA

FILE NAME : Unit-I Part B

FILE TYPE : pdf

UPLOAD NOTES : 00003658.doc

Fig.6.3 Upload files page

STUDENTS REGISTRATION

Students of the Institution can access the cloud only after they are provided their specific account. And for that, they must register in the student registration form.

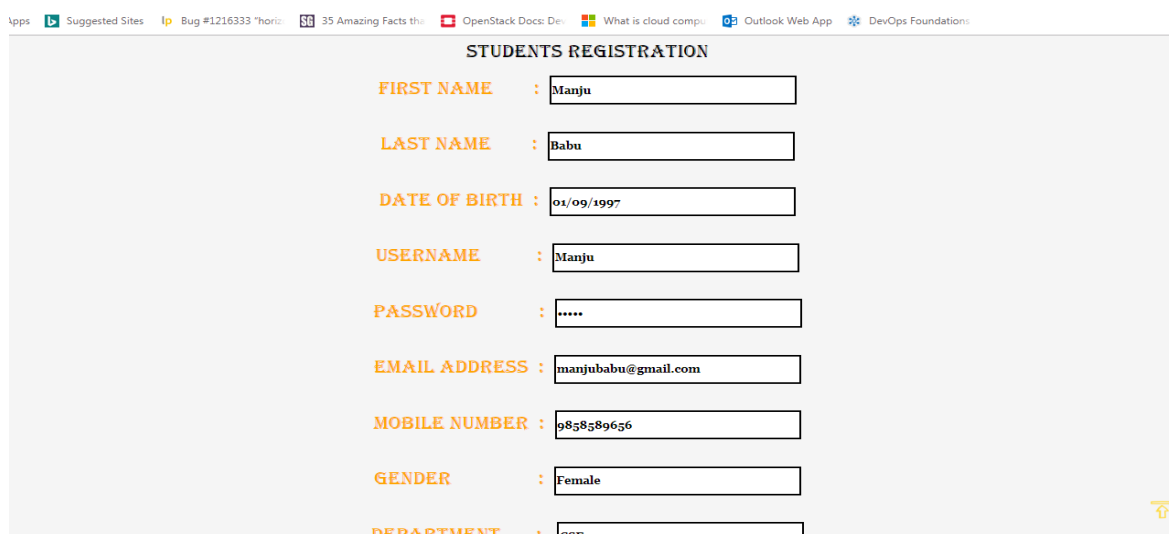

STUDENTS REGISTRATION

FIRST NAME : Manju

LAST NAME : Babu

DATE OF BIRTH : 01/09/1997

USERNAME : Manju

PASSWORD : ****

EMAIL ADDRESS : manjubabu@gmail.com

MOBILE NUMBER : 9858589656

GENDER : Female

DEPARTMENT : CSE

Fig.6.4.1 Student Registration form

International Journal of Innovative Research in Science, Engineering and Technology

(A High Impact Factor, Monthly, Peer Reviewed Journal)

Visit: www.ijirset.com

Vol. 8, Issue 3, March 2019

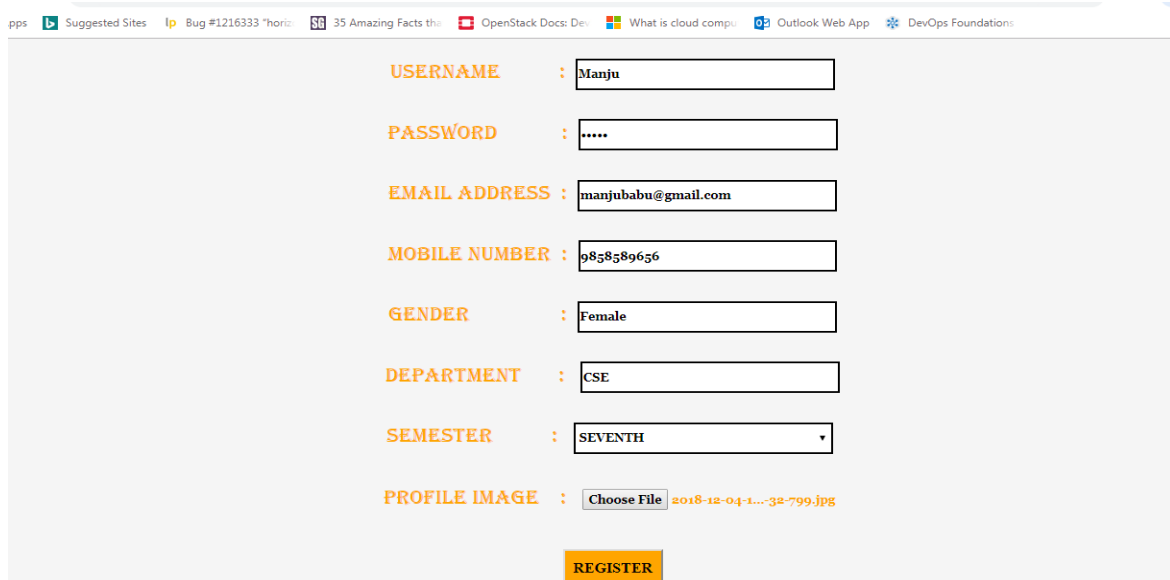

ppps Suggested Sites Bug #1216333 *horiz: 35 Amazing Facts the OpenStack Docs: Dev What is cloud compu Outlook Web App DevOps Foundations

USERNAME :
PASSWORD :
EMAIL ADDRESS :
MOBILE NUMBER :
GENDER :
DEPARTMENT :
SEMESTER :
PROFILE IMAGE : 2018-12-04-1...-32-799.jpg

Fig.6.4.2 Student Registration form

DOWNLOAD FILES

Students can download the files which are upload by the staff .

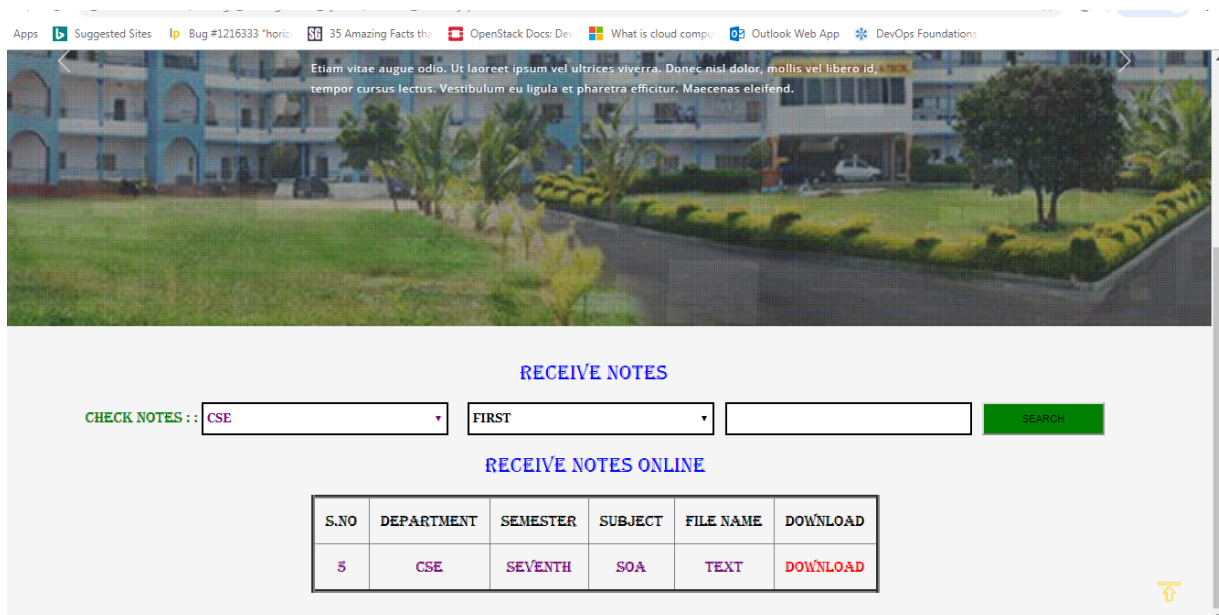

Apps Suggested Sites Bug #1216333 *horiz: 35 Amazing Facts the OpenStack Docs: Dev What is cloud compu Outlook Web App DevOps Foundations

Etiam vitae augue odio. Ut laoreet ipsum vel ultrices viverra. Donec nisl dolor, mollis vel libero id, tempor cursus lectus. Vestibulum eu ligula et pharetra efficitur. Maecenas eleifend.

RECEIVE NOTES

CHECK NOTES ::

RECEIVE NOTES ONLINE

S.NO	DEPARTMENT	SEMESTER	SUBJECT	FILE NAME	DOWNLOAD
5	CSE	SEVENTH	SOA	TEXT	DOWNLOAD

Fig.6.5 Receive notes page

International Journal of Innovative Research in Science, Engineering and Technology

(A High Impact Factor, Monthly, Peer Reviewed Journal)

Visit: www.ijirset.com

Vol. 8, Issue 3, March 2019

ASSIGNMENT SUBMISSION

Not only notes, but also the assignments can be submitted online by the students so that the respected staff will be able to take a look at them their specified account.

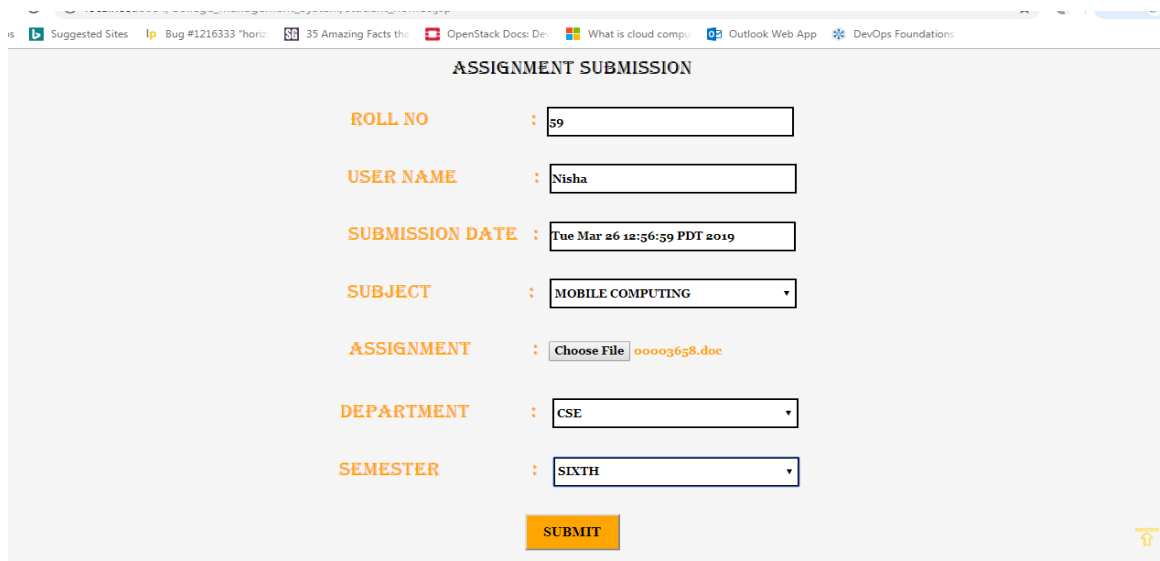

The screenshot shows a web browser window with the title "ASSIGNMENT SUBMISSION". The page contains several form fields for submission details:

- ROLL NO : 59
- USER NAME : Nisha
- SUBMISSION DATE : Tue Mar 26 12:56:59 PDT 2019
- SUBJECT : MOBILE COMPUTING
- ASSIGNMENT : Choose File 00003658.doc
- DEPARTMENT : CSE
- SEMESTER : SIXTH

A yellow "SUBMIT" button is located at the bottom of the form. The browser's address bar and tabs are visible at the top of the window.

Fig.6.6 Assignment Submission page

VII.CONCLUSION

In this paper, the concept of Cloud Computing is put forth into stream of education after taking a detailed study on the technology. The proposed system uses Open stack which gives an added advantage of introducing any new update in the existing. Since many functionalities are deployed, any form of data can be handled here which intern helps the faculty sharing of required form of data. The introduced system also reduces redundancy of data. The proposed system provided a simple and easy manner of finding and retrieving information needed.

VIII.FUTURE WORK

Speech recognition is the inter-disciplinary sub-field of computational linguistics that develops methodologies and technologies that enables the recognition and translation of spoken language into text by computers. It incorporates knowledge and research in the linguistics, computer science and electrical engineering fields. Some speech recognition systems require "training" (also called "enrollment") where an individual speaker reads text or isolated vocabulary into the system. The system analyzes the person's specific voice and uses it to fine-tune the recognition of that person's speech, resulting in increased accuracy. Systems that do not use training are called "speaker independent" systems. Systems that use training are called "speaker dependent".

This project can be enhanced to a network based interactive speech system **responds in real-time to speech-based queries** addressed to a set of topic entries. **A best matching response** is searched from the private cloud based on speech recognition processing and natural language processing performed on recognized speech utterances to identify a selected set of phrases related to the set of topic entries.

International Journal of Innovative Research in Science, Engineering and Technology

(A High Impact Factor, Monthly, Peer Reviewed Journal)

Visit: www.ijirset.com

Vol. 8, Issue 3, March 2019

REFERENCES

- [1] Guoxia Zou, The Design Of Private Cloud Platform For Colleges And Universities Education Resources Based On Openstack, 4th National Conference on Electrical, Electronics and Computer Engineering, 2015.
- [2] Mohsen Karimzadeh Kiskani and Hamid R. Sadjadpour, Secure And Private Information Retrieval (SAPIR) in Cloud Storage Systems, [IEEE Transactions on Vehicular Technology](#) (Volume: 67 , Issue: 12 , Dec. 2018)
- [3] Hsin Tse Lu, Chia Hung Kao, Towards A Hosted Private Cloud Storage Solution for Application Service Provider, [Proceedings of International Conference on Cloud Computing and Internet of Things](#), 2014.
- [4] Ma Wenjie, Research and Application of College Experimental Cloud Platform on OpenStack, Journal of Suihua University, Dec . 2014,Pages:146-150.
- [5] Guo Xin, Zhang Danjue, A Study on Digital Campus Architecture Based on OpenStack, Microcomputer Applications Vol. 30, No.10, 2014,Pages: 49 – 52.
- [6] Li Lei,Li Xiaoning,Jin Lianwen, Construction an educational and scientific cloud computing platform based on Openstack and its application, Experimental Technology and Management, Vol.31 No.6, Jun.2014,Pages:127-133,174.
- [7] Zhao Shaoka , LI Liyao , Ling Xiao, Xu Cong, Architecture and scheduling scheme design of TsinghuaCloud based on OpenStack,Journal of Computer Applications,33(12),2013,Pages: 3335-3338,3349. 995
- [8] Huang Zhicheng,Research on Application of Open Source Cloud Computing In Computer Rooms of Universities, JISUANJI YU XIANDAIHUA ,2013,Pages: 204-206,211.
- [9] Yang Shaoguang,Zhang Yunyong,Chen Qingjin,Pan Songbai, Study of Cloud Computing IaaS Management Platform Based on Openstack,China Internet,(3)2013.
- [10] A cloud storage service for private cloud solution. [Online]. Available:<http://home.oxygencloud.com>.
- [11] C. H. Kao and S. T. Liu, "A prototype system for object management in private cloud," in Cloud and Service Computing (CSC), 2011 International Conference on, Dec 2011, pp. 348–353.
- [12] G. Wang and J. Unger, "A strategy to move taiwan's it industry from commodity hardware manufacturing to competitive cloud solutions," Access, IEEE, vol. 1, pp. 159–166, 2013
- [13] S. H. Kim and D. Kim, "Multi-tenancy support with organization management in the cloud of things," in Services Computing (SCC), 2013 IEEE International Conference on, June 2013, pp. 232–239. [14] X. Zhang, P. Sun, Y. Huang, and W. Sun, "A model-driven framework for enabling self-service configuration of business services," in Web Services, 2008. ICWS '08. IEEE International Conference on, Sept 2008, pp. 497–504.
- [15] K. Ren, C. Wang, and Q. Wang, "Security challenges for the public cloud," Internet Computing, IEEE, vol. 16, no. 1, pp. 69–73, Jan 2012.