

International Journal of Innovative Research in Science, Engineering and Technology

(A High Impact Factor, Monthly, Peer Reviewed Journal)

Visit: www.ijirset.com

Vol. 8, Issue 3, March 2019

IoT-based Environmental and Ionizing Radiation Monitoring System

TAMBASAFIDY Francisco Pascal Elias^{1*}, RATONGASOANDRAZANA Jean Baptiste²,

ANDRIANIAINA Hery³, RABESIRANANA Naivo⁴, RAJAOBELISON Joël⁵

Ph.D Student, Department of Maintenance and Instrumentation, INSTN-Madagascar, Antananarivo, Madagascar^{1*}

Ph.D, Department of Maintenance and Instrumentation, INSTN-Madagascar, Antananarivo, Madagascar²

Ph.D, Department of Maintenance and Instrumentation, INSTN-Madagascar, Antananarivo, Madagascar³

Professor, Technical and Development Director, INSTN-Madagascar, B.P.4279, Antananarivo, Madagascar⁴

Professor, Director General, INSTN-Madagascar, B.P.4279, Antananarivo, Madagascar⁵

*Corresponding author

ABSTRACT: Presence of air pollutant and uncontrolled release of radioactivity to the environment due to human activities, leads us to consider how important are the environmental parameters monitoring to ensure public safety. To remotely monitor, in real time, the air quality and the ionizing radiation level of the surrounding environment, an IoT-based (Internet of Things) system which is composed of a set of interconnected equipment which is able to monitor and collect data from the environment, was designed and implemented at the Madagascar Institute for Nuclear Sciences and Technologies (INSTN-Madagascar). The system consists of *i*) several sensing nodes based on esp8266 microcontroller equipped with sensors measuring environmental parameters i.e. air quality and ionizing radiation, *ii*) a central server for sensor data processing, event notification, real-time analytics and data storage and finally *iii*) a nearly real-time web and android applications that operate from remote computers and mobile phones for remote access. The system was designed to be easily scaled-up to measure as well other parameters of interest. In this paper, the overall description of the system's architecture and software components is shown and workability proved.

KEYWORDS: Environment, ionizing radiation, Internet of Things, Arduino, Android.

I. INTRODUCTION

The oxygen contained in the air which we inhale is an important and necessary element for life. However, daily anthropogenic activities, such as wood burning for cooking, vehicles motors, industries, wild fires and energy production, generate significant amount of air pollutants that affect our health and the environment. Urban air pollution is a major problem in many developing as well as developed countries. The results of atmospheric pollutants measurements carried out by the "Institut National des Sciences et Techniques Nucléaires" (INSTN-Madagascar), have shown that Antananarivo, the capital of Madagascar, is one of the most polluted cities in the world. The increasing and alarming evolution of diseases such as stroke, heart disease, lung cancer, chronic obstructive pulmonary disease and respiratory infections, including pneumonia, tend to confirm this statement.

In addition, Madagascar has many natural radioactive substances in its subsoil. Moreover, the use of man-made radioactive sources is more and more increasing in hospitals, industries and mining companies. That is hence increasing the exposure risk affecting the population from external ionizing, internal contamination and the presence of radioactive waste. But few devices have been developed locally to remotely detect and measure radioactivity to support local expertise in terms of radiation survey.

International Journal of Innovative Research in Science, Engineering and Technology

(A High Impact Factor, Monthly, Peer Reviewed Journal)

Visit: www.ijirset.com

Vol. 8, Issue 3, March 2019

The recent development of low-cost and open-source microcontroller such as Arduino [12], wireless communication, Internet-of-Things (IoT) [1, 2] technologies and open-source software play an important role addressing many of these issues. It offers the potential to automate and simplify the information collection and analysis. These technologies provide a powerful remote monitoring tool for supervising air quality and ionizing radiation in real time and offer opportunities to enhance decision-making over the short-, medium- and long-term.

Previous work was developed at the INSTN-Madagascar by the researchers of Department of Maintenance and Instrumentation for remote monitoring of ionizing radiation level of a contaminated area using Radio Frequency controlled robot-vehicle based on ATmega128L microcontroller. This robot-vehicle is equipped with a video camera module and is able to remotely detect, identify and map the radioactive contaminated area.

The present research work focuses on the development of an IoT-based radiological and environmental monitoring system that monitor remotely temperature, pressure, humidity, air quality and ionizing radiation of the surrounding environment.

The present paper is organized as follows: the first section describes some related technologies involved in this work. Section II introduces the components of the proposed system. Section III is devoted to describe the main features of the implemented web and android application. In Section IV, we conduct preliminary experiments to prove and evaluate the workability of the prototype and discuss the results. Finally, Section V presents the conclusion and prospective.

II. PREVIOUS RELATED WORK

The Internet of Things (IoT) is, essentially, a massive big data gathering tool. With IoT, a large number of small and low-power sensors are collecting data over the time for a wide range of fields and applications resulting big data streams. Analysis of such data streams is a crucial process that needs quick response for an appropriate decisions and predictive actions according to the circumstance.

Several research efforts have been conducted to integrate IoT in our daily activities to facilitate our lives. Environmental monitoring is one of the broad applications for the Internet of Things. The work presented by Nyoman Putra Sastra [17] was focused on environmental monitoring as an IoT application in building “smart campus of Universitas Udayana” using the low cost DHT11 sensor as temperature and humidity sensors. Kotipalli Manasa [18] proposed a technique to monitor and analyse air pollution such as CO and CO₂ in the atmosphere using “smart citizen kit” based on Arduino platform.

For the present work, the combined use of both air quality and ionizing radiation monitoring system based on IoT is designed and implemented.

III. THE PROPOSED SYSTEM

The main contribution of this paper involves both hardware and software design. The proposed system architecture includes three main modules detailed as follows:

- Wireless Sensor Network
- Web server
- Web and android applications

The block diagram of the system is shown in Figure 1. Wireless sensor network communicates with web server using Wi-Fi network. Then the web server sends, over the Internet, sensor data measurements to remote computers running Web and android applications.

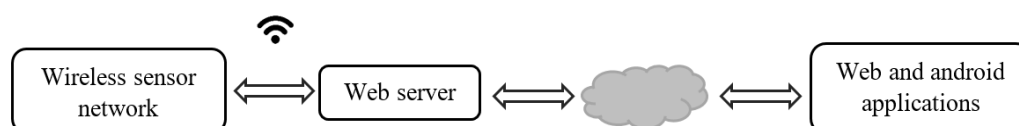

Fig. 1. High level view of the system block diagram

International Journal of Innovative Research in Science, Engineering and Technology

(A High Impact Factor, Monthly, Peer Reviewed Journal)

Visit: www.ijirset.com

Vol. 8, Issue 3, March 2019

A. Wireless Sensor Network

The monitoring system is based on a collaboration node through a wireless sensor network consisting of spatially distributed autonomous sensor nodes, each includes an esp8266-Arduino [5] compatible microcontroller and one or 2 environmental sensors. The ESP8266 was programmed with the Arduino IDE [12] to collect, pre-process, and transmit sensor data from its environment to the remote web server through WiFi network using MQTT (Message Queuing Telemetry Transport) protocol [16]. MQTT is a publish/subscribe, simple and lightweight messaging protocol, designed for constrained devices and low-bandwidth, high-latency or unreliable networks. It is ideal for IoT devices like ESP8266.

The sensors and detector used in this system are given in the next sections.

1. Physical sensors

a. DHT22 sensor

DHT22 is a digital temperature and humidity sensor based on AM2302 with a single wire digital interface[19]. It uses a thermistor and a capacitive humidity sensor to measure the surrounding air, and spits out a digital signal on the data pin. Its temperature measuring range is from -40 to +125 degrees Celsius with ± 0.5 degrees accuracy. Its humidity measuring range is from 0 to 100% with 2 to 5% accuracy. The schematic diagram of DHT22 sensor is shown on figure 2.a. It uses the simplified single-bus technology for communication, in which only one data line is applied for data exchange and data control in the system. In applications, an external pull-up resistor, about 5.1k Ω , is required. Figure 2.b shows the DHT22 module.

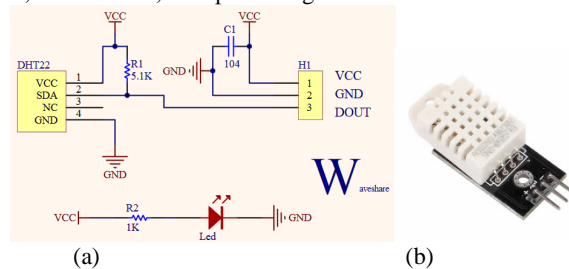

Fig. 2. (a) Schematic diagram of DHT22, (b) DHT22 module

b. BMP-280 sensor

BMP-280, an upgraded version of the old BMP180, provides precise measurement of barometric pressure and temperature of the environment [22]. The air pressure can be measured in a range from 300 hPa to 1100hPa with ± 1.0 hPa absolute accuracy. As for the temperature, the sensor works perfectly for temperatures range between - 40 and 85 with an accuracy of ± 1 . Figure 3.a shows a simplified block diagram of the BMP280 sensor which has pressure and temperature sensors both connected to an internal analogue to digital converter (ADC) via the front-end circuits. Measured signals are processed and transferred to ESP8266 microcontroller by a logic circuit using I²C serial communication protocol. Figure 3.b presents the BMP-208 module.

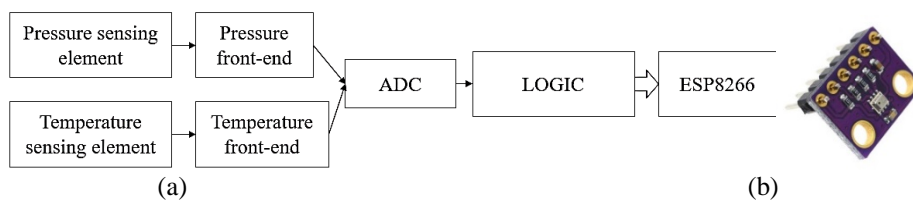

Fig. 3. (a) Bloc diagram of BMP280, (b) BMP280 module

International Journal of Innovative Research in Science, Engineering and Technology

(A High Impact Factor, Monthly, Peer Reviewed Journal)

Visit: www.ijirset.com

Vol. 8, Issue 3, March 2019

2. Air quality sensors

Air quality sensors are devices that detect and monitor the presence of air pollution in its surrounding area [20]. MQ series were used as air quality sensors for this work. Figure 4.a. shows the internal circuit of a typical MQ gas sensor. They are all resistive sensors which are sensitive to a range of gas and use a small heater inside with an electro-chemical sensor.

The variable resistance R_L is necessary to form a voltage divider with the internal resistance of the sensor. When gas concentration increases, the conductivity of the sensor resistance increases too, and so the output voltage V_{OUT} which is sent to ESP8266's analogue input for further processing. Figure 4.b shows the MQ gas sensor modules used in this system.



Fig. 4. (a) Internal circuit of an MQ gas sensor, (b) MQ gas sensor modules

Following are the list of MQ series sensors (figure 3.b) used in this prototype. Each of them is assigned for the detection of a different set of substances in the air.

- ✓ MQ-135: used for detection of NH_3 , NO_x , alcohol, Benzene, smoke, CO_2 .
- ✓ MQ-9: used for detection of LPG, CO , and CH_4
- ✓ MQ-6: used for detection of LPG, butane

It can be noted that the MQ series sensors are not one substance specific. That means that one sensor cannot discriminate between a groups of substances it can detect. To overcome this constraint, the use of a set of different MQ sensors is then proposed in this work to allow discrimination by elimination and subtraction. Hence, a detection by MQ-6 and non-detection by MQ-9 means that detected substance is a butane gas.

3. Ionizing radiation detector

An LND7313 Pancake Mica Window- α - β - γ Geiger Muller detector [21] is used in this prototype to detect and measure the ionizing radiation of the surrounding environment. It can detect the Alpha, Beta and Gamma radiations with a sensitivity of 60 pulses per second per $1mR.h^{-1}$ for the ^{60}Co source. Bloc diagram of the ionizing radiation detector module is shown on figure 5.a.

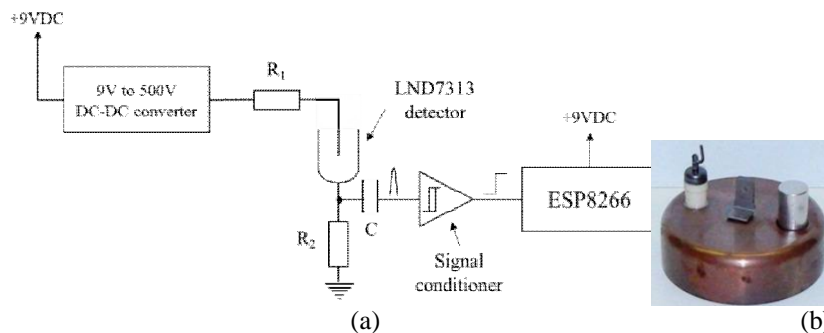

Fig. 5. (a) Bloc diagram of ionizing radiation detector, (b) LND7313 Pancake Mica detector

International Journal of Innovative Research in Science, Engineering and Technology

(A High Impact Factor, Monthly, Peer Reviewed Journal)

Visit: www.ijirset.com

Vol. 8, Issue 3, March 2019

A step up DC-DC converter module which convert the +9VDC supply voltage to +500VDC is used for the polarization of the detector. When ionizing radiation interact with Geiger Muller detector gas, a nuclear pulse is generated. This pulse is then converted to digital pulse by a signal conditioner circuit and sent to ESP8266 microcontroller for nuclear event counting. Figure 5.b reports the LND7313 Pancake Mica detector.

Figure 6 shows block diagram of each sensor node (ESP8266 + sensors), programmed to transmit wirelessly its data to remote web server through Wi-Fi network:



Fig. 6. Block diagrams of the sensor nodes

B. Web server

The web server centralizes all system signals. It receives data from sensor nodes, processes and stores them into a database and make the processed data available to the internet for remote users.

For the development and the logic of the web server, we adopted Node-RED environment [7] which is available in form of a native Windows application. Node-RED, the critical components of the web server, is a flow-based programming tool, originally developed by IBM's Emerging Technology Services team and now a part of the JS Foundation. Node-Red is running on Node.js server which is a JavaScript runtime built on Chrome's V8 JavaScript engine [16].

Mosquitto, an open source MQTT server [13], was used by the web server to receive data from sensor nodes and communicate it to the web client and the android application. Node-Red server receives (sends) sensors' data from (to) Mosquitto server which in turn forwards related information to all connected remote computers using MQTT protocol.

InfluxDB, an open-source time-series database that is optimized for fast, high-availability storage[14], was installed alongside Node-Red server to store sensor data and make it available to the web client and android application. InfluxDB is optimized for time-series data structures like those generated by IoT devices (sensor nodes).

Mosquitto server, Node-Red server, and InfluxDB time-series database server were all installed on the same platform. Node-Red server (web server) implements the algorithm to manage Mosquitto server (MQTT server) as well as InfluxDB time-series database server as illustrated by figure 7.

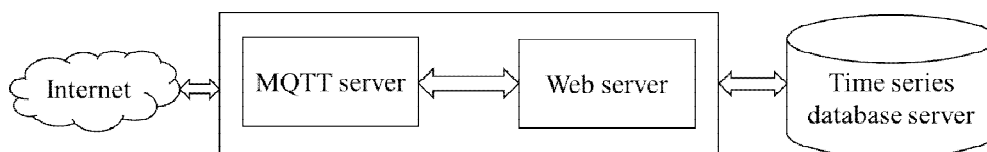

Fig. 7. Server application components

C. Web and Android applications

A Web-based and android application, coupled with warning notification, gives users access to detailed real-time information about the area of interest where sensor nodes are placed. Web application was designed based on Node-Red and mobile application was deployed using an Android studio [15]. These applications dynamically display all instantaneous environment parameters collected from sensor nodes with changing colours to indicate the safety status. For users to view detailed collected data from a specific interval of time, graph visualization interface was built for each sensor data type.

International Journal of Innovative Research in Science, Engineering and Technology

(A High Impact Factor, Monthly, Peer Reviewed Journal)

Visit: www.ijirset.com

Vol. 8, Issue 3, March 2019

These applications also provide the following functionalities to the user:

- User can choose the type of data to plot by selecting it from a drop down list located at the left corner of the web application or by just clicking on it in the android application.
- To smooth the curve, dots which form the curve can be grouped by a specified time interval (in the “group by ...” drop down list for the web application and in the configuration interface (figure 10.c) for the android application)
- User can navigate by time to view the graph of the collected data between in a specified time interval.

Figure 8 presents the four implemented sensor nodes. Three of them are equipped with one of the air quality sensors as described in previous section.

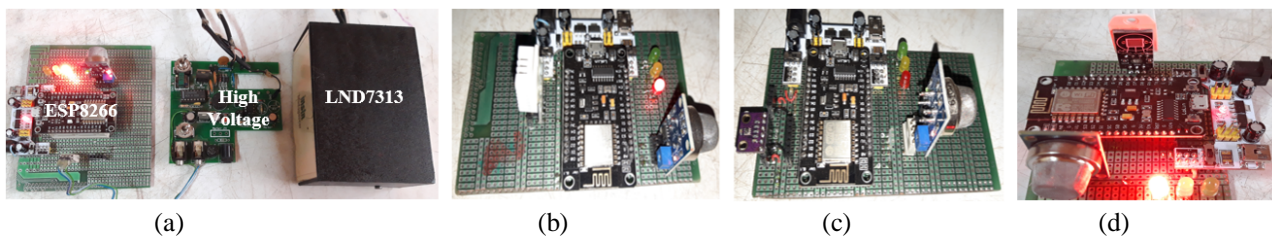

Fig. 7. (a) Radiation sensor; (b), (c) and (d) air quality sensors

IV. QUALITATIVE EVALUATION

The goal of this section is to present the functionalities and demonstrate the effectiveness of the proposed system.

Figure 9.a and 9.b report respectively the graphical user interfaces (GUI) of the web and android applications and show some measurements of all sensor nodes under local environmental conditions. For the web application (figure 9.a), upper part shows the real-time analogue data for all sensors. Lower part shows the temporal trend of a chosen parameter. In the example shown in figure 9.a, CO₂ trend is presented. For the android application (figure 9.b), data are presented in two GUI: the first GUI shows the current value of all sensors while the second figure reports the temporal trend, e.g. CO₂ in this case. Note that both web-based and android application interfaces present, in real-time, the same safety status colour for each data type. The colour is “green” in this case to indicate that the monitored area is safe.

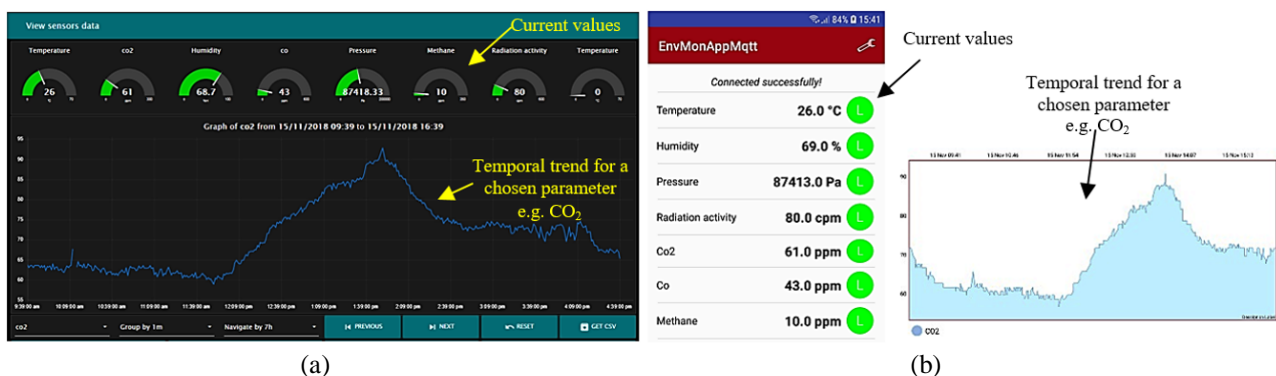

Fig. 9. (a) Web application, (b) android application showing some measurements under local environmental conditions

International Journal of Innovative Research in Science, Engineering and Technology

(A High Impact Factor, Monthly, Peer Reviewed Journal)

Visit: www.ijirset.com

Vol. 8, Issue 3, March 2019

The second experiment was performed to see the system's response when placed in a polluted environment. In this case, the experiment was conducted with smoke from burnt paper (figure 10.a). The results in figure 10.b and 10.c show the difference from initial condition. The safety status colour of CO₂ became red to indicate a danger when smoke is present.

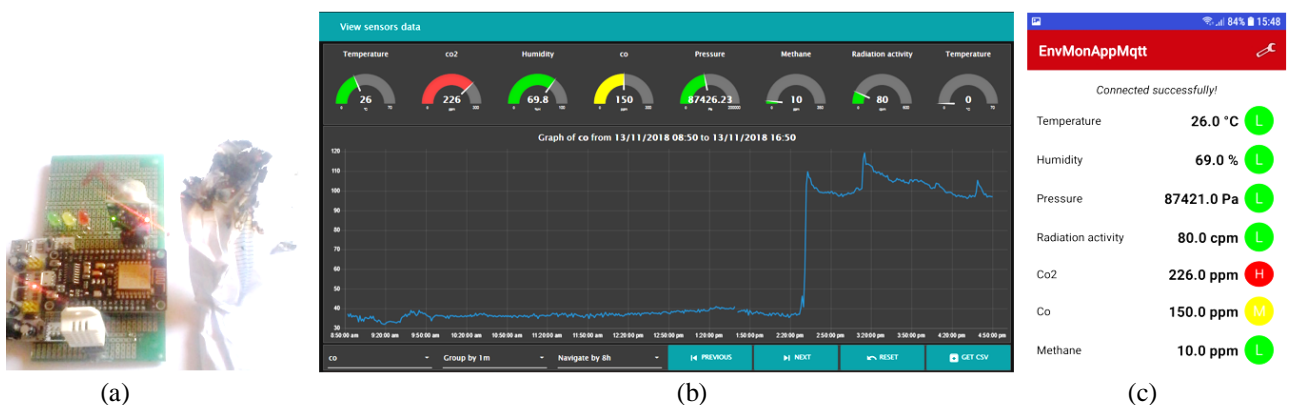

Fig. 10. (a) CO₂ sensor with smoke from burnt paper, (b) response of web application, (c) response of android application

Finally, figure 11.a and 11.b demonstrate that when radioactive source (Cs-137 in this case) was placed at a distance of 5cm from the ionizing radiation detector, the activity rate increased very quickly and the safety colour became red.

Figure 11.c shows the configuration interface of the android application from which the server and graph setting can be accessed and modified.

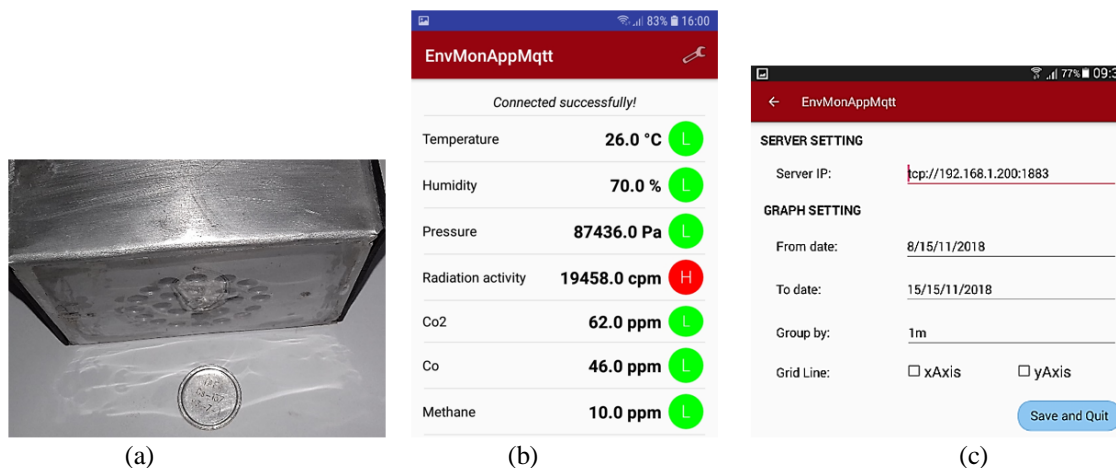

Fig. 11. (a) Cs-137 source positioned at 5cm from radiation detector, (b) GUI of the android application indicating danger of high activity rate, (c) Configuration interface of the android application.

At this stage, the system is not yet calibrated. Therefore, the device responses and results shown are qualitative ones. But it had been proved that the system respond to external environmental excitations and correctly transfers the information through the successive hardware and software.

International Journal of Innovative Research in Science, Engineering and Technology

(A High Impact Factor, Monthly, Peer Reviewed Journal)

Visit: www.ijirset.com

Vol. 8, Issue 3, March 2019

V. CONCLUSION

In this paper, an environmental and radiological monitoring platform using open-source hardware and software was developed and discussed. This prototype consisted of four sensor nodes, one server and web-based and android applications. Each sensor node was built with an ESP8266, a Wi-Fi-enabled Arduino compatible microcontroller, equipped with an air quality sensor or an ionizing radiation detector and was programmed with Arduino IDE to pre-process and transmit its data to a remote server using MQTT protocol. To receive, analyse/process, store and retransmit its data to remote computers, the server was running Mosquitto server for MQTT communication, Node-Red server for web service and InfluxDB server for time-series database management. Web-based and android applications that implement a graphical user interface have been developed to allow users to remotely monitor air quality and ionizing radiation exposure safety in real-time. The web and the android applications also allow users to customize some graph visualization parameters as well as to receive alarm warnings when one or more sensor data exceed threshold values. The system was designed to be easily scaled-up to measure other parameters of interest. The operation and effectiveness of the prototype were qualitatively tested and successfully evaluated under different environmental conditions.

Prospective step is to calibrate the system using reference protocols, and then assemble the components to have an operationalized instrument, useable in real environmental conditions.

ACKNOWLEDGEMENTS

The authors would like to thank the Madagascar Institute for Nuclear Sciences and Technologies (*INSTN-Madagascar*) for granting access to its facilities, for its financial support and contributions for the reported work. We also express our gratitude to the Department of Maintenance and Instrumentation team for their valuable efforts and contributions towards the successful completion of this research.

REFERENCES

- [1]. Mesay Magicho, "Internet of Things: Smart Home Device", Thesis - Metropolia University of Applied Sciences, 33 pages, mar. 2018
- [2]. A. Stankovic, "Research directions for the Internet of Things," IEEE Internet Things J., vol. 1, no. 1, pp. 3–9, Feb. 2014.
- [3]. Rawat, P.; Deep Singh, K.; Chaouchi, H.; Bonnin, J.M. Wireless sensor networks: A survey on recent developments and potential synergies. J. Supercomput. 2014, 68, 1–48.
- [4]. GitHub. "Arduino core for ESP8266 WiFi chip" <https://github.com/esp8266/Arduino>. Accessed: 2018
- [5]. Ratongasoandrazana Jean Baptiste, Raolina Andriambololona, Gérard Rambolamanana, Hery Andrianiaina, Rajaobelison Joël. Prototype of Remote Controlled Robot Vehicle to Scan Radioactive Contaminated Areas, IJRSET, Vol. 5, Issue 9, September 2016
- [6]. JS Foundation. "Node-RED Flow-based programming for the Internet of Things". <http://nodered.org/>. Accessed: 2018
- [7]. Eclipse.org. "Paho". <http://www.eclipse.org/paho/>. Accessed: 2018
- [8]. Aosong Electronics "Digital-output relative humidity & temperature sensor"
- [9]. Glenn F. Knoll, "Radiation Detection and Measurement", Fourth Edition, 2010.
- [10]. Paul Horowitz and Winfield Hill, "The Art Of Electronics" 2nd Edition,
- [11]. Arduino official website, <https://www.arduino.cc/>. Accessed: 2018
- [12]. Eclipse Mosquitto, An open source MQTT broker; <https://mosquitto.org/>. Accessed: 2018
- [13]. InfluxDB, a time series database management system; <https://www.influxdata.com/>. Accessed: 2018
- [14]. Android Studio, the official integrated development environment for Google's Android operating system; <https://developer.android.com/studio/>. Accessed: 2018
- [15]. MQTT, a machine-to-machine/Internet of Things connectivity protocol; <http://mqtt.org/>. Accessed: 2018
- [16]. V8, Google's open source high-performance JavaScript and WebAssembly engine; <https://v8.dev/>. Accessed: 2018
- [17]. Nyoman Putra Sastra, Dewa Made Wiharta; "Environmental Monitoring as an IoT Application in Building Smart Campus of Universitas Udayana" ICSGTEIS 2016.
- [18]. Kotipalli Manasa; "Monitoring and Analysing Air Pollution in the Atmosphere Using Smart Citizen Kit", IJRSET, Vol. 6, Issue 5, May 2017
- [19]. DHT11, DHT22 and AM2302 sensors, <https://learn.adafruit.com/dht/overview>. Accessed 2018.
- [20]. MQ Gas sensors, Using the MQ-2, MQ-3, MQ-4, MQ-5, MQ-6, MQ-7, etc. gas sensors. <https://playground.arduino.cc/Main/MQGasSensors>. Accessed 2018
- [21]. Geiger-Mueller (GM) Detectors – Pancake GM; <https://www.orau.org/ptp/collection/GMs/introgms.htm>; accessed 2018.
- [22]. BMP280 barometric pressure sensors; https://www.bosch-sensortec.com/bst/products/all_products/bmp280; accessed 2018.