

# Detection of Current Leakages in Industries Using IoT

V.Jaya sri<sup>1</sup>, V.Saritha<sup>2</sup>, G.Durga Srivani<sup>3</sup>, M.Indu Latha<sup>4</sup>, A.Chandra Suresh<sup>5</sup>

U.G. Student, Dept. of ECE, Sri Vasavi Institute of Engineering & Technology, Nandamuru, Pedana Mandal,  
Andhra Pradesh, India<sup>1,2,3,4</sup>

Associate Professor, Dept. of ECE, Sri Vasavi Institute of Engineering & Technology, Nandamuru, Pedana Mandal,  
Andhra Pradesh, India<sup>5</sup>

**ABSTRACT:** Day by day the productivity of industries is increasing in India. There is a good system is required to save the lives of the employees in the industries. In industrial a great chances are there to produce the current leakages. But the problem is the employees are owners never concentrate current leakages until anyone effected by current shocks. We can fix the current leakages but we unable to retrieve the human life's back. So in the project, we are proposing a continuous monitoring system that will always check current leakages in the cables with the help of Hall Sensor. Any current leakage happens from any electric cables that currently produce a strong magnetic field around the areas of the area. This magnetic field is easily detected by the Hall sensor. After detecting current leakage that will send to Raspberry pi. This processor generates Buzzer to alert the employees and also displays on LCD. This same information will be posted in the cloud with the location of the cable using IoT

**KEYWORDS:** Buzzer, Cloud, Hall Sensor, IoT, LCD, Raspberry Pi,

## I. INTRODUCTION

Technological developments have been taken to protect the lives of the employees in industries. What the monitoring systems now we are using is not sufficient to detect the current leakages in industries. The industry's environmental conditions have been upgrading day by day with this technology. By providing security to the human lives of employees they can easily work without any fear, consequently, the productivity of the industry will increases. In general, the industries monitor the temperature, humidity, and pressure. But nowadays all electronic gadgets can measure the temperature. In this project we proposing a method to measure and detect the current leakages in industries using hall sensors, raspberry pi with IoT. This technology will be more advanced and automatic as compared with existing methods. Internet of things As an emerging technology brought a new change in advanced wireless telecommunication, the Internet of Things (IoT) has attracted a lot of attention and is expected to bring benefits to numerous applications. The newly introduced concept of "Internet of Things" is providing a helping hand to achieve or tracking the environmental condition through remote access. In IoT, each device or device constituting a system will be able to communicate with the other devices or systems in the same premises over a common platform. Hence this leads to an exchange of relevant data, statistics, logs and various other parameters of the environment leads to an increase in the productivity of the system.

## II. EXISTING METHOD

Industries monitor is system is a method to log the environmental conditions in industries. In the present methods of the monitor, the system takes the data from various sensors and gives precautions. The Controller and controlling devices exchange data with RF communication, Zigbee and Bluetooth. The range of these technologies is very limited. We are unable to send this parameter to long distances. The ZigBee, RF, and Bluetooth wireless communication techniques are generally restricted to simple applications because of their slow communication speeds, distances, and data security. In existing methods that monitor parameters like temperature, humidity. These parameters are not sufficient to save the human lives of employees. If any current leakage occurs that can be detected after any huge risk happened to employ. Moreover, the present RF technologies are not sufficient to monitor the environmental conditions of industries. In this project, we have prosed a monitoring system that Able to detect the current leakages in cables with the help of hall sensors and cloud computing technologies.

III. PROPOSED METHOD

This project is primarily concerned with the security of the lives of employees in the industries. Detection of current leakages in the industries is done by a hall sensor. The hall sensor is placed near to cables which carry the current. The functionalities of the hall sensor are the piezoelectric effect. Any magnetic field is sensed at one side of the hall sensor and the second side of the sensor will generate the voltage. The Hall sensor has 3 pins. Vcc, GND, and a data pin. The Vcc and GND pins of the hall sensor are connected to respective pins of Raspberry pi. And the data pin is connected to 29. Whenever the current leak happened in the cable that leakage current produces a strong magnetic field. Because any current-carrying conductor produces strong magnetic around that conductor. The amount of magnetic field depends on the amount of current flowing through that conductor. Any current leakage happens that will be detected by the hall sensor and this sends to the raspberry pi. Now, this raspberry pi process this data and Buzzer will be on this data will be displayed on the LCD screen. The same information is posted in the cloud along with the location of the leak and its intensity of the magnetic field.

III A. *Block Diagram:* The Block diagram of the project is shown in Fig. 1

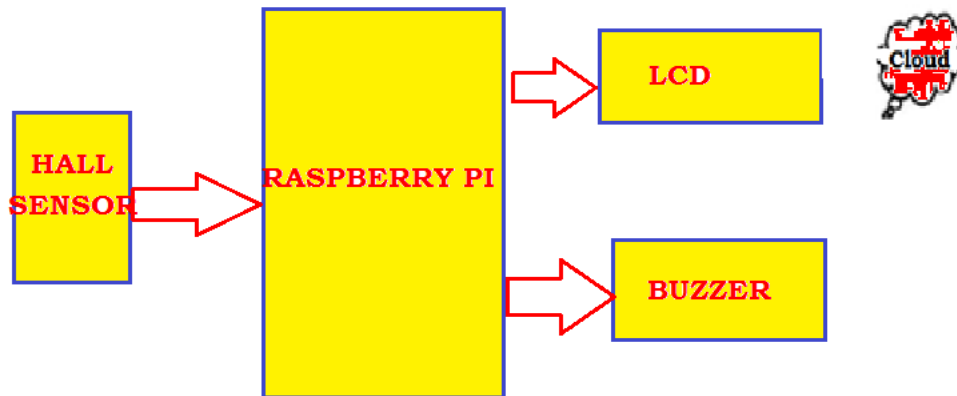

Fig.1: Block Diagram of the project

III B. *Overview of the project:*

In this project, we used raspberry pi as a central microcontroller for controlling the whole process of this project. The Hall sensor is used to detect the magnetic field. When the magnetic field is detected by the hall sensor on one side and another side the hall sensor generates the voltage. This voltage is applied to raspberry pi and that process and takes the necessary steps to save the lives of employees in industries. Here the reason to generate the magnetic field in the enjoyment of industries is leakage of currents in the wires. If any cable or wire gets damaged then it generates a magnetic field. This magnetic field can be detected and send to the microcontroller. This processor process this data and send it to IoT. And takes necessary actions like the buzzer on and displays this information on the LCD.

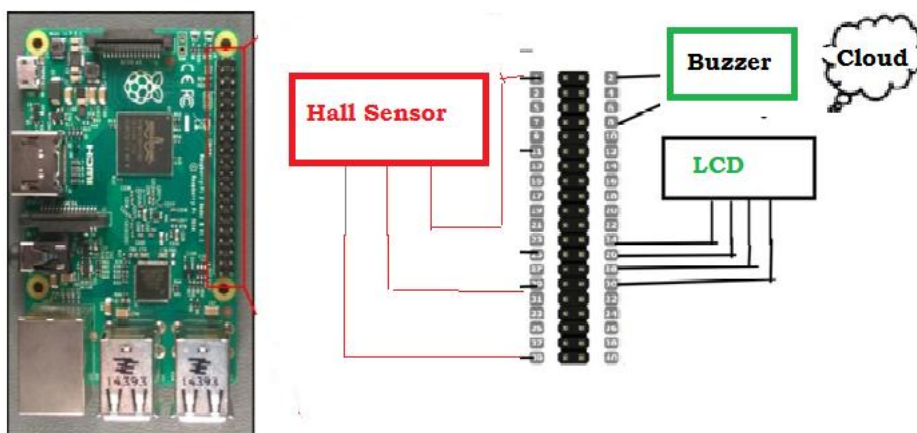

Fig.2: Schematic diagram of the project

III.C Flow of the project:

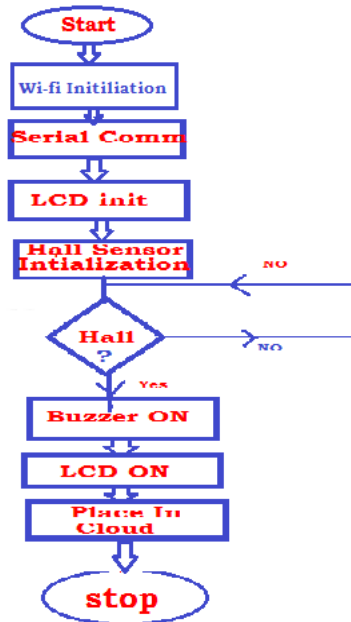

Fig.3: flow chart of the project

IV. HARDWARE DESCRIPTION

IV. A.Raspberry Pi

Raspberry pi is a series of small single-board computers built on a single circuit board, with microprocessors, memory, input/output and other features required of a functional computer) developed by the Raspberry Pi foundation. The 1st generation (Raspberry pi 1 model B) was released in Feb 2012, followed by the simpler and cheaper model A. Raspberry pi 3 model B is 29 February 2016. It has onboard Wi-Fi, Bluetooth and USB boot capabilities. All models feature a Broadcom system on chip (SoC) with an integrated ARM compatible CPU and on-chip graphics processing unit(GPU). The foundation provides Raspbian (OS for Raspberry pi) based Linux distribution for download, as well as third-party windows10 IoTcore RISC OS, and specialized media center distributions. It promotes Python and Scratch as the main programming languages.

IV. B.Pin Diagram of Raspberry Pi:

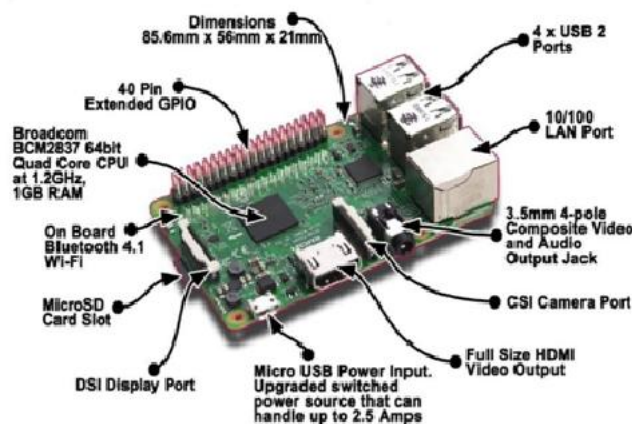

Fig.4: Pin diagram of Raspberry Pi

**IV. B.GPIO-General Purpose Input Output:**

Pin#	NAME		NAME	Pin#
01	3.3v DC Power		DC Power 5v	02
03	GPIO02 (SDA1 , I2C)		DC Power 5v	04
05	GPIO03 (SCL1 , I2C)		Ground	06
07	GPIO04 (GPIO_GCLK)		(TXD0) GPIO14	08
09	Ground		(RXD0) GPIO15	10
11	GPIO17 (GPIO_GEN0)		(GPIO_GEN1) GPIO18	12
13	GPIO27 (GPIO_GEN2)		Ground	14
15	GPIO22 (GPIO_GEN3)		(GPIO_GEN4) GPIO23	16
17	3.3v DC Power		(GPIO_GEN5) GPIO24	18
19	GPIO10 (SPI_MOSI)		Ground	20
21	GPIO09 (SPI_MISO)		(GPIO_GEN6) GPIO25	22
23	GPIO11 (SPI_CLK)		(SPI_CE0_N) GPIO08	24
25	Ground		(SPI_CE1_N) GPIO07	26
27	ID_SD (I2C ID EEPROM)		(I2C ID EEPROM) ID_SC	28
29	GPIO05		Ground	30
31	GPIO06		GPIO12	32
33	GPIO13		Ground	34
35	GPIO19		GPIO16	36
37	GPIO26		GPIO20	38
39	Ground		GPIO21	40

**Fig.5: GPIO diagram of Raspberry pi**

General-purpose input/output (GPIO) is a generic pin on an integrated circuit whose behavior, including whether it is an input or output pin, can be controlled by the user at run time. GPIO pins have no special purpose defined and go unused by default. The idea is that sometimes the system designer building a full system that uses the chip might find it useful to have a handful of additional digital control lines, and having these available from the chip can save the hassle of having to arrange additional circuitry to provide them.

GPIO Capabilities may include:

- ❖ GPIO pins can be configured to be input or output.
- ❖ GPIO pins can be enabled/disabled.
- ❖ Input values are readable (typically high=1,low=0).
- ❖ Output values are writable/readable.
- ❖ Input values can often be used as IRQs (typically for wakeup events).

**IV.C.Hall Sensor:**

Hall sensors convert magnetic or magnetically encoded information into electrical signals for processing by electronic circuits. Hall sensors are solid-state devices that are becoming more and more popular because they can be used in many different types of applications such as sensing position, velocity or directional movement. They are also a popular choice of sensor for the electronics designer due to their non-contact wear-free operation, their low maintenance, robust design and as sealed hall effect devices are immune to vibration,

Hall Sensors are devices that are activated by an external magnetic field. We know that a magnetic field has two important characteristics of flux density, (B) and polarity (North and South Poles). The output signal from a Hall effect sensor is the function of magnetic field density around the device. When the magnetic flux density around the sensor exceeds a certain pre-set threshold, the sensor detects it and generates an output voltage called the Hall Voltage,  $V_H$ .

The output voltage, called the Hall voltage, ( $V_H$ ) of the basic Hall Element is directly proportional to the strength of The output voltage  $V_H$  is directly proportional to the magnetic field passing through the semiconductor material). This output voltage can be quite small, only a few microvolts even when subjected to strong magnetic fields so most commercially available Hall effect devices

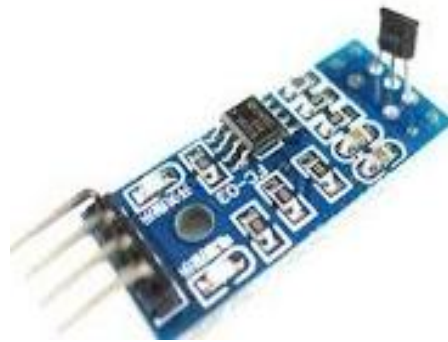

Fig. 6:Hall Sensor Module

**IV D Liquid Crystal Display:** The Liquid Crystal Display (LCD) is a low power device (microwatts). Nowadays in most applications LCDs are using rather using LED displays because of its specifications like low power consumption, It has 16 pins.LCD not only writes the it also reads data because it internally has one microcontroller. if RS=1, it receives the data and displays on LCD. The LCD not only receives data it also receives commands. when RS=0, it receives commands like screen clear and blink cursor like that.

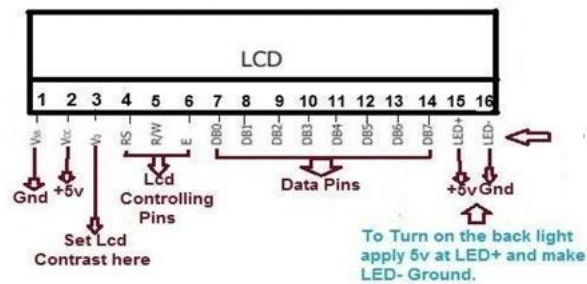

Fig. 7:LCD Pin diagram

## V. RESULTS

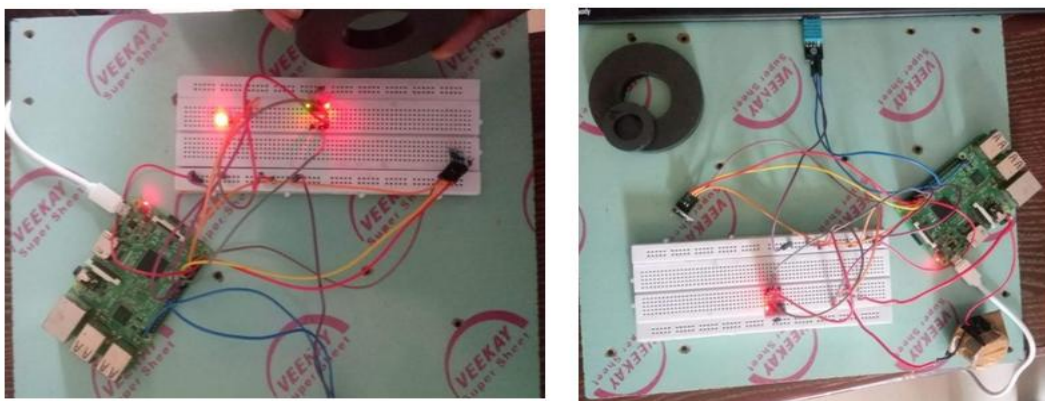

Fig. 8:Hardware Results of the project



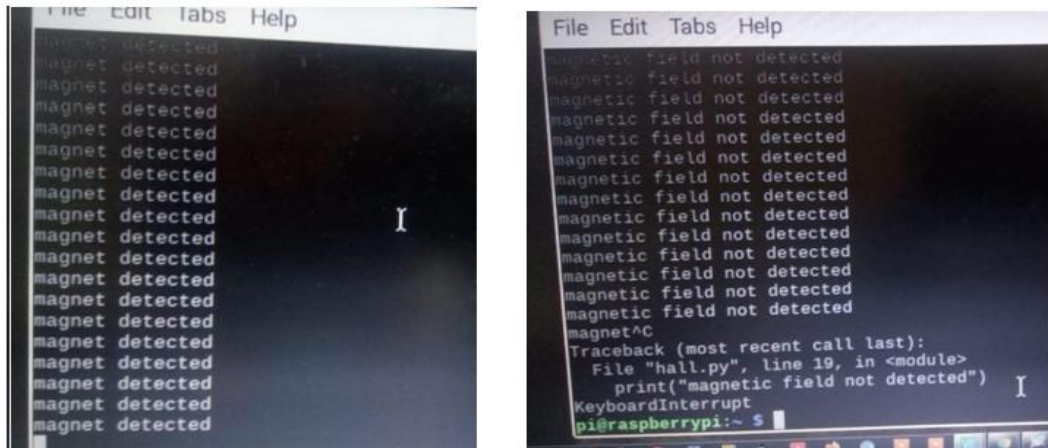

Fig. 9:Software Results of the project

## VI.CONCLUSION

This paper concludes that the present work was a success and it will provide a competent method for recording real-time current leakage readings and help the employees whose livelihood depends on the environmental conditions of industries. This circuit should be designed and also use IoT for wireless communication. IoT based monitoring system serves as a reliable and efficient system to efficiently monitor the environmental parameters. Wireless monitoring of the field which helps the user to reduce the human power and it also allows the user to see accurate changes in it.

## REFERENCES

- [1] Karthik Krishnamurthi, Suraj Thapa, Lokesh Kothari, Arun Prakash, "Arduino Based Weather Monitoring System", International Journal of Engineering Research and General Science Volume 3, Issue 2, March-April, 2015
- [2] Karishma Patil, Mansi Mhatre, Rashmi Govilkar, Shraddha Rokade, Prof.Gaurav Gawas, "Weather Monitoring using microcontroller", International Journal on Recent and Innovation Trends in Computing and Communication Volume 4 Issue1.
- [3] P.Susmitha, G.Sowmyabala, "Design and Implementation of Weather Monitoring and Controlling System", International Journal of Computer Applications Volume 97- No.3, July 2014.
- [4] Wei. Q, Jin. N, Lou X, Ma. R, Xu. J, "Software design for water environment remote monitoring system based on mobile devices", Applied Mechanics and Materials, pp. 2027-2032, 2011.
- [5] K. Krishnamurthi, S. Thapa, L. Kothari, A. Prakash, "Arduino Based Weather Monitoring System" International Journal of Engineering Research and General Science Volume 3, Issue 2, March, April 2015.
- [6] N. Sabharwal, R. Kumar, A. Thakur, J. Sharma "A Low-Cost Zigbee Based Automatic Wireless Weather Station With Gui And Web Hosting Facility" ICRTEDC, Vol. 1, Spl. Issue 2, May 2014.
- [7] N. Gahlot, V. Gundkal, S. Kothimbire, A. Thite, "Zigbee based weather monitoring system" The International Journal Of Engineering And Science (IJES), Volume 4, Issue 4, PP.61-66, 2015.
- [8] D-Robotics, UK, DHT11 Humidity & Temperature Sensor datasheet. [online]. Available: <https://www.droboticsonline.com>, (30/Jul/2010).

## BIOGRAPHY



**V. Jaya Sri** is pursuing B. Tech in the Department of Electronics and Communication Engineering from Sri Vasavi Institute of Engineering & Technology, Nandamuru, Pedana Mandal, Krishna District, Andhra Pradesh, India. Her research area of interest is Embedded Systems and IoT



**V. Saritha** is pursuing B. Tech in the Department of Electronics and Communication Engineering from Sri Vasavi Institute of Engineering & Technology, Nandamuru, Pedana Mandal, Krishna District, Andhra Pradesh, India. Her research area of interest is Embedded Systems and IoT.



**G.Durga Srivani** is pursuing B. Tech in the Department of Electronics and Communication Engineering from Sri Vasavi Institute of Engineering & Technology, Nandamuru, Pedana Mandal, Krishna District, Andhra Pradesh, India. Her research area of interest is Embedded Systems and IoT



**M.Indu Latha** is pursuing B. Tech in the Department of Electronics and Communication Engineering from Sri Vasavi Institute of Engineering & Technology, Nandamuru, Pedana Mandal, Krishna District, Andhra Pradesh, India. Her research area of interest is Embedded Systems and IoT



**A. Chandra Suresh** is currently working as an Associate professor in Sri Vasavi Institute of Engineering & Technology. He has 13 years of teaching experience and 2 years of industrial experience. He received his B.Tech from JNTU College of engineering Ananthapur. And M.Tech degree from Jawaharlal Nehru technological university Kakinada. He is a life member of ISTE and IAENG. His research area of Interest is an Embedded system, Cloud computing, and IoT.