

International Journal of Innovative Research in Science, Engineering and Technology

(A High Impact Factor, Monthly, Peer Reviewed Journal)

Visit: www.ijirset.com

Vol. 9, Issue 1, January 2020

Mechatronics, Identification Technology, Industry 4.0 and Education

MOHAMED ABDUL NASEER. R

Lecturer, Dept. of Mechanical Engineering, S.S.M.Polytechnic College, Tirur, Thekkumuri, Kerala, India

ABSTRACT: It's easy to notice the impact of technological improvements on computing infrastructure, which is always evolving. It has a major impact on the introduction of the idea of Industry 4.0 in the disciplines of Mechatronics and Identification technology. It is possible to overcome this disparity in educational and production/services processes by constantly developing curricula, with a special focus on the adoption of identification technologies as one of the primary elements of Industry 4.0. The goal of the initiative is transformation of industrial manufacturing through digitalization and exploitation of potentials of new technologies. An Industry 4.0 production system is thus flexible and enables Individualized and customized products. Many companies, research centers, and universities acknowledge that robotics and automation technology is the basis of industrial manufacturing and an important driver for Industry 4.0. The current status of Industry 4.0 readiness of the German companies is presented and commented. Finally it is discussed if Industry 4.0 is really a disruptive concept or simply a natural incremental development of industrial production systems. Mechatronics is an interdisciplinary field that integrates mechanical engineering, electronics and computer science. Although the word mechatronics has been in use for some forty years, great strides have been made in its applications over the last twelve years, and this can be widely seen in consumer products around us. Automobiles, washing machines, digital cameras and robots are main examples of mechatronic systems.

KEYWORDS: Mechatronics, Industry 4.0, Technology, Education, Mechatronic Process, Evolution of industry 4.0.

I. INTRODUCTION

As an integrated digital manufacturing environment, the advent of Industry 4 is a new research perspective that has pushed the field toward interdisciplinarity and the use of ICT breakthroughs. Industry 4.0 and the creation of the smart factory as a result of integrating intelligence into industrial processes are the focus of this study. It gives a quick overview of the key elements of Industry 4.0 and focuses on the security problems and threats that the ecosystem's fully integrated ecosystem faces. [1] In order to protect the confidentiality and integrity of the information transferred among the Industry 4.0 components, the primary research directions for maintaining security are outlined. Another perspective is that of the security concerns that arise when new technology are made available.

Tetsura Mori, a prominent Japanese engineer, coined the term "mechatronics" in 1969, and the discipline has been considered to have developed out of robotics. Roboarms had no sensory feedback or coordination when they first appeared, but this has improved over time thanks to advancements in programmability, sensor technology, and control. Mechanical, electrical and electronic control and automation, and computer engineering are all part of Mechatronics. [2]

It is the primary research goal of mechatronics to design and control advanced hybrid systems that span all of these domains, supported by multidisciplinary studies. A number of new technologies have arisen, allowing designers to completely rethink their approach. Ideas that couldn't be implemented a decade ago have been rethought and mechatronic design methodologies are now being evaluated. [3] The difficulties of successfully implementing increasingly complex mechatronic systems increase in tandem with their complexity.

International Journal of Innovative Research in Science, Engineering and Technology

(A High Impact Factor, Monthly, Peer Reviewed Journal)

Visit: www.ijirset.com

Vol. 9, Issue 1, January 2020

In order to produce higher-quality goods at lower costs, Industry 4.0 will make it possible to collect and evaluate data from multiple equipment. Manufacturing productivity will rise as a result, economics will alter, industrial growth will pick up steam, and the labour profile will shift, all of which will have an impact on the competitiveness of enterprises and regions. [4]

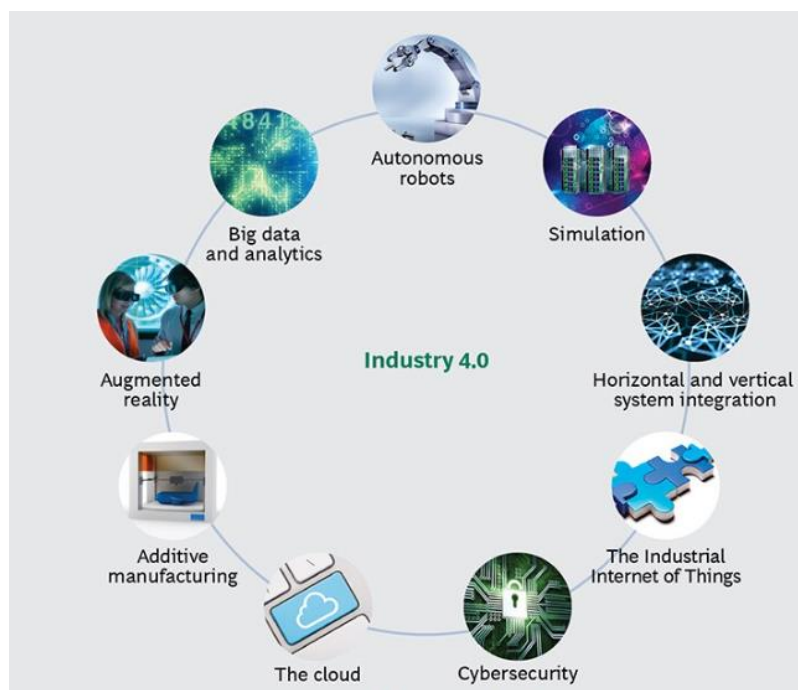

Fig. 1 Industry 4.0 is the vision of the industrial production of the future

To summarise I4.0's most important features, we'll use the formula below.

- **Interoperability**
People and smart factories can communicate and link via cyber-physical systems (such as workpiece transporters, assembly stations, and finished goods).
- **Virtualization**
Through the use of sensor data, virtual plant models, and simulation models, an exact replica of the smart factory may be built virtually on a computer screen.
- **Decentralization**
The decisions of cyber-physical systems are made autonomously, and they create locally (by using 3D).
- **Real-time capability**
Instantaneous access to the results of data collecting and analysis.
- **Service orientation.**
- **Modularity**
Individual modules can be replaced or expanded to allow smart factories to adapt to changing needs.
- **Convergence.**
- **Cost reduction and efficiency.**

International Journal of Innovative Research in Science, Engineering and Technology

(A High Impact Factor, Monthly, Peer Reviewed Journal)

Visit: www.ijirset.com

Vol. 9, Issue 1, January 2020

- Mass customization.

Educational trends related to Industry 4.0

Several contemporary educational trends must be taken into account while developing the specialised skills necessary for Industry 4.0 technologies that educational systems must supply to its graduates. Incorporating new technologies, tools, and resources, such as mobile engineering laboratories and project- and problem-based learning, as well as experiential and collaborative learning, as well as student involvement in curriculum development, are just a few of the trends we're seeing in education today. [5] In the design phase of the SEPT Learning Factory, these trends were considered and their implementation will be documented in a forthcoming article.

Current state of industry 4.0 in india

India has to move from manufacturing outfits of Industry 1.0 and 2.0 to Industry 4.0 and beyond. EEPC India in association of Department of Heavy industries (DHI) is raising awareness on the 4th Industrial Revolution to drive the Indian manufacturing to a 'Smart and intelligent Manufacturing' Hub said Mr. Ravi Sehgal at a Industry 4.0 session .

Indian Engineering Exports have been growing at a rate of 10% with variation, but the Engineering Exports as a percentage of ASEAN and World Exports is stagnating at 0.8-1 % over the last 10-15 years. This is because majority of engineering goods originated from low or middle level products. Department of Commerce, Ministry of Commerce and Industry has given to this apex engineering body a mandate to incarnate a Technology Centre to enable MSMEs to benefit from various new technologies. India also needs to close a quality gap faced with the best in class, and leapfrogging to newer technologies, will enable quality export products, hence EEPC India Technology Centre gains ground.[6]

EEPC India Technology Centre in Bengaluru and also the one would be opened shortly in Kolkata , with a view to develop export product by providing a forum for Industry and Academia discussion and learning" Mr. Sehgal said at the seminar. It was a day long productive session where eminent speakers from DHI, IIT Kharagpur, ISI-Kolkata; CMERI- Durgapur; CMTI, C4i4 Pune motivated the stakeholders on the theme

Characteristics of Industry 4.0

Industry 4.0 is the future of global manufacturing. It is the era of automation, of the digitalized factory and digitalized products – the fourth phase of industrial revolution, or Industry 4.0. Nevertheless, the academics field is still unable to define the approach as the Industry 4.0 is the basic term referring to the fourth industrial revolution. [7]

International Journal of Innovative Research in Science, Engineering and Technology

(A High Impact Factor, Monthly, Peer Reviewed Journal)

Visit: www.ijirset.com

Vol. 9, Issue 1, January 2020

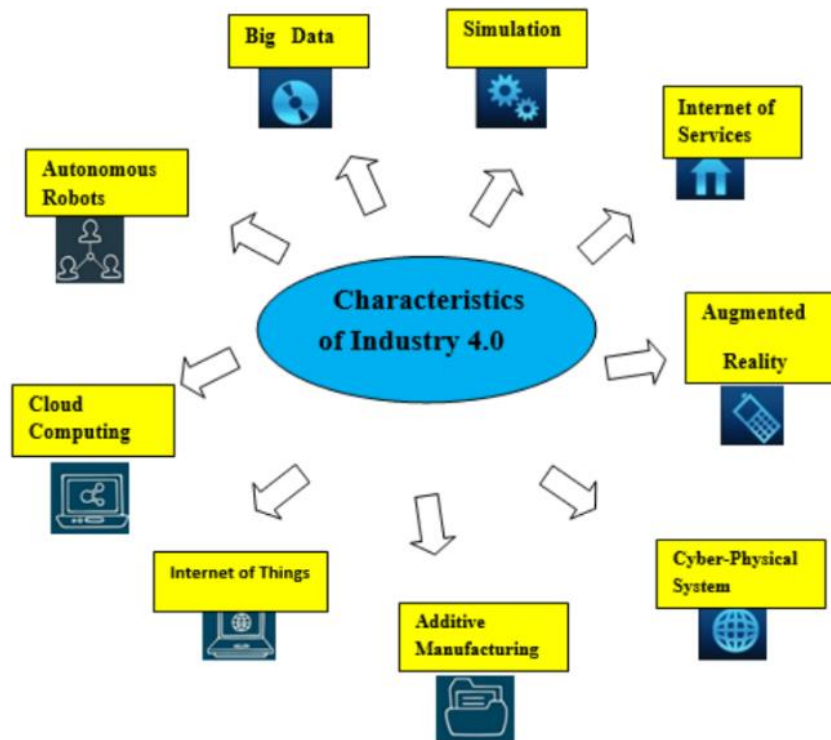

Fig. Characteristics of Industry 4.0.

This causes difficulty to distinguish its components. There are 9 characteristics for industry as shown in Figure 2 below.

Opportunities

- Economic gains, such as increased revenues because of lower transaction and transportation costs.
- Higher quality products as a result of real-time monitoring.
- Enhanced productivity through optimization and automation.
- Eliminate human dependency.
- Shift to mass customization.
- Enabling innovation across many applications, with a much larger economic impact on growth.
- Energy-efficient and environmentally sustainable production and systems.
- Effective use of human resources and materials.
- Increased food security and safety.
- Improvements in the health and safety of workers.
- Changes in education and training systems.
- More open innovation systems.
- Predictive and Remote maintenance.[8]

International Journal of Innovative Research in Science, Engineering and Technology

(A High Impact Factor, Monthly, Peer Reviewed Journal)

Visit: www.ijirset.com

Vol. 9, Issue 1, January 2020

Challenges

- Change management, something which is too often overlooked.
- Examination and Review of company culture.
- Proper interconnection of all departments of the organization
- Recruitment and development of the new talents.
- Cyber security.
- Huge initial Investments.
- Collaboration.
- IT modernization.
- Infrastructure gaps.
- Continuous learning and on-the-job training.
- Outdated international rules and regulations.
- Data ownership and security.
- Reliability and stability of CPSs.
- Transparency, privacy, ethics and security

Mechatronics: an overview

Mechatronics is concerned with the integration of its core technologies to generate new and novel technological solutions in the form of products and systems in which functionality is integrated across these core technologies, with information technology and software engineering providing the 'glue' which binds the whole together. This integration is also reflected in various diagrammatic forms that have been used to represent the structure of a mechatronic system.[9]

Mechatronics applications and fields

Nowadays, mechatronic systems and technology are available everywhere around us; starting from simple household items like microwave ovens, toasters, and modern refrigerators; office equipment like computer mice, card readers and communications devices; in almost all forms of transportation hardware, like modern electronic car keys, active suspension systems, and engine control (along with other computer controlled car peripherals); to even our own personal communications systems, i.e. the mobile or smart phone. These are some of the devices and applications that the mechatronics approach has been able to improve. However, there are two main areas where mechatronics has impacted the most and revealed its enormous potential. These are in the machine tools industry and in robotics applications.[10]

International Journal of Innovative Research in Science, Engineering and Technology

(A High Impact Factor, Monthly, Peer Reviewed Journal)

Visit: www.ijirset.com

Vol. 9, Issue 1, January 2020

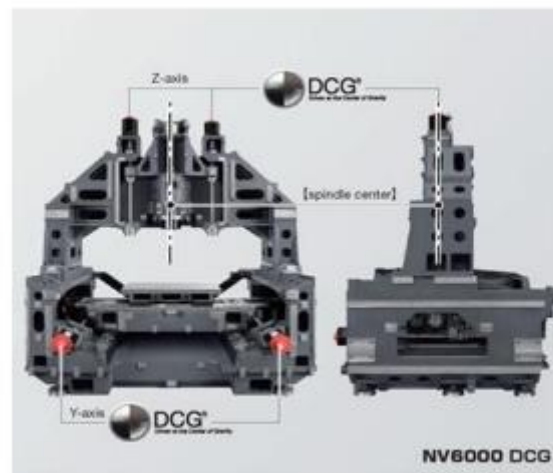

Fig. High-Precision Vertical Machining Center.

Figure 3 shows a state of the art machine tool, fully utilizing every ounce of potential that mechatronics can provide. From the control of the spindle, to the machine stability provided by DCG®, this machine tool and other similar ones in industry is the epitome of mechatronic design. In robotics, mechatronic design and concepts are at the heart of every functional precision and high performance robot.



Fig. Modern Industrial Robot.

No matter what application the robot is designed for, a precise and complex execution of motor rotation, sensor sampling and at times hydraulic actuation is a must that only mechatronic technology can bring into reality. Figure 4 shows a modern robot typically used for industrial purposes.[11]

International Journal of Innovative Research in Science, Engineering and Technology

(A High Impact Factor, Monthly, Peer Reviewed Journal)

Visit: www.ijirset.com

Vol. 9, Issue 1, January 2020

II. REVIEW OF LITERATURE

Miatliuk et.al, 2010 [12] suggests a mechanism for using new information technology in mechatronic systems design. Traditional mathematical models do not allow mechatronic systems to be described at all levels on common formal basis. They do not describe the structure of systems (the set of dynamic subsystems with their interactions), the system as a dynamic unit in its environment, and the environment itself.

Shetty et.al, 2012 [13] shows the simulation based mechatronic model of a complex system with a better understanding of the dynamic behavior and interactions of the components. This offers improved possibilities of evaluating and optimizing the dynamic motion performance of the entire automated system in the early stages of the design process. Another effect is the growing influence of interactions between machine components on achievable machine dynamics and precision and quality of components.

P. Hehenberger 2014 [14] gives an overview of hierarchical modeling techniques which helps to describe product models and data from different viewpoints that, representing the different disciplines involved in the design process of mechatronic systems.

Zheng et.al, 2016 [15] presents a multidisciplinary interface model for design of mechatronic systems in order to enable the multidisciplinary integration among design team members from different disciplines. On the one hand, the proposed model ensures the consistency of interface defined by the designers. On the other hand, it helps the designers to guarantee the different components integrate correctly. The interface model including three concepts: classification, data model and compatibility rules.

V.C. Moulianitis, et.al, 2018 [16] proposed a new mechatronics index for the evaluation of the alternatives in the conceptual design phase. The criteria aggregated to the index are acquired mostly by the collective knowledge presented in the Multi Annual Roadmap for robotics in Europe and adapted by considering the recent advancements in mechatronics.

In simple words, Industry 4.0 is the other name of digital transformation of the manufacturing operations like production, information sharing, and other value creation process. Cyber-physical systems, for example, smart machines, form the basics of Industry 4.0. Cyber-physical systems are used as control systems for tracking different business activities related to the manufacturing and other value creation process (Nikolic et al., 2017). [17]

The production activities of different organizations have been affected badly as most of the organizations have been forced to manage their productions with minimum number of workers in the factories during the lockdowns intended for controlling the spread of corona virus. The production rate of many small organizations has been decreased during the lockdown periods (Fatorachian and Kazemi, 2018)[18]

Objectives

- To study mechatronic design
- To study mechatronic Process
- To study evolution of industry 4.0
- To study key components of Industry 4.0.

International Journal of Innovative Research in Science, Engineering and Technology

(A High Impact Factor, Monthly, Peer Reviewed Journal)

Visit: www.ijirset.com

Vol. 9, Issue 1, January 2020

III. RESEARCH METHODOLOGY

The design of a research project Qualitative research methods such as in-depth interviews, on-site observations, and document analysis were used in this study. Qualitative research conveys a story rather than analysing the cause and impact of a situation or phenomena. It is necessary to do extensive study into secondary sources in order to use analytical and descriptive methods. Close reading of a few secondary materials would be necessary to expand the textual analysis and provide additional perspectives.

IV. RESULT AND DISCUSSION

The main pros and cons of I4.0

Advantages	Disadvantages
Strategic competitive advantage	The negative impact of data sharing in a competitive environment
Organizational efficiency and effectiveness	Total implementation of industry 4.0 is necessary for the success
Organization agility	Handling employees and trade unions apprehensions
Manufacturing innovation	Need for highly skilled labor
Profitability	Socio-technical implications of industry 4.0
Improved product safety and quality	Cybersecurity
Delightful customer experience	High initial cost
Improved operations	
Environment and social benefits	

Table 1 mentions the main pros and cons, of I4.0

In Fig 2, you can see the most important parts of I4.0. As a result, each of them is examined in terms of its potential impact on the organization's security. [19]

International Journal of Innovative Research in Science, Engineering and Technology

(A High Impact Factor, Monthly, Peer Reviewed Journal)

Visit: www.ijirset.com

Vol. 9, Issue 1, January 2020

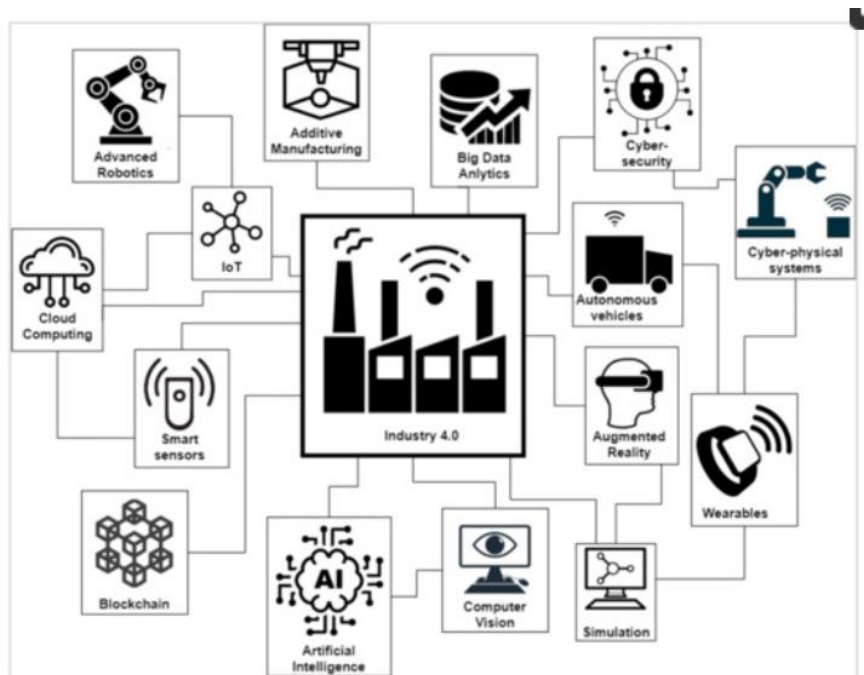

Fig. 2 Key components of Industry 4.0.

In Fig 2, you can see the most important parts of I4.0. Each one is thoroughly examined, with particular attention paid to the security concerns that may occur as a result of implementing a particular technology. [20]

Both "Industry 4.0" and "Smart manufacturing" have a great deal of sway across borders. Currently, academics and practitioners in the 4th Industrial Revolution are debating these issues to no end. [21]

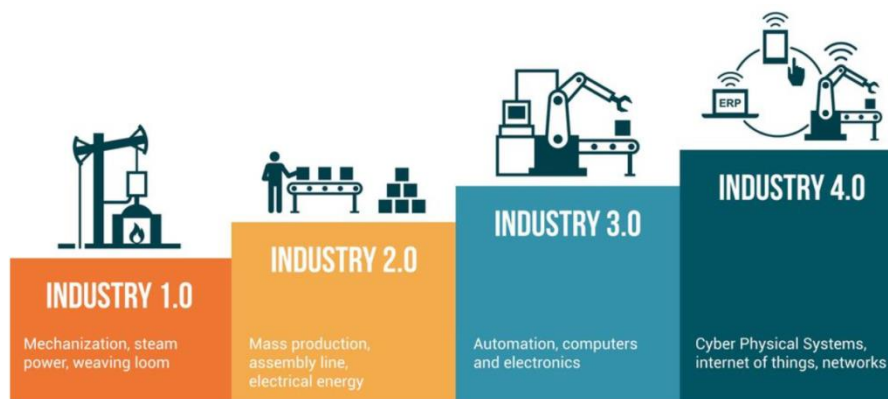

Fig. 3 Evolution of industry 4.0

International Journal of Innovative Research in Science, Engineering and Technology

(A High Impact Factor, Monthly, Peer Reviewed Journal)

Visit: www.ijirset.com

Vol. 9, Issue 1, January 2020

An organization's digital transformation can be compared to the evolution of industry 4.0. Factory 4.0 (Innovation + Industry + Economy): what you need to know. This includes the digitization of the value chain as well as product and service offerings. [22]

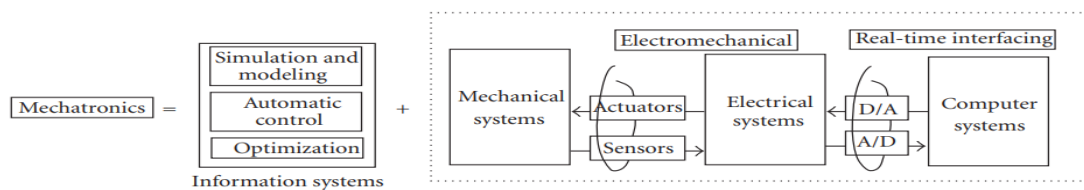

Fig. 4 Mechatronic Process

As indicated in Fig 4, a Mechatronic design philosophy is an integrated approach to engineering design.

Fig. 5 depicts a typical mechatronic design process (see also reference 14). It is possible to use software tools to assist a designer in building and debugging mathematical system models starting with stages 5 through 9.[23-24]

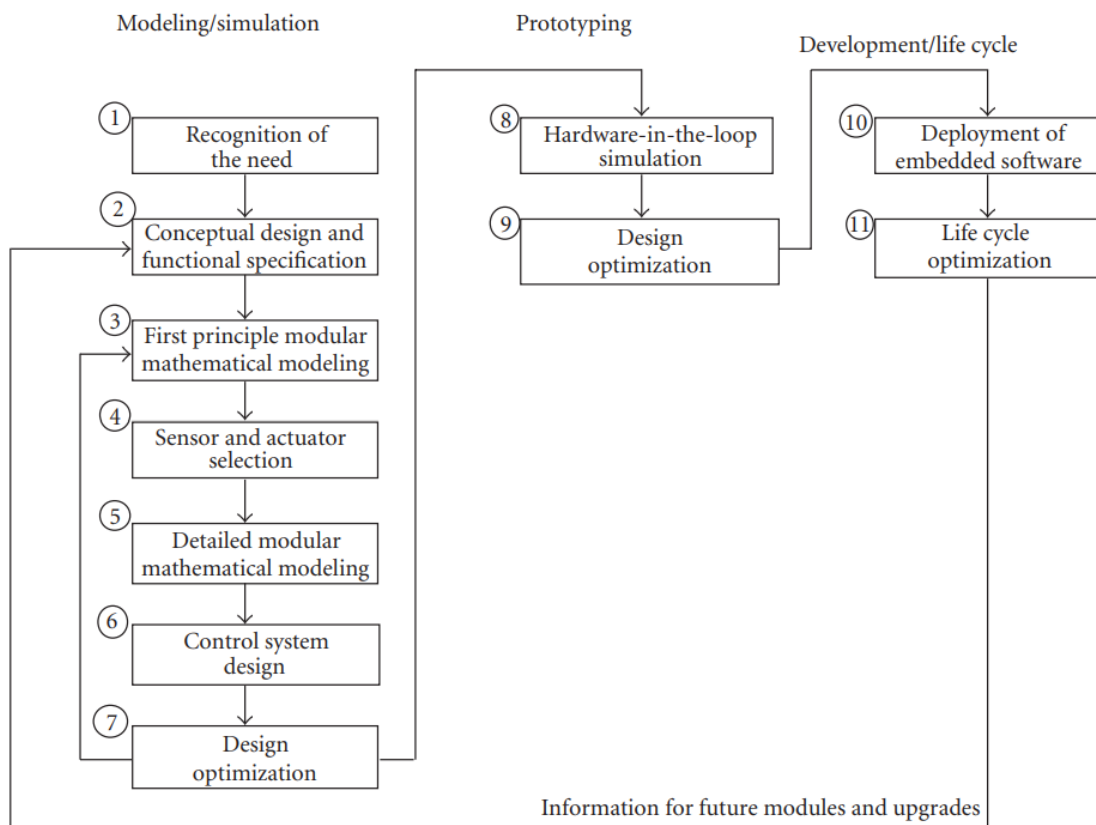

Fig. 5 Mechatronic design

International Journal of Innovative Research in Science, Engineering and Technology

(A High Impact Factor, Monthly, Peer Reviewed Journal)

Visit: www.ijirset.com

Vol. 9, Issue 1, January 2020

Designers can create a system block diagram using simple building blocks like integrators, gain stages, summing junctions, and nonlinear switches, which are particularly useful. [25]

VI. CONCLUSION

Future product development processes will necessitate better methodologies due to the increased demands on machine tool productivity and the increasing technological sophistication of such instruments. I4.0 is a concept that is presently being developed and has the potential to dramatically improve the quality of our lives in several ways while also preparing society for a wide range of changes that may come soon or in the future. As a result, society needs to be prepared for the possible changes that I4.0 will bring. Industry 4.0 describes a future scenario of industrial production that is characterized by the aspects of a new level of controlling, organizing and transforming the entire value chain with the life cycle of products, resulting in higher productivity and flexibility through three types of effective integration which are horizontal, vertical and end-to-end engineering integration. Hence, these can predict product performance degradation and autonomously manage and optimize product service needs and consumption of resources which lead to optimization and reduction of costs. Next, the creation of dynamic, real-time optimized and self-organizing cross-company value networks through the Cyber-Physical Systems (CPS), Internet of Things (IoT), artificial intelligence (AI), additive manufacturing, cloud computing and others are added. Mechatronics encompasses broad areas of inter-disciplinary knowledge. Improving the way we live and the products we use is not limited by the boundaries of traditional disciplines. With the ever-changing requirements and needs of a sophisticated and complex world, technologies and innovations must advance at a very fast pace to keep in tandem. In the future, mechatronics will play a significant role on improving the reliability, safety, and affordability of products.

REFERENCES

1. Lee, J.; Bagheri, B.; Kao, H.-A. A Cyber-Physical Systems Architecture for Industry 4.0-Based Manufacturing Systems. *SME Manuf. Lett.* 2014, 3, 18–23
2. Ibarra-Esquer, J.; González-Navarro, F.; Flores-Rios, B.; Burtseva, L.; Astorga-Vargas, M. Tracking the Evolution of the Internet of Things Concept Across Different Application Domains. *Sensors* 2017, 17, 1379.
3. Chatzigiannakis, I.; Liagkou, V.; Spirakis, P.G. Brief Announcement: Providing End-to-End Secure Communication in Low-Power Wide Area Networks. In *Proceedings of the Cyber Security Cryptography and Machine Learning (CSCML 2018)*, Beer Sheva, Israel, 21–22 June 2018; pp. 101–104.
4. Liu, Y.; Xu, X. Industry 4.0 and Cloud Manufacturing: A Comparative Analysis. *J. Manuf. Sci. Eng.* 2017, 139, 034701.
5. Camenisch, J.; Lysyanskaya, A. *Signature Schemes and Anonymous Credentials from Bilinear Maps*; Springer: Berlin/Heidelberg, Germany, 2004; pp. 56–72.
6. Zheng, P.; Wang, H.; Sang, Z.; Zhong, R.; Liu, Y.; Liu, C.; Mubarak, K.; Yu, S.; Xu, X. Smart Manufacturing Systems for Industry 4.0: Conceptual Framework, Scenarios, and Future Perspectives. *Front. Mech. Eng.* 2018, 13, 137–150.
7. L. Merkel, J. Atug, L. Merhar, C. Schultz, S. Braunreuther, G. Reinhart, Teaching smart production: an insight into the Learning Factory for Cyber-Physical Production Systems (LVP), *Procedia Manufacturing*, 9 (2017) 269-274
8. S. Thiede, M. Juraschek, C. Herrmann, Implementing cyber-physical production systems in learning factories, *Procedia CIRP*, 7 (2013) 17-24
9. E. Abele, G. Chryssolouris, W. Sihn, J. Metternich, H. ElMaraghy, G. Seliger, G. Sivard, W. ElMaraghy, V. Hummel, M. Tisch, S. Seifermann, Learning factories for future oriented research and education in manufacturing, *CIRP Annals*, 66(2) 803-826

International Journal of Innovative Research in Science, Engineering and Technology

(A High Impact Factor, Monthly, Peer Reviewed Journal)

Visit: www.ijirset.com

Vol. 9, Issue 1, January 2020

10. M. Tisch, C. Hertle, J. Cachay, E. Abele, J. Metternich, R. Tenberg, A systematic approach on developing action-oriented, competency-based learning factories, *Procedia CIRP*, 7 (2013) 580-585.
11. Wübbecke, J.; Meissner, M.; Zenglein, M.J.; Ives, J.; Conrad, B. Made in China 2025. Mercator Inst. China Stud. Pap. China 2016, 2, 74.
12. Habchi&Barthod, An overall methodology for reliability prediction of mechatronic systems design with industrial application, *Science Direct, Reliability Engineering and System Safety*155(2016)236–254
13. Devdas Shetty, LouManziona, and Ahad Ali, Survey of Mechatronic Techniques in Modern Machine Design, Hindawi Publishing Corporation, *Journal of Robotics*, Volume 2012, Article ID 932305, 9 pages
14. P. Hehenberger, Perspectives on hierarchical modeling in mechatronic design, *Science Direct, Advanced Engineering Informatics* 28 (2014) 188–197
15. Chen Zheng, Julien Le Duigou, Matthieu Bricogne, Benoît Eynard, Multidisciplinary interface model for design of mechatronic systems, *Science Direct, Computers in Industry* 76 (2016) 24–37
16. V.C. Moulianitis, G.-A.D. Zachiotis, N.A. Aspragathos, A new index based on mechatronics abilities for the conceptual design evaluation, *Science Direct, Mechatronics* 49 (2018) 67–76
17. Nikolic, B., Ignjatic, J., Suzic, N., Stevanov, B. and Rikalovic, A., 2017. PREDICTIVE MANUFACTURING SYSTEMS IN INDUSTRY 4.0: TRENDS, BENEFITS AND CHALLENGES. *Annals of DAAAM & Proceedings*, 28.
18. Fatorachian, H. and Kazemi, H., 2018. A critical investigation of Industry 4.0 in manufacturing: theoretical operationalisation framework. *Production Planning & Control*, 29(8), pp.633-644
19. Zheng, P.; Wang, H.; Sang, Z.; Zhong, R.; Liu, Y.; Liu, C.; Mubarak, K.; Yu, S.; Xu, X. Smart Manufacturing Systems for Industry 4.0: Conceptual Framework, Scenarios, and Future Perspectives. *Front. Mech. Eng.* 2018, 13, 137–150.
20. Bernard Marr (2018), What is Industry 4.0? Here's A Super Easy Explanation For Anyone, at <https://www.forbes.com/sites/bernard-marr/2018/09/02/what-is-industry-4-0-heres-a-super-easy-explanation-for-anyone/#799c09109788>.
21. Renesas (2015), Industry 4.0 - The Next Industrial Revolution?, at <https://www.eeweb.com/blog/renesas/industry-4.0-the-next-industrial-revolution>.
22. Richard E. Crandall (2017), Industry 1.0 to 4.0: the Evolution of Smart Factories, at <http://www.apics.org/apics-for-individuals/apics-magazine-home/magazine-detail-page/2017/09/20/industry-1.0-to-4.0-the-evolution-of-smart-factories>, Accessed on: 2019/11/12
23. Dilberoglu, U. M., Gharehpapagh, B., Yaman, U. and Dolen, M.. The role of additive manufacturing in the era of Industry 4.0. *Procedia Manufacturing* 11 (2) (2017) 545–554.
24. European Factories of the Future Research Association – EFFRA. Factories of the future: multi-annual roadmap for the contractual PPP under Horizon2020: report. Brussels: EFFRA, 2013.
25. Foresight. The Future of Manufacturing: A New Era of Opportunity and Challenge for the UK. London: UK Government Office for Science, 2013. Gorecky, D., Schmitt, M., Loskyll, M. and Zühlke, D. Human-Machine-Interaction in the Industry 4.0 Era. 12th IEEE International Conference on Industrial Informatic, 2014, 289–294.