



e-ISSN: 2319-8753 | p-ISSN: 2347-6710

IJRSET

International Journal of Innovative Research in
SCIENCE | ENGINEERING | TECHNOLOGY

A hand is shown from the bottom, holding a glowing, realistic Earth globe. The background is a dark blue digital interface with various data visualizations, including bar charts, line graphs, and world maps. Text elements like 'BUSINESS', 'NETWORK SEARCH', and 'LADING 100%' are visible on the interface.

INTERNATIONAL JOURNAL OF INNOVATIVE RESEARCH

IN SCIENCE | ENGINEERING | TECHNOLOGY

Volume 10, Special Issue 3, December 2021

ISSN INTERNATIONAL
STANDARD
SERIAL
NUMBER
INDIA

Impact Factor: 7.569

9940 572 462

6381 907 438

ijirset@gmail.com

www.ijirset.com

Fault Analysis and Power Quality Detection in Transmission Lines

Abdul Rahuf P, Daison Sebastian, Majida Shirin M, Irshad K P, Kiran P*

Department of Electrical and Electronics Engineering, Royal College of Engineering and Technology, Thrissur, Kerala, India

ABSTRACT: Transmission lines are essential links for transmission of electric power in power systems. The chances of occurrence of faults in transmission line are very high as they are exposed to atmosphere. The performance of power system is affected by the faults on transmission lines, which result in interruption of power flow. Fault detection and classification is essential for determining the location of the fault which helps in maintenance and restoration of supply, resulting in reliability of power supply and improved economy. A fault occurs when two or more conductors come in contact with each other or one or more conductors come in contact with ground. Faults which occur on transmission lines not only effect the equipment but also the power quality. Electric Power Quality (PQ) is a very important issue as far as the power supply utilization is concerned. It is the measure of electric power supply quality reached to the customer end for their specific utilization. This paper presents a technique to detect and classify the different types of faults and power quality disturbance in transmission lines using wavelet transform. The most important characteristic of wavelet transform is to analyze the waveform on time-scale rather than frequency.

I. INTRODUCTION

The demand of electrical power energy has grown exponentially in recent times and to meet this demand electrical power system network needs more sophistication and consequently more complexity. Transmission lines are mostly located in the open and therefore, environmental effects can result in fault occurrences. When fault is appears in the transmission line, the users should inform the authorities and they have to disconnect the power immediately. The power transmission is occurred due to natural disasters or manmade mistakes and other many conditions those outcomes may causes a human being. These unexpected happening may affect the ordinary person and other living things. Fault detection is essential to the safe operation of electric power transmission and distribution system The ability to detect and diagnose the faults can help greatly in the protection of transmission line. This project presents modern solution of fault detection and power quality analysis of overhead transmission lines by implanting Wavelet Transform (WT). When fault is appears in the transmission line, the users should inform the authorities and they have to disconnect the power immediately. The power transmission is occurred due to natural disasters or manmade mistakes and other many conditions those outcomes may causes a human beings. The wavelet transform method for fault location is an accurate method to detect the faults in transmission line. MATLAB software is used to simulate different operating and fault conditions on high voltage transmission line, namely single phase to ground fault, line to line fault, double line to ground. By analyzing the waveform we can calculate which fault occurring in the line.

II. WAVELET TRANSFORM

It is linear transformation like Fourier transform, with one difference that it allows time localization of different frequency component of given signal. Short time Fourier transforms achieve partially same thing but with a limitation of using a fixed width windowing function. In case of wavelet transform, the analysing functions, which are called wavelets, will adjust their time width to their frequency in such a way that, higher frequency wavelet will be very narrow and lower frequency wavelet will be broader. This property of multi resolution is particularly useful for analysing fault transients which contains localized high frequency component superposed on power frequency signals. Thus wavelet transform is better suited for analysis of signal containing short lived high frequency disturbance. superposed on lower frequency continuous waveforms by virtue of this zoom in capability. Given function $x(t)$, its continuous wavelet transform will be calculated as follows:

$$WT(a, b) = \frac{1}{\sqrt{a}} \int_{-\infty}^{\infty} x(t) \psi \left(\frac{t-b}{a} \right) dt$$



A. Decomposition of Faulty Signal

WT is a tool which analyses the faulty signals obtained from the transmission line in the time as well as frequency domains effectively. It provides a non – uniform division of frequency domain which uses short window at high frequency and long window at low frequency. Using the multi resolution analysis (MRA) algorithm, a particular band of frequencies present in the fault signal can be analysed. Transient voltages and currents signals during the fault carry high frequency components which carry important information regarding detection, classification and location of faults on the transmission line. MRA is a WT algorithm which decomposes the original fault signals to low frequency fault signal called approximations and high frequency fault signal called details. The approximations are denoted by the letter A1 to An and details denoted by the letter D1 to Dn. Where n = 1, 2, 3 ...k.

Let A0 (n) be the discrete time voltage or current fault signal from transmission line station or generated from the transmission line Simulink block model. These fault signals are to be decomposed into the detail and approximation. From the MRA algorithm, the decomposed fault signals at scale 1 are A1 (n) and D1 (n). where A1 (n) is the version of the original fault signal (Approximation) and D1(n) fault signal (detail) detailed representation of the original fault signal A0 (n) inform of wavelet transform coefficient.

$$A_1(n) = \sum_k h(k - 2n) A_0(k) \quad D_1(n) = \sum_k g(k - 2n) A_0(k)$$

Where h(n) and g(n) are the associated filter coefficient that decomposes A0(n) into A1(n) and D1 (n) respectively. This means in the first stage decomposition, the original fault signal is divided it two Halves of the frequency band. The next higher scale decomposition is now based on the fault signal A1(n). The decomposed fault signal at scale two is given by;

$$A_2(n) = \sum_k h(k - 2n) A_1(k) \quad D_2(n) = \sum_k g(k - 2n) A_1(k)$$

B. Selection of Mother Wavelet

The selection of mother wavelet is an important issue for decomposition of faults and PQ disturbances as the proper selection of mother wavelet results in accurate detection of disturbances. Successful application of wavelet transform depends heavily on the mother wavelet. To choose a suitable mother wavelet, the properties of the wavelet function must be considered carefully. Generally, the objective of the wavelet analysis and the characteristic of the analyzed object decide the mother wavelet. If a signal has a few isolated singularities and is very regular between the singularities, a wavelet with many vanishing moments can be chosen to produce mainly small coefficients. If there are many singularities, it would be better to decrease the support size at the cost of lower number of vanishing moments. Wavelet analysis that overlaps the singularities of a signal would create high coefficients. Furthermore, if signal reconstruction is needed, a more regular wavelet is preferred in order to obtain a smoother reconstructed signal. There are several mother wavelets such as Daubechies, Morlet, Haar, Symlet etc.

C. Daubechies wavelet

The Daubechies families of wavelets are the most widely used. The Daubechies wavelet has several orders such as Db2, Db3, Db4, Db5, Db6, Db7, Db8, and Db10etc.The Daubechies wavelets with 4, 6, 8, and10 filter coefficients work well in most disturbance cases This is perhaps due to its wavelets satisfying the necessary properties as described in the previous paragraph. Daubechies wavelets are also well known and widely used in other applications. It is flexible as its order can be controlled to suit specific requirements.

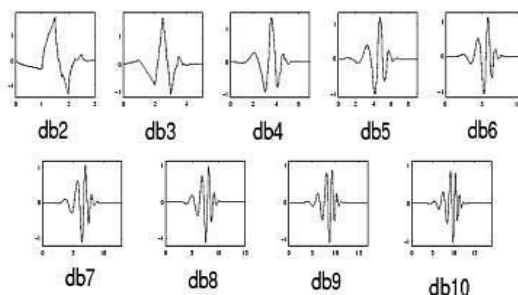

Figure 1. Daubechies wavelet

III. TRANSMISSION LINE FAULTS AND POWER QUALITY DISTURBANCE

To spread power from generating stations to remote load centers, transmission lines are used. Due to lightning, mis-operation, overload, short circuits, human errors, faulty equipment and aging, faults may occur on these lines. When fault occurs, the faulted phase voltage decreases and huge currents will flow which can burn out the components if not interrupted quickly. In transmission lines with a three-phase power source, there are ten types of faults that can occur. The faults in the order of decreasing frequency of occurrence: single-phase-to-ground faults (L-G), phase-to-phase faults (L-L), double-phase-to ground faults (L-L-G), and a three-phase fault (3- ϕ). Single line to ground faults occurs when one of the phases is shortened to the ground. Electric Power Quality (PQ) is a very important issue as far the power supply utilization is concerned. It is the measure of electric power supply quality reached to the customer end for their specific utilization.

IV. SIMULINK MODEL OF TRANSMISSION LINE SYSTEM

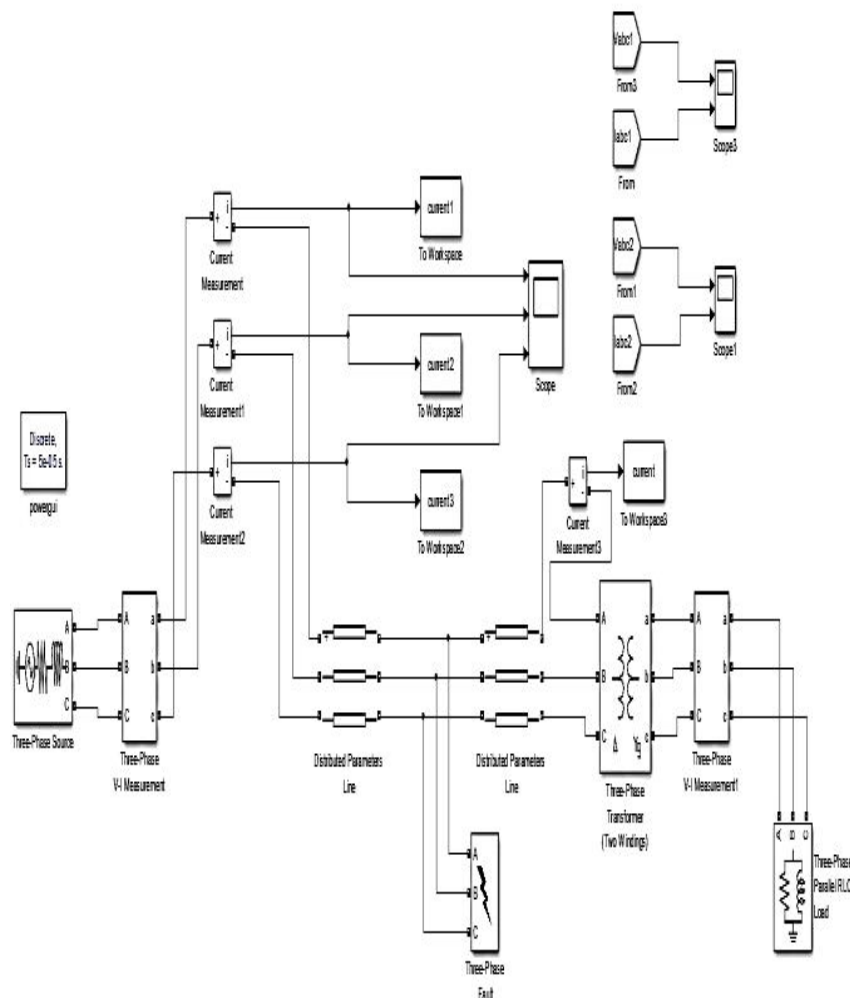

Figure 2. Simulink model

The system is simulated using MATLAB/ Simulink software. Let us consider a faulted transmission line in electrical power system as shown in figure. A 11KV transmission line system has been simulated to detection and simulation. The faulted on transmission line is represented by distributed parameters. As an application of 50 Km transmission line with the parameter of the transmission line simulation diagram shown in figure 2.



Organized by

Royal College of Engineering and Technology, Thrissur, Kerala, India

V. SIMULATION RESULTS

a. *Without Fault*

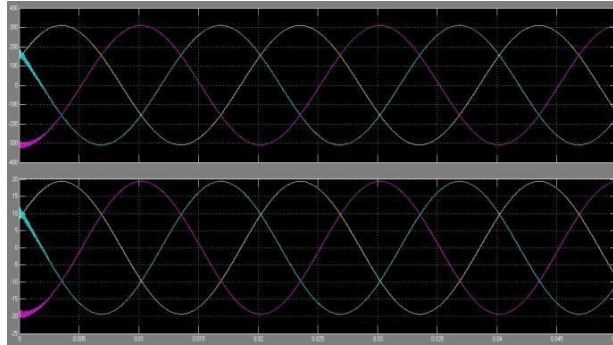

b. *Single Line To Ground Fault*

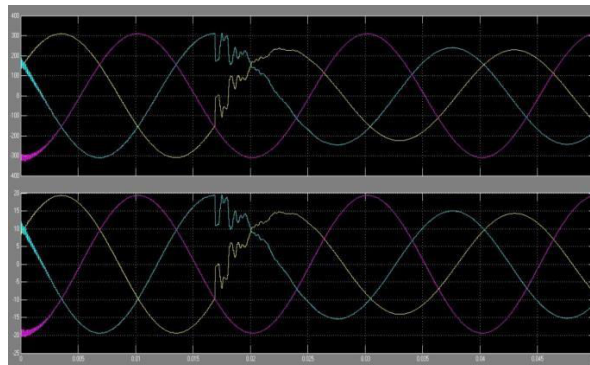

c. *Line To Line Fault*

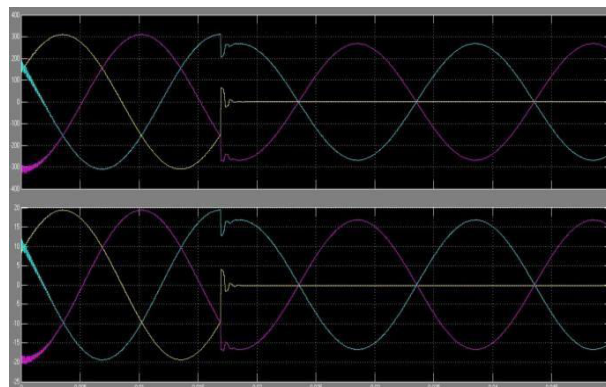



National Conference on Emerging Technologies [NCET' 2021]

Organized by

Royal College of Engineering and Technology, Thrissur, Kerala, India

d. Double Line To Ground Fault

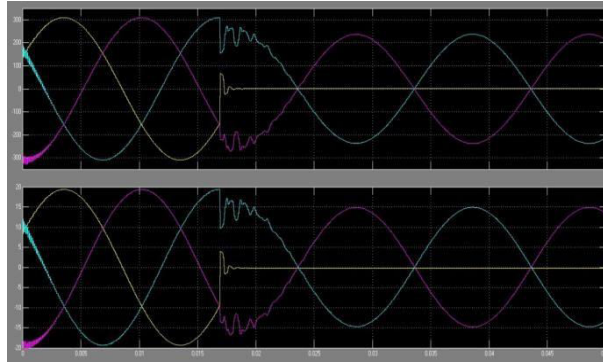

e. Three Phase Fault

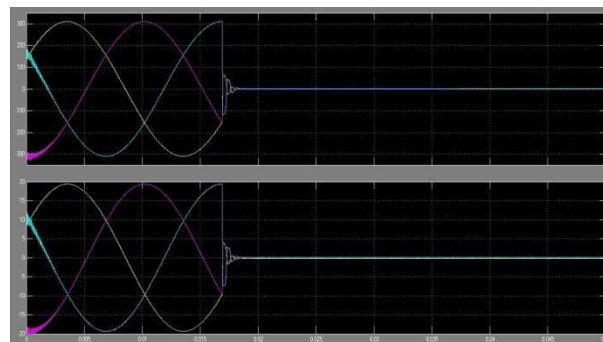

Analyze the faulty signal using wavelet toolbox. Then the signals are decomposed until level 5 with Daubechies wavelet 3. Among those level observed that level5 gives best views to accuracy of Daubechies wavelet. For analyzing faulty signals the following steps are done in Matlab.

d. Coefficient Details

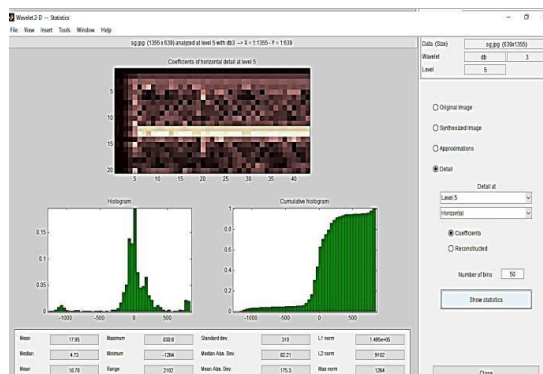



National Conference on Emerging Technologies [NCET' 2021]

Organized by

Royal College of Engineering and Technology, Thrissur, Kerala, India

e. Compressed Signal

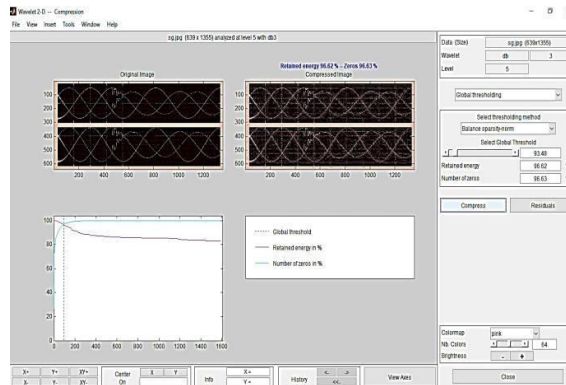

VI. CONCLUSION

This paper explains a technique to protect the overhead transmission line from faults and power quality disturbance. Faults which occur on transmission lines not only effect the equipment but also the power quality. The paper presents a new wavelet transform based technique to detect the different faults and power quality disturbance in transmission lines for quick and reliable operation of protection. The ability of wavelets to decompose the signal into frequency bands in both time and frequency allows accurate fault detection and transmission line are simulated in MATLAB software to detection the faults. Wavelet based transmission line fault identification is deterministic in nature and easy to implement.

REFERENCES

1. V. C. Ogboh , E. A. Ezeakudo, E. C. Nwangugu-*Wavelet Transform Technique for Fault Detection on Power System Transmission Line* , © SEP 2019 | IRE Journals | Volume 3 Issue 3 | ISSN: 2456-8880
2. Manohar Mishra, -*Power quality disturbance detection and classification using signal processing and soft computing techniques: A comprehensive review* | Int Trans Electr Energ Syst. 2019;29:e1, 2008.
3. Chengzong P., Mladenk, Zhang N., *Wavelet Based Method for Transmission Line Fault Detection and Classification During Power Swing*, Texas A & M University College Station, TX77843, USA, WERC 323, MS 3128
4. B. Ravindranath and Dr. M. Vijaya Kumar, -*Fault detection, classification and location on transmission lines using wavelet transform*, | IEEE Annual Report Conference on Electrical Insulation and Dielectric Phenomena, 2009.
5. R.Malkar, V. Magdum and S.Gunda, *Transmission line fault analysis using wavelet theory*”, International journal of Engineering science and Tech, vol.4, No.6, June 2012..



**Impact Factor:
7.569**



INTERNATIONAL JOURNAL OF INNOVATIVE RESEARCH

IN SCIENCE | ENGINEERING | TECHNOLOGY

 9940 572 462  6381 907 438  ijirset@gmail.com



www.ijirset.com

Scan to save the contact details