



e-ISSN: 2319-8753 | p-ISSN: 2347-6710

# IJIRSET

International Journal of Innovative Research in  
**SCIENCE | ENGINEERING | TECHNOLOGY**

# INTERNATIONAL JOURNAL OF INNOVATIVE RESEARCH

IN SCIENCE | ENGINEERING | TECHNOLOGY

Volume 11, Issue 1, January 2022

**ISSN** INTERNATIONAL  
STANDARD  
SERIAL  
NUMBER  
INDIA

Impact Factor: 7.569

9940 572 462

6381 907 438

[ijirset@gmail.com](mailto:ijirset@gmail.com)

[www.ijirset.com](http://www.ijirset.com)



# Hybrid Prosthetic Arm: An Approach towards Synergizing Body Powered Mechanism and Electronics to Develop A Cost-Effective Prosthetic Arm

Himanshu Yadav<sup>1\*</sup>, Shikhar Srivastava<sup>2</sup>, Dr.Maneesh C Srivastava<sup>3</sup>, Mr.Ashwani Sharma<sup>4</sup>

UG Scholar, Department of Mechanical Engineering, Amity School of Engineering and Technology,  
Uttar Pradesh, India<sup>1</sup>

UG Scholar, Department of Mechanical Engineering, Amity School of Engineering and Technology,  
Uttar Pradesh, India<sup>2</sup>

Head of Department, Department of Mechanical Engineering, Amity School of Engineering and Technology,  
Uttar Pradesh, India<sup>3</sup>

Assistant Professor, Department of Mechanical Engineering, Amity School of Engineering and Technology,  
Uttar Pradesh, India<sup>4</sup>

**ABSTRACT:** People suffer emotional and social trauma whenever they lose their body parts because of any mishap, especially if it is an essential functional limb like hand whose loss affects their daily work. Prostheses are tools that aid people with amputations to facilitate certain physical functions which were lost due to trauma. Prosthetic arms are a generally employed medical equipment that are used by the person suffering from arm amputations or specially abled people. There are various challenges which are related with the manufacturing of a low-cost prosthetic arm. At the same time, the prosthetic arms present in the market have certain drawbacks in terms of functionality, design, ease of use and cost-effectiveness. With the progress in computer aided 3D designing and 3D printing the design and manufacturing of complex hand design and related accessories has become straight forward and cost effective. The project aims at helping people with arm amputations, by developing a low cost and user-friendly prosthetic design. The proposed prosthetic hand is a hybrid design which will make use of a simple string tension mechanism to generate effective grip and extension of hand.

**KEYWORDS:** Prostheses, prosthetic arm, 3D-printing, additive manufacturing, tension mechanism

## I. INTRODUCTION

The paper aims at the design, modification and fabrication of a prosthetic hand for specially abled people or person with arm amputations. Once an individual becomes an amputee, they have to bear the emotional, social, financial traumas. In addition they have to cope with difficult lifestyle changes. When a person gets amputated by any portion of the arm, it affects their functional abilities such as holding, grasping, catching, reaching, sense of touch and communication. People with any kind of amputation may develop a negative self-image about themselves because of reduction in their abilities. Prosthetics can become boon for such persons as it can assist them to restore certain functional abilities up to a particular extent and would make their daily tasks easy. Prosthetic is an artificial extension that acts as replacement for the amputated body part. An artificial limb is any form of prosthesis that acts as replacement for the body parts at limbs, like the arms (upper limb prosthetics) and legs (lower limb prosthetics).

An open-source body powered hand design available on E-Nable, is used for development of hybrid mechanism by connecting the various components. The focus is mainly on the below elbow amputation since the number of patients is relatively more, for this kind of amputation.

The focal point of the project is to create an affordable prosthetic hand that is easy to operate, easy to maintain, has long-life, cost-effective production and be able to restore the functionalities of the missing human hand. The proposed hand concept will not only cater to the requirements of the amputee, as well as be aesthetically pleasing.



**1.1 Need**

Every year a large number of people get amputated due to accidents, man-made or natural disasters. Current reports highlights that there are 1-2 amputees per 1000 people in the world population.

We are entering into the era of the end of human disability where artificial intelligence, advanced electronics and mechanical designs have collectively made it feasible for amputees to get natural capabilities.

But when it comes to affordability a large part of this population remains untouched. So, the present scenario demands a user friendly, affordable and capable prosthesis design.

In countries like India not all needy people can afford prosthetic parts, so a good design capable of handling daily basic needs can be a boon for them.

Among the 6.7 billion world population, 3 million people suffer from arm amputation. In India alone there are 0.5 million arm amputees and around 23500 added per year. As per the report of ‘World Health Organization’ published in 2009 says by 2030 road accidents will be the fifth highest cause of death. The estimated rate of road fatalities per 100000 is 22.6 as per global status report on road safety by WHO (2018). So considering huge population, India will be among leading countries with large number of amputee.

**II. LITERATURE REVIEW**

A prosthetic hand can be considered as an artificial tool/ body part that can be used to bring back the basic functionalities of the lost body parts. The loss of an arm or any portion of it may occur due to disease, accident, war injury, could be by birth or in any surgical procedure. The prosthetic hand can be an effective tool for any person with arm amputations.

Prosthetics are being used by humans since ancient times. The earliest evidence of prosthetics comes from ancient Egypt dated back to between 950 BCE to 710 BCE, which includes a passive prosthetic for human toe amputation. At present time prosthetics are available for almost every body part such as eyes, ears, joints of knee, shoulder and hip, nose, legs, fingers and hands.

The project basically focuses hand especially for below elbow amputations. Thus, the literature survey and project mainly focus on development of hand prosthetics. During the research we found that there are different types of prosthetic arms available in the market, and their average cost ranges from 150-200 thousand rupees. Cosmetic (aesthetic) prosthetic hands which are static in nature cost between 5,000-10,000 thousand rupees. The cost of ‘hero arm’ by open bionic starts from 3,000 USD. Even the cheapest functional arm cost around 50,000 rupees.

During the project research it has been observed that 40,000 people lose their upper arm and more than 16,500 lose below elbow arm every year. As per the research there are almost 3 million arm amputees in the world, [Table-1] shows number of people with different types of arm amputations.

**Table 1. Number of People with Different Types of Arm Amputations**

Type of Arm Amputation	Number of People (approx.) in millions
Below elbow	1.4
Above elbow/ elbow disarticulated	0.7
Shoulder	0.2
Hand/ Wrist	0.1

The annual average earning of a person in India is about 1,26,000 rupees, in such scenario only very few people can afford to buy such expensive prosthetic arms. Prosthetics arm are of following type depending upon their functional nature: -



- Cosmetic/ Static
- Body-Powered
- Myoelectric
- Hybrid
- Neural Controlled

Prosthetics on the basis of their application on body portion can be categorized as-

- **Joint Prosthetics**- Used when joints of elbow, knees, shoulder, hip etc. get damaged.
- **Arm Prosthetics**: - Employed to replace the lost portion or whole of the arm.
- **Leg Prosthetics**: - Employed for replacement of part of leg or whole leg.
- **Cosmetic prosthetics**; - They are passive in nature and do not have any dynamic performance, utilized mainly for aesthetic purposes like artificial eyes, ears, nose, breasts, moulded fingers and toes.

Some of the leading prosthetic manufacturers are mentioned below: -

- Ottobock- Duderstadt, Germany
- Endolite- United Kingdom
- ALIMCO - Artificial Limbs Manufacturing Corporation of India- Kanpur, India
- Ace Prosthetics- Columbus, Ohio, United States
- Open Bionic- International bionic arm provider community- Bristol United Kingdom
- Human technology - Prosthetics and Orthotics- San Francisco, California, United States
- Arm Dynamics- California, United States

### III. LIMITATIONS OF PRESENT PROSTHESES

- **Affordability**:-Expensive sensors and actuators increase the cost of the design as not every person can afford such large expenses. Every year a lot of people in the world lose their body parts but they can't have prosthesis because of cost problems. The initial cost of prosthesis is high (mostly in lakhs), but it's not a one-time investment because due to wear and tear it needs to be updated and improvised with time which adds up to surplus cost.
- **Heavy**:-Even several very fine prosthetic arms are double in weight in comparison to True Limb. A survey updated on 'Sage Journal' suggests that 45% of amputees are refusing to use electronic prosthesis and these rates are even high in the young generation which is around 81%. The main problem comes out of this survey is weight. The weight is not a major problem for the normal human body until it is not attached to one person for a long duration but in case of prosthesis it becomes a major issue as it needs to be fixed at the end of the limb.
- **Inefficient**:-The use of prosthetic arms becomes a challenge in daily life due to lack of understanding of usability and improper sensory feedback. Improper fitting of prosthetic socket contributes to uneven distribution of load over limbs which makes design inefficient. The designs which are available in the market are not efficient enough, they are only completing the body parts but not fulfilling the actual requirement of prosthesis. Most of the time the failure of a component occurs due to load or technical issues which can cause other problems. Sometimes amputees feel difficulty in doing some difficult tasks in fear of damaging prosthetic parts or attached body parts. Poor suspension and uncomfortable fitting can cause some major problems in the body like blocking blood circulation in the limb. Sometimes it may cause clotting and rashes on the fitting limb end. If the size of the prosthetic arm will not be equal in size it will cause problems to amputee in extending and shortening hands while picking and placing. It will also create asymmetry in doing daily work.

### IV. BODY POWERED DEVICES

Body powered prosthetic devices move relative to the user's body movement. In this mechanism, body harness attached with tensioning cords are attached to the portion of the body that is fit and functions normally. By this hand grips, elbow and wrist moments can easily be generated and controlled.

Advantages of body powered prosthesis are: -

- They can be used in any kind of environment wet, dry or dusty.
- Simple in operation, it can be voluntarily open or closed by the user.



- It is durable and reliable
- It has low noise and almost silent operation during action.
- Comparatively light in weight.

Some common body powered prosthetics are mentioned below: -

- Voluntarily opening split hook- It is a mechanism which is very popular. It is a popular body powered device. It is reliable and effective. Hosner is a company that makes such hand devices.
- System Hand- This mechanism is made by Ottobock. It has an aesthetic look. It comprises three major components- inner hand chassis comprising the mechanism, the inner hand having shape as that of a human hand and a cosmetic glove. They are of generally two types voluntarily opened or voluntarily closed.

## V. MATERIALS AND TOOLS REQUIRED

The development of the project requires a lot of different materials (resources), tools both hardware and software. The hand would be manufactured by using additive manufacturing hence an FDM 3D printer was required. The design is hybrid in nature hence electronic components like sensors, batteries, resistors, jump wires, electrical switches and microcontroller are used. In addition servo motors and geared motors were used for actuation. The sensors used include the flex sensor and capacitive touch sensors. Since the tension mechanism is used for opening and closing the hand grip, nylons string and elastic strings were used. For 3D printing the filament material used was PLA. The 3D printer used was Creality Ender 3 V2. The software tools used includes CAD software like Solidworks and space claim, the slicer software used for 3D printing is Ultimaker Cura. The microcontroller used was Arduino NANO and the Arduino IDE software was used for programming.

### 5.1 Resourcerequirement (Hardware & software etc.): -

- **Hardware Resources-**
  - Servo Motors
  - Arduino NANO board
  - Sensors- Flex Sensor and Touch Sensor
  - 3D Printer
  - PLA Filament Bundle
  - Battery
  - Nylon Strings and Elastic Strings
  - Tools- Screw Driver, Pliers, Cutter, Soldering kit
  - Jump wires
  - Resistors and bread board
  - Straps
  - Velcro
- **Software Resources-**
  - Arduino IDE
  - UltimakerCura 4.0
  - Solidworks
  - Ansys

## VI. E-NABLE GROUP

E-Nable is a fast-growing online community consisting of more than 3600 members including teachers, engineers, scientists, medical professionals and designers. collaborating to make free prosthetics using 3D printing. The E-Nable has some open-source prosthetic designs that can be accessed and modified by anyone. The community builds these designs and manufactures them for any person in need. The designs available are low cost and body powered hand design. The initial design of hand does not need any kind of actuator like a motor or solenoid, hence no requirement of any kind of sensor or EMG. This makes the hand cost effective, light in weight and easy to use.

Some of the E-Nable designs are mentioned below: -

- **K-1-** [Fig-1] The most common hand design, it employs string - tension mechanism for actuation of grip and elastic to open the hand grip.<http://enablingthefuture.org/k-1-hand/>

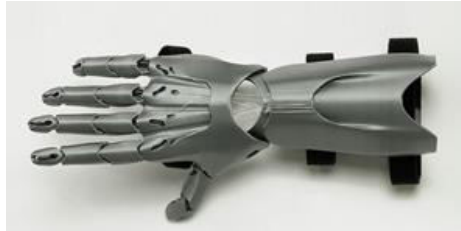

Fig 1. K-1

- **Raptor Reloaded:** - [Fig-2] The design has similar mechanism as K1, but its finger and palm are more curved to make effective grip. It has better ergonomics.  
<http://enablingthefuture.org/upper-limb-prosthetics/raptor-reloaded/>



Fig 2. Raptor Reloaded

- **RIT Arm:** - [Fig-3] This kind of design is for trans radial patients. It uses the whipltree mechanism for producing adaptive grip.  
<http://enablingthefuture.org/upper-limb-prosthetics/rit-arm/>



Fig 3. RIT Arm

- **Flexy hand:** - [Fig-4] This design is more aesthetic in nature, with natural finger looks. It uses the pin tensioning mechanism and flexible joints for closing and opening hand grip respectively. <https://www.thingiverse.com/thing:380665>



Fig 4. Flexy Hand

- **Cyborg Beast:** - [Fig-5] This is a popular hand design which uses the same string mechanism and elastic mechanism but it is not aesthetically pleasing. <https://www.thingiverse.com/thing:261462>
- 



Fig 5. Cyborg Beast

## VII. MICROCONTROLLER

- It is the brain of the board which controls and operates overall activities over the board. It updates, uploads and executes uploaded code and commands based on the user inserted code.
- **Arduino Nano:** [Fig-6] This is the most compact member of the Arduino microcontroller family that can be employed when users have to use less modules and have less space to fit in.



Fig 6. Arduino NANO Board

### 7.1 On the Board

**USB input:** It is used to program and power the board.

**DC Input:** For powering the board from an external source.

**3.3 V pins and 5 V pins:** These are used to power the external modules, sensors and motors etc.

**GND Pins:** These pins are used to ground or give zero voltage to the circuit board.

**Analog Pins:** They allow analog signals to convert into digital one which can be read by the software.

**Digital Pins:** They allow reading digital signals from hardware modules.

**Reset Button:** It is used to restart or re-upload the program on the board.

**RX/ TX pins:** They are generally utilized when data is transmitted from, and received into the board.

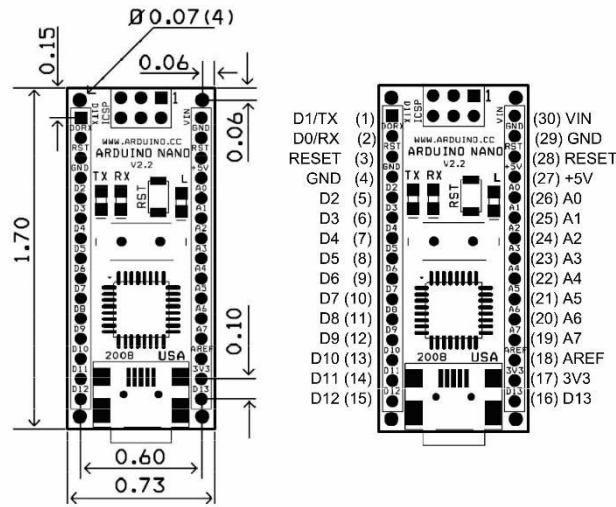

Fig 7. Arduino NANO Pin Diagram

### VIII. SENSORS

These are different kinds of sensor available for receiving and sensing the data and information from the surrounding in the form of temperature, pressure, resistance, moisture, light etc. with the help of sensors like pressure sensor, light sensor, UV sensor, temperature sensor, moisture sensor, flex sensor etc.

#### 8.1 Flex Sensor

The flex sensor [Fig-8], referred to as bend sensor is a transducer element which is used as a sensor to measure bend caused by a bending force. In it the resistance of the element varies as per the bending applied to it. The working principle and construction of bend sensors is similar to that of strain gauge sensors. It consists of a strain gauge element which could be a metal wire, strip or a semiconductor material. When it is subjected to strain (i.e. ratio of change in length to original length) due to bending force, its resistance changes with change in length, the original resistance being referred to as 'flat resistance' denoted by  $R$ . [Table-2] shows specifications of sensor. The ratio of change in resistance to original resistance is proportional to the strain. This change in resistance is measured and the corresponding bend is calculated by the microprocessor.

$$\Delta L/L = \epsilon$$

$$\Delta R/R \propto \epsilon$$

$$\Delta R/R = G\epsilon$$

$G$  is the constant of proportionality and is called the gauge factor.



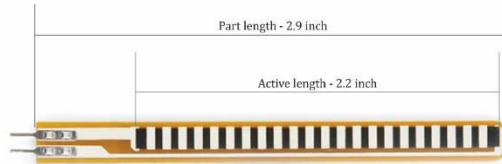

**Fig 9. Flex Sensor**

**Table 2. Flex Sensor Specification**

Length	56mm
Operating Voltage	0-5 volt
Power Rating	0.5 W (continuous), 1 W (peak)
Flat Resistance	25K $\Omega$
Resistance Tolerance	30%
Bend Resistance Range	45K $\Omega$ -125K $\Omega$

### 8.2 Experimental Analysis of Flex Sensor

The experiment involves bending of touch sensor from rest position to various bend angles, the analog sensor values obtained by Arduino were read via serial monitor. [Fig-9] shows circuit diagram of flex sensor. Two readings were taken for bending of flex sensor and corresponding analog signal, which are shown in [Table-3]. The output voltage and increased resistance values were calculated based on the following equations [Eq-1] and [Eq-2] respectively. The analog signal values, resistance and voltage output were then plotted against various bending angles, [Fig-10], [Fig-11] and [Fig-12].

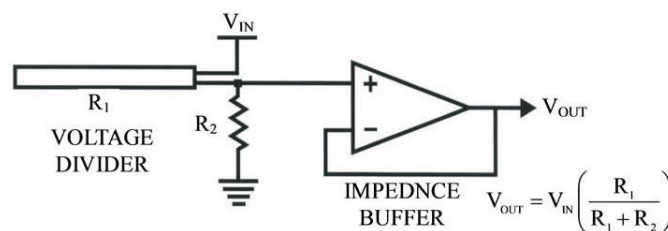

**Fig 9. Circuit Diagram of Flex Sensor**

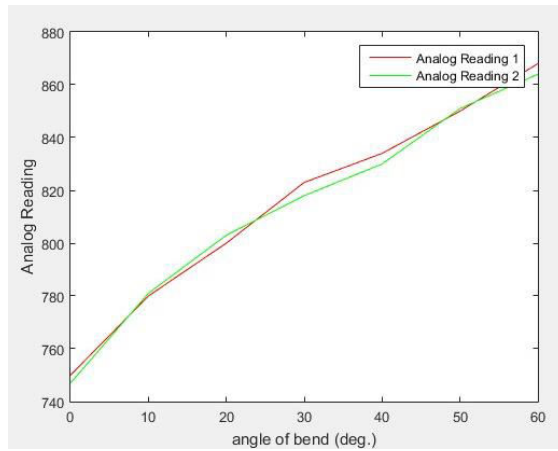

Fig 10. Analog Reading vs Angle of Bend

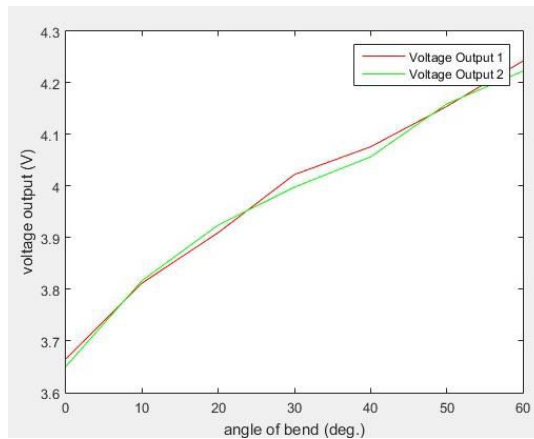

Fig 11. Voltage Output vs Angle of Bend

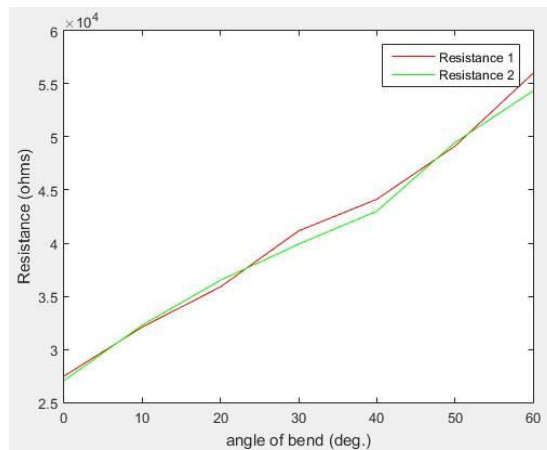

Fig 12. Resistance vs Angle of Bend



**Table 3. Analog Signal reading observation**

Sr. No	Bend Angle (Degree)	Analog Signal Reading 1	Analog Signal Reading 2
1	0	750	747
2	10	780	781
3	20	800	803
4	30	823	818
5	40	834	830
6	50	850	851
7	60	868	864

$$R_1 = \frac{R_2}{\frac{V_{in}}{V_{out}} - 1} \tag{1}$$

$$\text{Voltage Reading} = \text{Analog Signal Reading} * \frac{V_{in}}{1023} \tag{2}$$

**8.3 Touch Sensor**

The touch sensor [Fig-13], has a capacitive element transducer, it consists of two capacitive plates along with dielectric material between, as the displacement between the plates changes the related capacitance also varies. The touch sensor used in the project is a capacitive type proximity sensor, in it there is only one capacitor plate formed by an embedded electrode on the sensor with the object behaving as the second capacitor plate. When the object reaches closer to the sensor, the plate separation varies, this variation (change in distance between the plates) causes change in capacitance which is sensed by the sensor. [Table-4] shows specification of sensor. On detecting this change the single channel latching switch is activated.

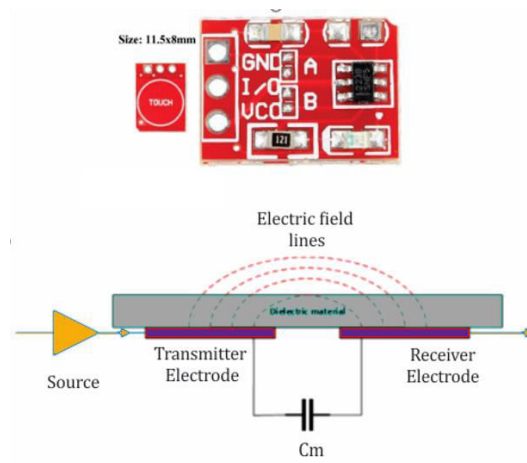

**Fig 13. Touch Sensor**



Model	TTP223
Input Voltage	2 V -5.5 V
Response Time	60 mS - 220 mS (based on power mode)
Capacitance	0 -50 pF
Sensor Range	5 mm
Recalibration Period	4 seconds

Table 4. Touch Sensor

IX. MOTORS

The motors used in the project are servo motors. Two light servo motors for controlling movements of thumb and index finger, and high torque motor for controlling motion of hand grip. The light servo motor is Micro Servo SG90 [Fig-14] and high torque motor is MG995 [Fig-15]. digital high- speed servo.

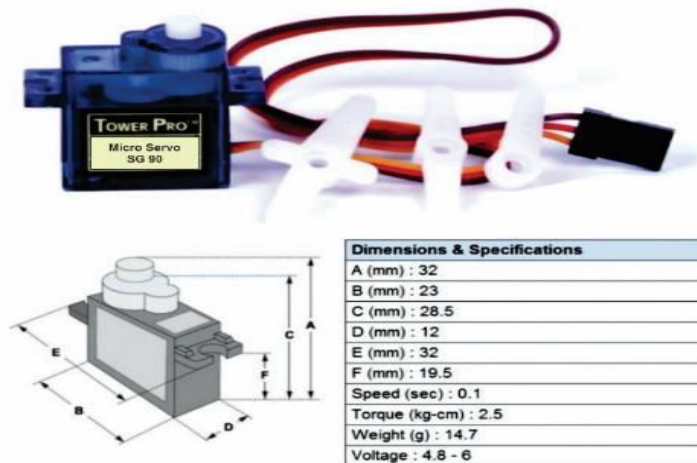

Fig 14. Servo Motor SG90

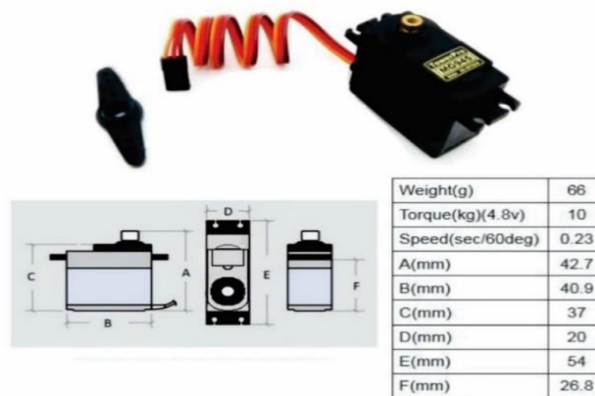
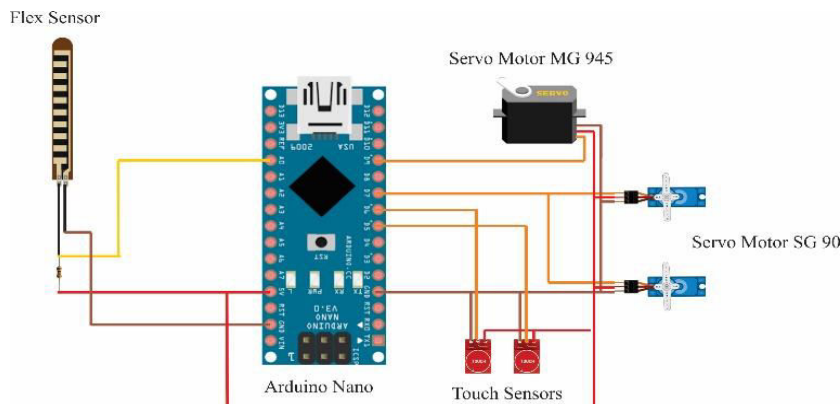

Fig 15. Servo Motor MG945

**X. CIRCUIT DIAGRAM**

- As circuit [Fig-16] show there is a Flex sensor, Servo Motor MG945 (for high torque; in four fingers and thumb) and a pair of touch sensor.
- Servo Motor SG 90(for low torque; in thumb and index finger separately).
- Except for flex sensor all other components constitute three different wires representing 5V current (red), ground(brown), and input (orange).
- Flex sensor has two outgoing wires in which one is ground(brown) and other connects with.



**Fig 16. Circuit Diagram for various components**

**XI. METHOD OF MANUFACTURING**

For the creation of the prosthetic hand the major components would be produced by additive manufacturing. [Fig-17 and Fig-18] shows printing process Additive Manufacturing: - AM is an unconventional, and bottom to top approach of manufacturing. It is called 3D printing as in this process 2D layers of material which correspond to the cross section of the model are stacked in 3D space. In AM a computer-controlled mechanism is used to create a 3D object directly from 3D CAD model by depositing layer on horizontal plane and stacking this layer in vertical plane till object is made. The manufacturing method used is 'Fused Filament Fabrication' and 3 D printer used Creality Ender 3 V2, and the material used is PLA filament (diameter =1.75 mm), its properties are mentioned in the [Table 5].

**Table 5. Specification of PLA Material**

Property	Value
Technical Name	Polylactic Acid (PLA)
Chemical Formula	(C <sub>3</sub> H <sub>4</sub> O <sub>2</sub> ) <sub>n</sub>
Melt Temperature	157-170 °C
Tensile Strength	61- 66 MPa
Flexural Strength	48-110 MPa
Shrink Rate	0.37- 0.41%

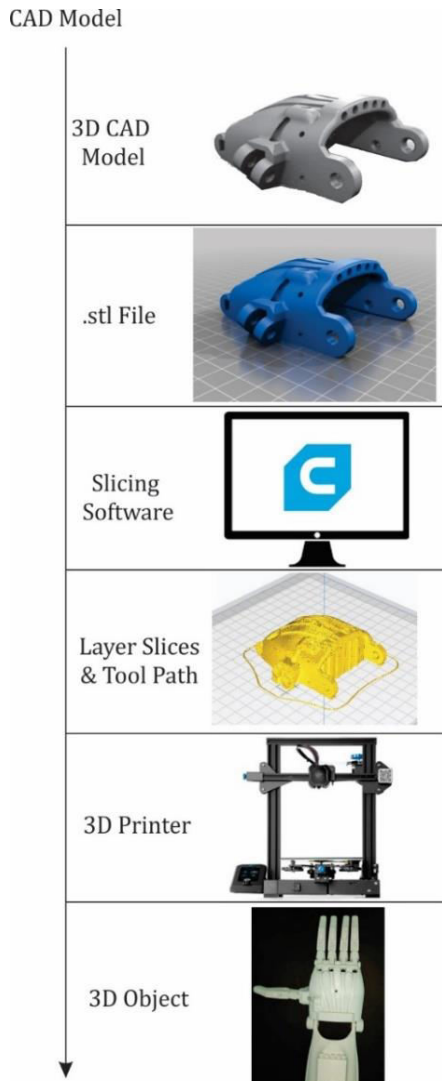

Fig 17. 3D Printing

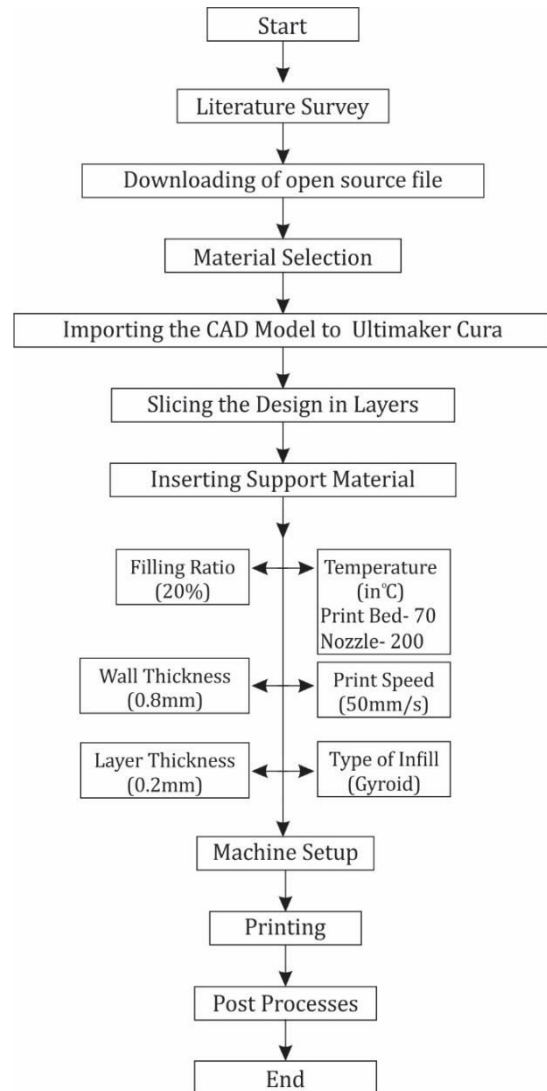

Fig 18. Steps in Additive Manufacturing using Fused Filament Fabrication

**XII. DESIGN OVERVIEW AND ASSEMBLY PARTS**

1. 31 different 3D printed pieces assembled together to form the resultant raptor hand. [Fig- 19] shows exploded part view of raptor design and [Fig-20] shows assembled 3D printed prosthetic hand
2. There are three different sized fingertips in which 3 of them are medium sized out of which two are index finger and ring finger, and third one for the thumb. In the remaining two fingers design the longest one is treated as the middle finger and the smallest one as little or pinky finger. Each fingertip has two small hole ways one at the top portion and other at bottom portion. The lower portion of the fingertip is tightened up with the non-extensible string and upper portion is tightened with extensible string at the distal phalanx part of the finger. The extensible string then comes out through the whole way toward the palm section.
3. There are five different proximal phalanges which connect the palm and fingertips together where fingertips and proximal phalanges are connected using five finger snap pins. Two pieces of knuckle pins are used to connect palm and proximal phalanges. At the knuckle position of the palm section small holes have been made for proper positioning of the extensible string coming from the upper portion of the fingertip. Further these strings follow some engraved path printed over the top section of the palm design. Again at the end of this palm section again five different holes have

been made at this point the upper strings are tightened up to the desired limit then a knot is made once the end location of the fingers is reached to the desired limit.

4. Further palm and gauntlet are connected via two different hinge pins using hinge caps.

7. Minor design changes were done to the 'Raptor Design' to incorporate necessary functionality, two 5mm diameter holes were made, one at center of the palm and other at side of palm, opposite the thumb side, so as to allow easy and smooth connection of cords with motor shaft.

8. Tensioner pins, retention clip and tensioner block were excluded from final design as they were not required.

5. The non-extensible strings coming out from the lower part of the fingertips through the hole of the upper palm present at the back-end part connected with single main string.

6. A set of plastic tubes were attached at the inner face of the palm, parallel to fingers so that strings pass easily and have smooth movement while working without causing any interruption [Fig-21] and [Fig-22].

9. A body harness [Fig-23] was also made using webbed nylon straps and a side release buckle was attached to the center of harness.

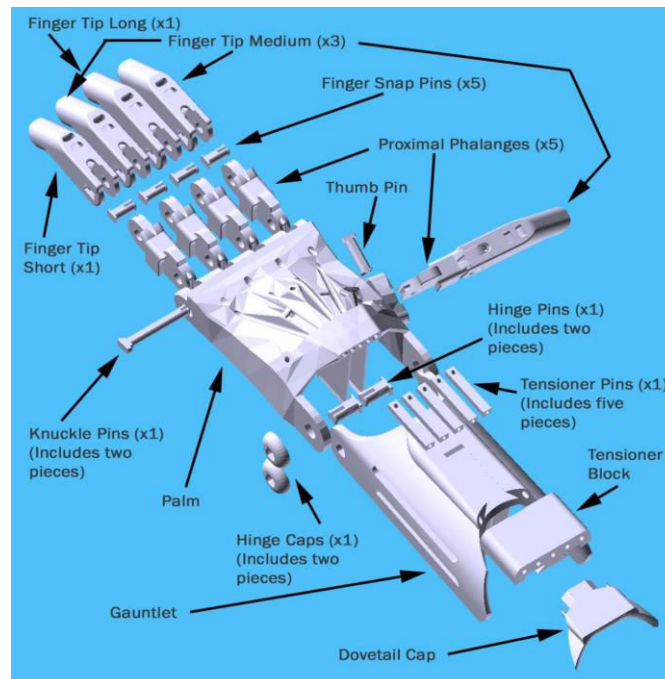

Figure 19. Exploded view of Raptor Design



Figure 20. 3D Printed Prosthetic Hand

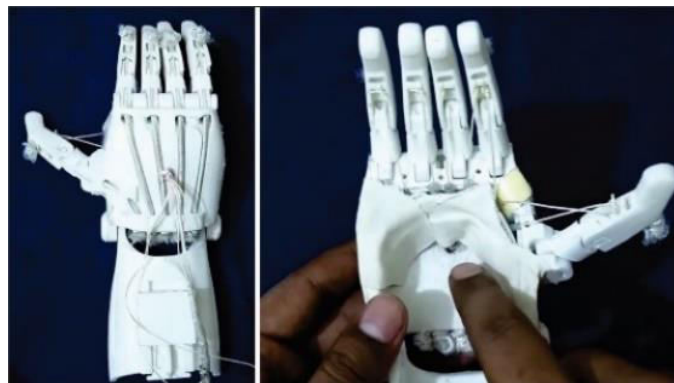
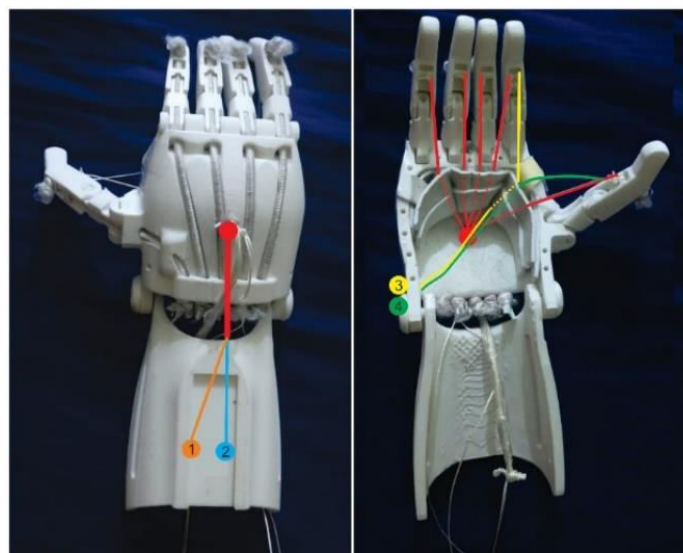

Figure 21. Front and back



1 Connected to MG995 Servo Motor for mechatronical mode  
2 Connected to Harness for Body powered mode  
3

Figure 22. String attachments and their route





**Front View**



**Back View**

**Figure 23. Front and Back View of Harness**

### XIII. WORKING

There are two different mode of working of the design which can work independently depending upon the user's choice.

- **Mechanical Design:** This is the case which is purely mechanical and uses body power to create tension in the string for closing the hand.
- **Mechatronics Design:** In this case different sensors and like flex and touch are used which are powered by some battery and depending upon these values three different servo motors controls thumb, index finger and all other four fingers independently.

#### 13.1 Mechanical Mode

- 3D printed raptor design remains open due to stretchable string (elastic cords). When non stretchable string (nylon cord strings) tied at lower end of the palm and fingertip are pulled the finger closes the palm. This is the simple gripping mechanism. To create tension in the string body power is used, to do so a string made of nylon is tied with the tensioner block through tensioner pins.
- This tensioner block is finally tied with another string which follow up arm through small band present below and above elbow reaches back of the body.
- The string takes a sharp turn near armpit from band present above elbow to the region near scapula. This kind of attachment gives extra shortness to the string which in return gives additional tension to the string by application of little movement of the arm or in simple words increases the sensitivity of the mechanism.
- Further the string is connected with the slot present in between scapula or in aligned with spine.
- The slot is attached to vest like design which made light and soft cloth so that amputee doesn't feel any discomfort. It creates symmetry along the body from middle so that the user doesn't feel any disbalance which is again another reason for placing the slot near the spine. It is possible that the amputee feels a little odd in the beginning but with the time due to its perfect location it will become habitual.

- The vest design used is does not fully cover the upper body part but it is designed like straps which crosses over at the back and wore like bag which looks like strap from the front to back end. The cross position of the strap is utilized as a slot.
- Now as mentioned in the beginning the palm remains open at initials when amputee brings their hand forward the tension comes begins to act on the strings which pulls the fingers inward direction that grabs the object present in between the fingers and the palm.
- The amputee can use this man powered mechanism arm to hold heavy objects as well.
- Now an important point to mention here is that the user needs to keep his arm little forward to keep holding his object.
- The mechanical design fulfils basic holding, grabbing and dropping [Fig-24] show different positions.



**Five Fingers Grip**



**Two finger Pinch**

**Figure 24. Gripping and Pinching connection**

### 13.2 Mechatronic Mode

- The second mode is mechatronics mode in this all the sensors, motors and microcontrollers are fired up with battery power. This mode is designed for more precise and desirable working of hand. In this case the amputee will be able to use his thumb and index finger to pick and use small objects like spoon, brush, pencil etc.
- To perform so two touch sensors [Fig-25] are mounted over the different locations naming side position of the distal phalanges of the finger and Dorsal position of the palm. Along with this one flex sensor [Fig-25] is used at back side of elbow. Both sensors works independently and one at a time[Fig-26].
- Three different size servo motors [Fig-25] have been used in the hand; the larger and powerful servo for closing four fingers for perfect and strong grip. The remaining two servo are used for bringing index finger and thumb together.
- For running these components, a light weighted battery is placed at socket present at the back portion of the hand from which, proper wiring is done to power the electronic components.
- A microcontroller- Arduino Nano is used to control different electronic components.
- To open and close the five fingers a flex sensor is used which works on the principle of bending which in further synchronised with the servo motor i.e., if more bending will occur the stronger grip will be generated as servo motor will turn more which will produce additional tension in the non-extensible string. The flex

sensor is placed at the elbow portion of the arm [Fig-27], with the bending of elbow flex sensor would bend this in result would move the servo motor.

- To pick and hold spoon or any light object capacitive touch sensor is used which get activated whenever any object comes in touch with the small capacitors present over the surface of the touch sensor. This activates the servo motors present on the palm portion which brings index finger closer to the thumb and thumb to the index from slightly above position simultaneously. Due to this the object present between the finger and thumb get gripped.
- For releasing the picked object there is another touch sensor present at the bottom part of the side (Dorsal) is used. To release the object the second touch sensor is touched to the surface where the object needed to be placed this will activate the servo motor in opposite direction which in result will release the object.

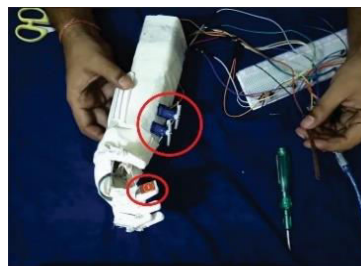

**Position of Touch Sensor 1 and SG 90 Servo motor**

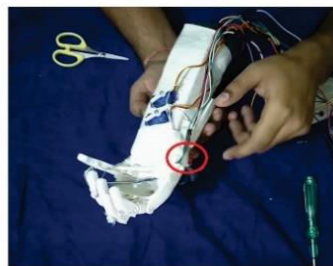

**Position of Touch Sensor 2**

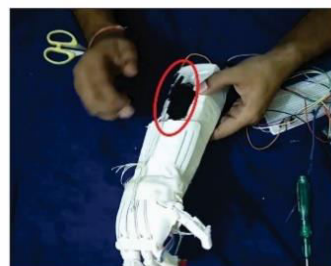

**Position of MG 995 motor**

**Figure 25. Positioning of sensors and servo motors**



**Working of Flex Sensor**



**Working of Touch Sensor**

**Figure 26. Working of sensors**

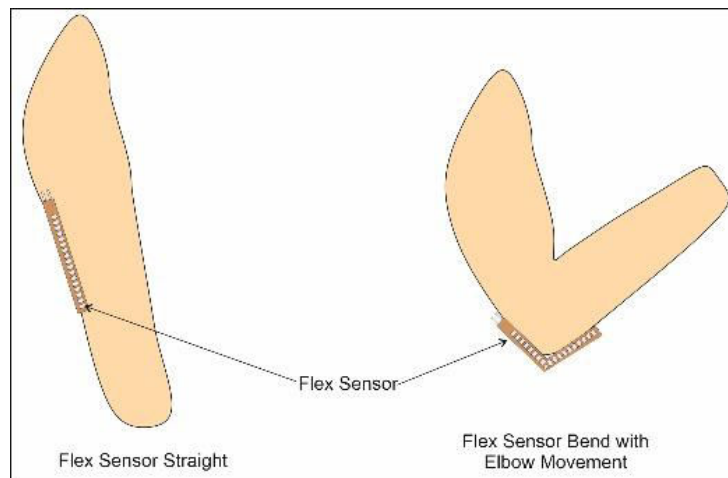

**Figure 27. Position of flex sensor at the elbow and its movement**

#### XIV. RESULT

The following hand has been created and tested considering real world scenarios. The design can successfully execute different kind of basic and desirable motions like picking, placing, grabbing, dropping, holding etc [Fig- 28]. The prosthetic hand has passed most of the designed constraints and worked very well within range of its parameters mentioned and created in the problem statement. Overall, the design is friendly, easy to use, cost effective and most importantly able to perform daily basic tasks.



**Figure 28. Movement of Prosthetic hand**

## XV. CONCLUSIONS

A small 3D printed hybrid hand mechanism was successfully designed, analyzed and tested. Special consideration was given to the fact that the device should be cost effective, light in weight and easy to use. The advanced and quick 3D printing technology assists the project in a very beneficial manner, to achieve the objectives of our project. The main hand design was based on the 'Raptor Reloaded version 2' hand design model provided by the e-Nable community. Its effectiveness was improved significantly by attaching a body harness, sensors, microprocessor and forearm-elbow extension to provide users with easy functionality. During our work we developed the forearm elbow extension in manner that it is light in weight but has sufficient strength to carry heavy loads. A latex cover was given to fingers to ensure effective gripping friction.

## REFERENCES

- [1] Sullivan, Mark; Oh, Bryan; and Taylor, Ian, "3d Printed Prosthetic Hand" (2017).
- [2] Sachin Makvana."Design & Experimental Analysis of Human Hand Prosthetic."(2016)
- [3] TusharShushil Kulkarni; RashmiUddanwaadikar; ",Overview: Mechanism and Control of a Prosthetic Arm"(2016)
- [4] AndrySayuk."Design and implementation of a low cost hand for prosthetic applications"(2015)
- [5] Ian Gibson; David Rosen; and Brent Stucker."Additive Manufacturing Technologies-3D Printing, Rapid prototyping, and Direct Digital Manufacturing". Springer.
- [6] Ms.HumeraTabassum Dept. of Electronics and Instrumentation P.D.A College of Engineering Kalaburagi Karnataka India; Prof.VeenaSaraf Assistant Professor, Dept. of E&C P.D.A College of Engineering Kalaburagi Karnataka India. A Low Cost Prosthetic Hand using Arduino and Servo Motors
- [7] Pascal Weiner\*, Julia Starke\*, Felix Hundhausen, Jonas Beil and TamimAsfour.The KIT Prosthetic Hand: Design and Control
- [8] Paul Ventimiglia (LA&E) Washington Polytechnic Institute Design of a Human Hand Prosthesis (2012)
- [9] Salvatore Brischetto and Roberto Torre Department of Mechanical and Aerospace Engineering, Politecnico di Torino, CorsoDucadegli Abruzzi 24, 10129 Torino, Italy; roberto.torre@polito.it.Tensile and Compressive Behavior in the Experimental Tests for PLA Specimens Produced via Fused Deposition Modelling Technique.
- [10] R.G.E. Clement\*, K.E. Bugler, C.W. Oliver Department of Trauma and Orthopaedics, Royal Infirmary of Edinburgh, 51 Little France Crescent, Old Dalkeith Road, Edinburgh EH16 4SA, UK. Bionic prosthetic hands: A review of present technology and future aspirations.



- [11] Myer Kutz. BIOMEDICAL ENGINEERING AND DESIGN HANDBOOK Volume 1: Fundamentals. McGraw Hill.
- [12] Todd Letcher; Megan Waytashek. MATERIAL PROPERTY TESTING OF 3D-PRINTED SPECIMEN IN PLA ON AN ENTRY-LEVEL 3D PRINTER.
- [13] JacekSzkopek \* and GrzegorzRedlarski Faculty of Electrical and Control Engineering, Gdansk University of Technology, 80-233 Gdansk, Poland; [grzegorz.redlarski@pg.edu.pl](mailto:grzegorz.redlarski@pg.edu.pl). Artificial-Hand Technology—Current State of Knowledge in Designing and Forecasting Changes.
- [14] Richard F. ff. Weir, Ph.D., Northwestern University Prosthetics Research Laboratory, and Rehabilitation Engineering Research Center, Chicago, Illinois. DESIGN OF ARTIFICIAL ARMS AND HANDS FOR PROSTHETIC APPLICATIONS. Chapter 32; STANDARD HANDBOOK OF BIOMEDICAL ENGINEERING AND DESIGN.
- [15] William Bolton; “Mechatronics Electronic control Systems in Mechanical and Electrical Engineering” sixth edition. Pearson
- [16] <https://www.businesswire.com/news/home/20170601006465/en/Top-5-Vendors-in-the-Orthopedic-Prosthetics-Market-from-2017-to-2021-Technavio>
- [17] <http://enablingthefuture.org/upper-limb-prosthetics/raptor-reloaded/>
- [18] <https://mcoopro.com/blog/resources/arm-hand-prosthetics/>
- [19] <https://3dinsider.com/what-is-pla/>
- [20] <https://www.creativemechanisms.com/blog/learn-about-polylactic-acid-pla-prototypes>
- [21] <https://ultimaker.com/about-ultimaker>
- [22] [http://www.svnirtar.nic.in/sites/default/files/resourcebook/1\\_Amputation-Dr\\_N\\_K\\_Behera.pdf](http://www.svnirtar.nic.in/sites/default/files/resourcebook/1_Amputation-Dr_N_K_Behera.pdf)
- [23] [http://www.limbless-association.org/images/Types\\_of\\_Amputation.pdf](http://www.limbless-association.org/images/Types_of_Amputation.pdf)
- [24] Wikipedia- The free Encyclopaedia; [www.wikipedia.com](http://www.wikipedia.com)
- [25] Google Images- Image Search Engine; <https://www.google.com/imghp?hl=EN>
- [26] Global Road Safety Report-<https://www.who.int/publications/i/item/9789241565684>
- [27] [https://cdn.website.thryv.com/328c55b24a4f4f05b88e578f4e58a16d/files/uploaded/Types\\_of\\_Amputation.pdf](https://cdn.website.thryv.com/328c55b24a4f4f05b88e578f4e58a16d/files/uploaded/Types_of_Amputation.pdf)
- [28] Raptor Reloaded- <http://enablingthefuture.org/upper-limb-prosthetics/raptor-reloaded/>. Download-  
<https://www.thingiverse.com/thing:596966>



**Impact Factor:  
7.569**



# INTERNATIONAL JOURNAL OF INNOVATIVE RESEARCH

IN SCIENCE | ENGINEERING | TECHNOLOGY

 9940 572 462  6381 907 438  [ijirset@gmail.com](mailto:ijirset@gmail.com)



[www.ijirset.com](http://www.ijirset.com)

Scan to save the contact details