



e-ISSN: 2319-8753 | p-ISSN: 2347-6710

IJIRSET

International Journal of Innovative Research in
SCIENCE | ENGINEERING | TECHNOLOGY

INTERNATIONAL JOURNAL OF INNOVATIVE RESEARCH

IN SCIENCE | ENGINEERING | TECHNOLOGY

Volume 12, Issue 8, August 2023

ISSN INTERNATIONAL
STANDARD
SERIAL
NUMBER
INDIA

Impact Factor: 8.423

9940 572 462

6381 907 438

ijirset@gmail.com

www.ijirset.com

Reducing Energy Storage Utilization in a Stand-Alone DC Microgrid through Photovoltaic Power Management

Abdul Qavi Bahashwan¹, Sanjay M.Shinde²

M.Tech EPS Student, Government College of Engineering, Aurangabad (MS), India

Associate Professor, Department of Electrical Engineering, Government College of Engineering, Aurangabad (MS), India

ABSTRACT- Direct-current microgrids (dcMG) facilitates the integration of renewable energy sources as a form of distributed generators (DGs), DC loads, and energy storage system devices. Direct-current microgrids (dcMG) have gained worldwide attention in recent decades due to their high system efficiency and simple control. In a self-sufficient/independent energy system, voltage control is an important key to dealing with upcoming challenges of renewable energy integration into DC microgrids (dcMG), and thus energy storage systems and photovoltaic (PV) panel are often employed to suppress the power fluctuation and ensure the voltage stability. Battery energy storage systems (BESSs) & PV panel are used to provide energy to users in cases of power failure or major energy quality problems, and the test results of different load configurations of microgrids at the time of interruption were given. The charging controller control the connection in case of power failure. A centralized approach is presented to achieve accurate power-sharing and satisfactory DC bus voltage control.

KEYWORDS- Direct Current, Energy Storage, Microgrid, PV power, ATmega8, Solar, state-of-charge

I. INTRODUCTION

Over the last few decades, due to the increased global population and industrialization, the energy demand has been increased manifold. As a result, huge energy generation from fossil fuels has created several environmental problems. In order to mitigate the environmental issues and meet increased energy demand, renewable energy (RE) has gained more attention. However, several technical issues, such as uncertainty, complex control, less reliability, low inertia, fault ride through capability, and reserve capacity have arisen due to RE integration [1], [2]. The DC microgrid has great capability to facilitate RE integration in the form of the distributed generator (DG). The DC microgrid offers several benefits in DG integration compared to AC microgrid such as solar photovoltaic (PV) connection to the DC bus without any inverter, direct connection of DC loads to the DC bus, and no reactive power and frequency control issues. A centralized approach is presented to achieve accurate power-sharing and satisfactory DC bus voltage control. However, such a communication-based centralized hierarchical control approach has less reliability as it is susceptible to the single point failure. Therefore, the reliability of the DC microgrid can be improved with the sparse communication-based distributed control algorithms. The power-sharing and voltage regulation can be achieved by voltage regulation terms, processed by the proportional-integral (PI) controllers, which are added to the conventional droop controller. Nevertheless, these control approaches face large-signal stability problems.

Microgrids can combine distribution networks, renewable energy power supply systems, energy storage systems, local loads, etc., and represent important parts of the energy Internet. The existing microgrid project mainly uses an alternating-current (AC) microgrid, which is compatible with the AC power grid and AC power equipment. However, the output of photovoltaic power generation, fuel cells and other renewable energy sources is DC. In order to adjust the output frequency,

wind power generation, gas turbine and other renewable energy sources usually convert AC output into DC for further use [1]. The output of many energy storage batteries, such as batteries and lithium batteries in energy storage devices, is also DC. At the same time, DC electrical equipment such as electronic equipment, electric vehicles, LED lighting equipment are increasingly widely used. Therefore, the above DC source load storage is directly connected to the DC converter through the DC bus to form a DC microgrid, which can effectively reduce the cost and power loss of intermediate conversion linking, and improve the power supply quality [2]. Compared with AC microgrids, DC microgrids have many advantages, such as high efficiency, high reliability, high controllability, low cost, etc. It is an ideal scheme for the further development of microgrid.

Compared with AC microgrids, DC microgrids have no problems in reactive power, phase and frequency, and DC voltage has become an important indicator of system stability [3]. In DC microgrid system, in order to ensure the stability of DC voltage, it is necessary to coordinate the control of multiple microsources. Reference [4] proposed a voltage-layered coordination control strategy. The control strategy coordinates the working mode of power electronic converters by detecting the variation in DC voltage and maintains the stability of DC voltage. However, under the same working conditions, only one inverter in the system uses the droop characteristic to participate in voltage regulation. Due to the limitation of the inverter's own capacity, the voltage regulation capability of the system is low. In order to improve the overall voltage regulation capability of the system, multiple inverters are required to participate in voltage regulation at the same time. Reference [5] proposed an improved droop control method based on the residual capacity of an energy storage unit. The droop coefficient is set according to the residual capacity of the energy storage unit to realize the coordinated control of DC voltage between distributed energy storage units. Due to the diversity of the main voltage-regulating units in the microgrid, it is necessary to adjust the DC voltage with multiple different main voltage-regulating units and at the same time to improve the overall voltage-regulating capability of the system. Each main voltage-regulating unit can maintain the power balance of the system according to its droop characteristics by setting different droop coefficients, so as to achieve the purpose of coordinated control of DC voltage at the same time. Reference [6] analyzed the stability of DC microgrids after droop control through eigenvalue loci and used impedance matching criteria to increase active damping through low-pass filtering to suppress voltage oscillation. Reference [7] considered power filtering, droop characteristics and other factors, and analyzed the influence of constant power load and droop coefficient on system stability through linearization. References [8,9] established a small-signal model based on the characteristic curve of constant power load, and obtained the conditions that the system needs to meet to achieve stable operation by analyzing the voltage transfer function of load and power side. A multi-source coordinated control strategy based on voltage slopes is proposed in reference [10]. This strategy includes using the voltage-stabilizing control strategy of section I at the moment of voltage drop at the grid side, the voltage-stabilizing control strategy of section II after the energy storage is out of operation and the corresponding secondary control. The strategy proposed in this paper can effectively accelerate the bus stability time and reduce its fluctuation, but the selection of energy storage unit is still based on the battery energy storage. Reference [11] proposed the use of three evolutionary search algorithms, particle swarm optimization (PSO), simulated annealing (SA) and genetic algorithms (GA), to determine the optimal parameter values of the fractional-order (FO)-PI controllers implemented in dual-active bridge-based (DAB) DC microgrids. The aim of this was to find the optimal parameters for these controllers in terms of voltage stability. Reference [12] proposed a passivity-based nonlinear control for an isolated microgrid system. The microgrid consists of a photovoltaic array and battery energy storage connected to a point of common converters, supplying a constant power load. The purpose of this control strategy is to maintain the output direct current voltage in its reference value under load variations, improving battery interaction. Reference [13] proposes a DC-side synchronous active power control for two-stage photovoltaic power generation without energy storage, which can keep the DC link voltage stable under the condition of changing light intensity.

Distributed energy is booming, and these distributed power generation units are widely integrated into microgrids. Renewable energy is usually highly dependent on weather conditions, resulting in a certain degree of intermittence and uncertainty, which brings pressure to the operation and control of microgrids. Reference [14] realized extremely low-

frequency energy harvesting by utilizing an escapement mechanism to achieve frequency tuning. Reference [6] proposed an optimal planning method considering wind power and photovoltaic power limiting measures to optimize the optimal planning of DG integration location and optimal capacity, and to formulate consumption plans for each period.

Renewable energy generally exists in the microgrid, and energy storage is usually required to decouple fluctuating energy supply and rigid energy demand, improve the flexibility of the system, and ensure the reliable operation of the system. As an indispensable part of the microgrid, the energy storage system is of great significance for improving the power quality, stability and operating efficiency of the microgrid, as well as achieving peak shaving and valley filling. However, under the current technical conditions, stability and operating efficiency of the microgrid, as well as achieving peak shaving and valley filling. However, under the current technical conditions, single-energy storage methods, such as existing batteries, supercapacitors, flywheel energy storage, superconducting energy storage, etc., which are suitable for microgrid applications, cannot simultaneously take into account the needs of energy density, power density and energy storage time. As a result, composite energy storage technology has come into being.

The structure of this paper is as follows: the details of the proposed control strategy is introduced in Section I, literature survey is done in Section II, Methodology in Section III, Discussion in Section IV and the conclusions of the paper are stated in Section V.

II. LITERATURE SURVEY

Reference [1] considered the battery degradation and thermal runaway propagation, established a multi-state model of BESS, and studied the reliability of large-scale grid-connected BESS and its impact on the overall reliability of power system. Reference [2] proposed a power distribution method of a composite energy storage system based on the state of charge by combining battery and super capacitor. Reference [3] used second-order filtering to separate wind power, and distributed high-frequency power to supercapacitors and intermediate-frequency components to batteries for stabilization. However, this method had phase lag characteristics when extracting grid connected power, which increased energy storage output.

Reference [4] used a wavelet transform to decompose wind power, and determined the boundary frequency of energy type and power type compensation. Low-frequency power components are taken as grid connected power, while medium-frequency and high-frequency power components are compensated by energy type and power type energy storage. On this basis, reference [5] conducts power allocation based on empirical mode decomposition, and allocates energy type and power type energy storage compensation power based on minimum mode aliasing. However, the above research only studied the combination of energy storage and power storage.

References [6] discussed the role of compressed air energy storage (CAES) system in coordinated dispatching, phase modulation and other auxiliary services. Reference [7] studied the unit commitment of power systems with a CAES power station and wind power grid connection, and made specific analysis from many aspects such as wind power consumption, congestion management, peak shaving and valley filling. References [8] and [9], respectively, put forward a capacity optimization configuration method for isolated microgrids with a CAES power station and wind power generation system with an AA-CAES power station. With the goal of minimizing the sum of system operation cost and environmental cost, as well as the sum of user interruptible load cost and system comprehensive cost, the optimal configuration capacity of a CAES/AA-CAES power station, a wind turbine generator unit and other units was obtained.

Reference [10] addressed the development of the energy compensation method used for the design a hybrid energy storage system (HBESS). The study examined the energy density that each chemical element carries in its structure, as well as the electrochemical cell that can be composed of one or more elements. The specific energy difference between two battery technologies makes it possible to determine which compensation factor should be adopted for each technology. This



method was developed to meet the demand for substations outside the Brazilian standard of power systems, which lack an uninterrupted and reliable energy source. The method was validated by designing a microgrid to support the auxiliary systems of a transmission substation in northeastern Brazil. The operation and control strategy of energy storage systems, intended for application in hybrid microgrids with AC coupling, was proposed in reference [11].

In reference [12], battery energy storage systems (BESSs) were used to provide energy to users in cases of power failure or major energy quality problems, and the test results of different load configurations of microgrids at the time of interruption were given. The functionality of the BESS was evaluated in the face of real outages that occurred in a microgrid located in the Brazilian countryside. The results presented demonstrated the effectiveness of BESS in the energy supply of microgrid loads.

Reference [13] studied the power quality issues related to wind turbines and power systems, as well as how (BESS) can solve or mitigate these disturbances in the network. The research into wind farms provided the results of five applications (factor correction, voltage control, power factor smoothing, frequency control and time shift). A BESS was paralleled with a wind turbine. The effectiveness of the BESS was verified by the actual operation data of each application.

III. METHODOLOGY

A. ATmega 8

ATmega8 is a popular microcontroller chip from the Atmel AVR family, commonly used for various control and automation applications. When combined with an H-Bridge inverter, it can be used for solar-fed DC motor control while keeping a battery as a secondary source. The main feature of Atmega8 Microcontroller is that all the pins of the Microcontroller support two signals except 5-pins. The Atmega8 microcontroller consists of 28 pins where pins 9,10,14,15,16,17,18,19 are used for port B, Pins 23,24,25,26,27,28 and 1 are used for port C and pins 2,3,4,5,6,11,12 are used for port D.

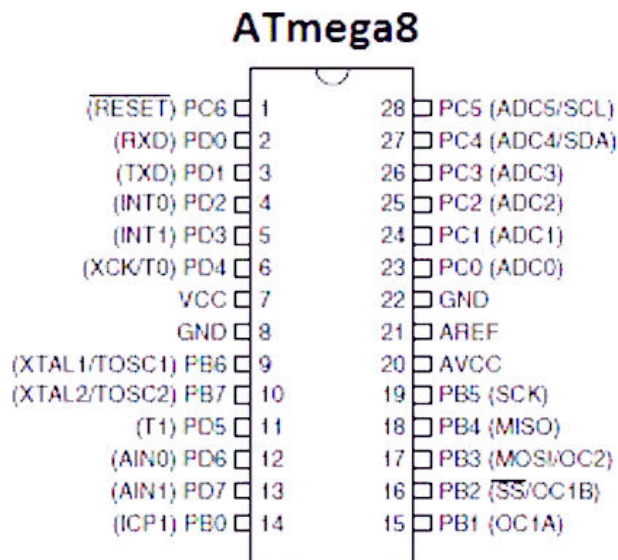

Figure 1- ATmega 8 Controller

B. DC Microgrid System Structure

Figure 2 shows the structural diagram of the DC microgrid system and battery energy storage. The diesel generator and AA-CAES system are connected to the DC bus of the microgrid through an AC/DC converter, and the battery is connected

to the DC bus through a DC/DC converter. The DC microgrid in this paper adopts a single-bus structure, and all power generation units, energy storage units and loads are connected to the same DC bus. Under this configuration, the location and placement of the ESS may have little influence on its ability to participate in grid operations, and so the optimum location and placement of the ESS has not been considered. In the figure, P_G , P_C , P_{PV} and P_B are the output power of the diesel generator set, AA-CAES, photovoltaic power generation unit and battery, respectively.

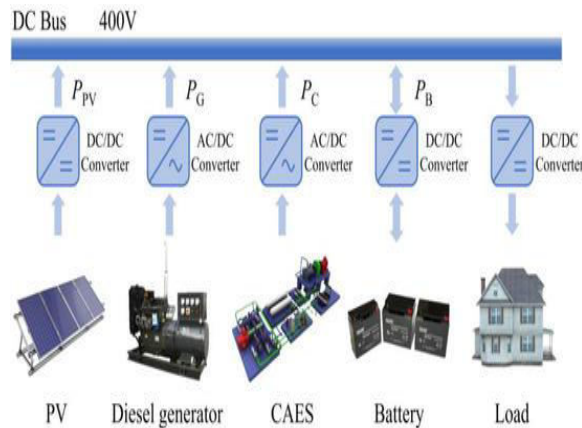

Figure 2- DC microgrid system structure

C. Modeling of Photovoltaic Power Generation Unit

The equivalent circuits of the solar photovoltaic system and DC/DC boost converter are shown in Figure 3. In the figure, V_{PV} is the output voltage of the solar photovoltaic unit, I_{PV} is the output current of the solar photovoltaic unit, C_{pv} is the filter capacitor, L_{pv} is the inductance, R_{pv} is the internal resistance, I_L is the inductance current, C_{dc} is the DC bus capacitance, V_{dc} is the DC bus voltage, I_{dc} is the output current of the converter, and μ is the duty cycle of the converter MOSFET switch.

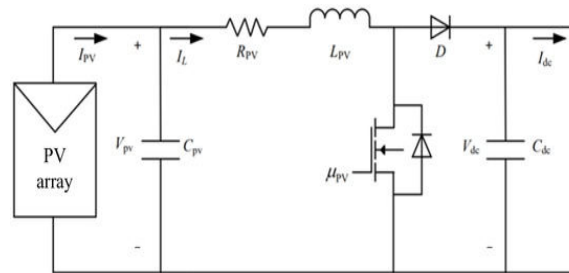

Figure 3- circuit diagram of solar PV system and DC/DC boost converter

IV. DISCUSSION

The proposed system is implemented using hardware. The circuit diagram which is implementation is shown in figure 4. The implementation is done with Solar Panel (PV cells) and Battery. The charging controller control the connection in case of power failure. If the power supply failure is occurs, the controller decides the connection either to battery unit or to PV array. We prefer the controller is ATmega8 in our hardware implementation. The battery used by us in experimentation is Car's Battery which is of 35 Ah. This case study exhibits that the proposed control strategy prolongs the Li-ion battery aging, based on different battery degrading parameters, by 29.93 % as compared to the conventional control strategy. The proposed control techniques did not consider reducing the battery utilization and the excessive use of battery power to regulate the dc-link voltage is a drawback that drastically shortens the battery lifetime. Furthermore, the proposed control

proposed limits the state-of-charge (SoC) to an estimated SoC reference, which is predicted based on the load demand patterns, to prolong the battery lifetime. However, the control involves with the online communication platform for the forecasting data and it is only effective in the grid-connected system since it limits the battery charging capacity. In the conventional control strategy, the PV operates with the Controller and the BESS operates continuously to effectively regulate the dc-link voltage V_{dc} by intaking all the power fluctuations from the load and the PV output. When the battery SoC reaches to $SoC_{max} = 100\%$, the PV system is disconnected from the circuit to prevent any overcharging issue, and only the battery is in operation. The battery restores energy with the PV surplus generation since the battery SoC is below SoC_{th} (95% in this case). When the battery SoC reaches to $SoC_{max} = 100\%$, as illustrated in Fig. 11(b), the battery converter is turned off in the proposed control strategy and only the PV supplies the load demand. Hence, the temperature of the battery decreases back to the room temperature. The battery only operates again when the PV power is insufficient for the load demand or the SoC drops below SoC_{th} .

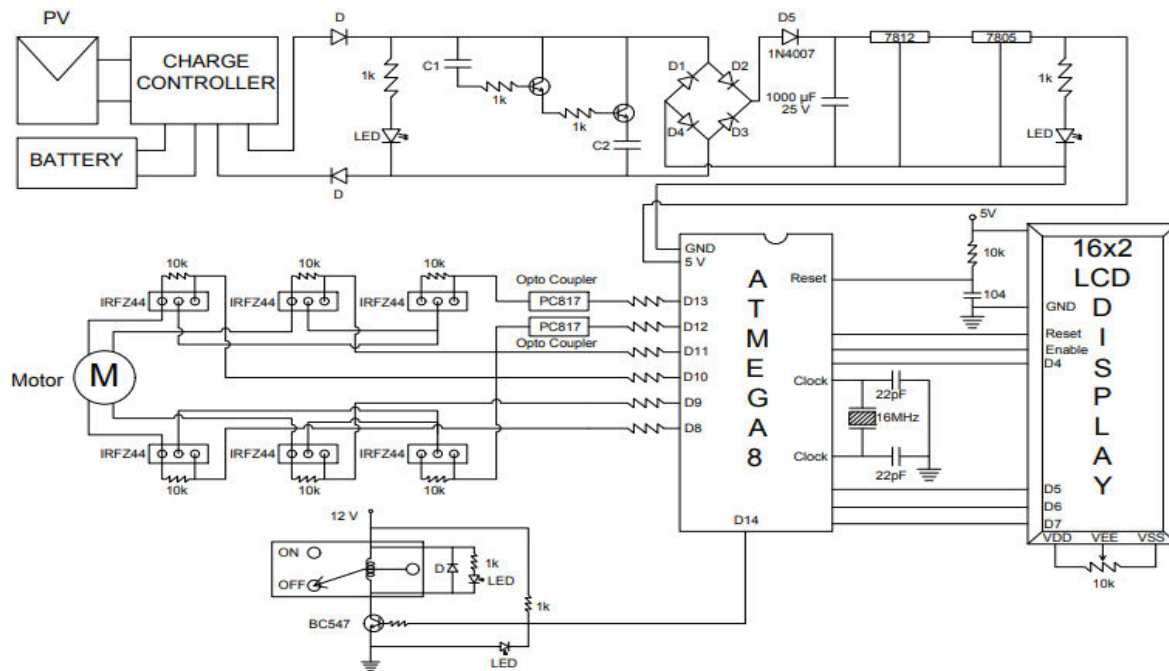

Figure 4- Implementation of system

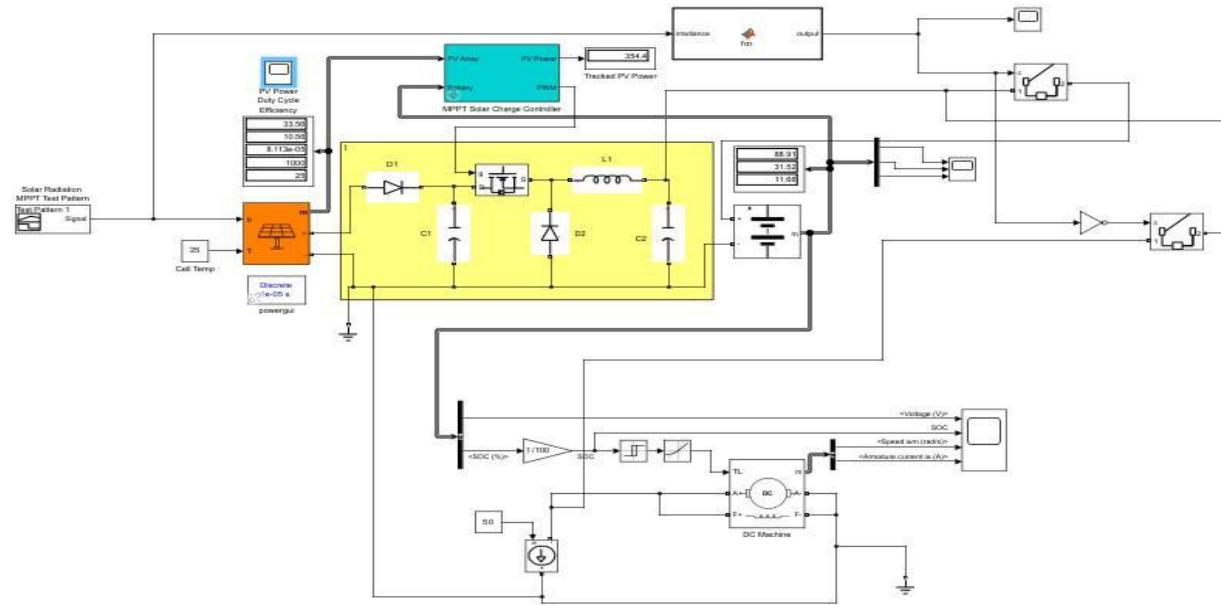

Figure 5- MATLAB model of system

The performance of the proposed control strategy is verified experimentally under intermittent irradiance changes and different loading conditions with a hardware setup shown in Figure 6. Figure 6 shows the hardware implementation of proposed system. The results in this section are based on the assumption of having a constant PV cell temperature of 25 °C.

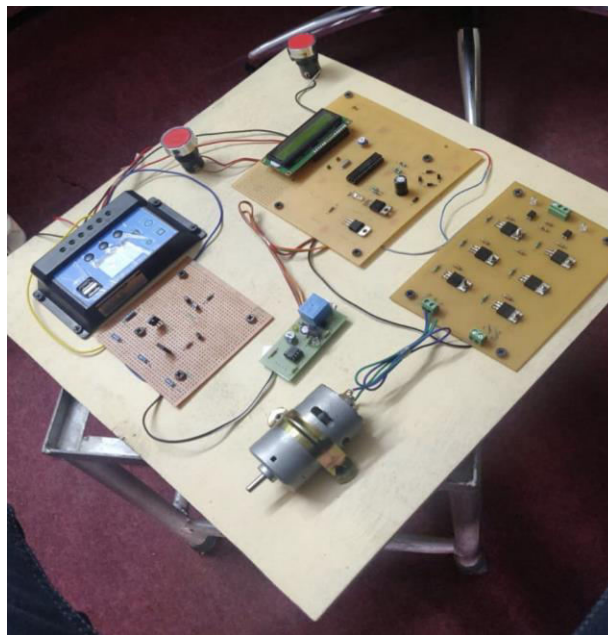

Figure 6 – Hardware Model of the Standalone System through PV system

The results of PV cell is shown in figure 7. The two groups of photovoltaic power generation units are controlled by ATMEGA. As can be seen from figure 7, the two groups of photovoltaic power generation units can track the change in light intensity and always work at the maximum power point to maximize the utilization of photovoltaic energy.

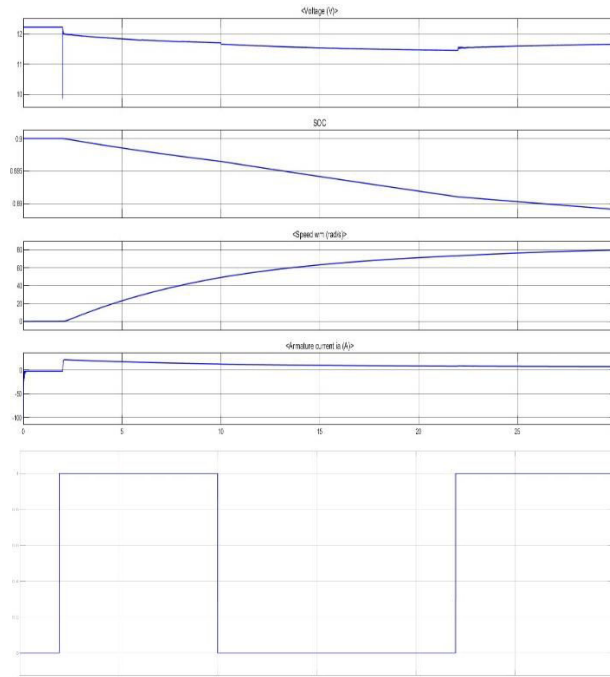

Figure 7 – Output of the MATLAB model

V. CONCLUSION

In this paper, a composite energy storage system consisting of advanced adiabatic compressed air energy storage and storage battery, based on droop control and improved ATMEGA8 control, is proposed for use in the DC microgrid voltage stabilization control process. In this paper, two kinds of energy storage devices are connected to the microgrid, and a DC microgrid model with composite energy storage is built. The effectiveness and reliability of the proposed control strategy has been demonstrated with experimental results and a simulation case study. The results in this section are based on the assumption of having a constant PV cell temperature of 25 °C. The results show that the proposed strategy is able to keep the dc-link voltage close to the desired reference even during transients on load or solar irradiance. The problem of battery degradation is not considered in this paper.

REFERENCES

1. Zheng, L.; Wang, Z.; Lu, S.; Song, J.; Tian, M. Hierarchical Operation Control of Multi-energy Storage in DC Microgrid Based on State of Charge. *Power Syst. Technol.* **2021**, *45*, 1006–1015.
2. Guo, L.; Feng, Y.B.; Li, X.L.; Wang, C. Stability Analysis and Research of Active Damping Method for DC Microgrids. *Proc. CSEE* **2016**, *36*, 927–936.
3. Li, B.; Liu, H.; Kong, X.; Gao, L.; Zhang, W.; Guan, T. Analysis and Prospect of Control Strategies for DC Distribution Systems. *Electr. Power Constr.* **2018**, *39*, 96–108
4. Liu, J.; Zhang, G.W.; Rizzoni, G. Robust stability analysis of DC microgrids with constant power loads. *IEEE Trans. Power Syst.* **2018**, *33*, 851–860.



5. Cao, S.; Ma, X.; Wang, G.; Lin, X.; Li, Z. System-friendly DC Microgrid Coordination Control Strategy Under AC Grid Fault. *Proc. CSEE* **2021**, *41*, 7950–7962.
6. Azab, M.; Serrano, A. Optimal Tuning of Fractional Order Controllers for Dual Active Bridge-Based DC Microgrid Including Voltage Stability Assessment. *Electronics* **2021**, *10*, 1109.
7. Magaldi, G.L.; Serra, F.M.; Cristian, H.d.A.; Montoya, O.D.; Giral-Ramírez, D.A. Voltage Regulation of an Isolated DC Microgrid with a Constant Power Load: A Passivity-based Control Design. *Electronics* **2021**, *10*, 2085.
8. Zhang, Q.; Liu, Z.; Jiang, X.; Peng, Y.; Zhu, C.; Li, Z. Experimental investigation on performance improvement of cantilever piezoelectric energy harvesters via escapement mechanism from extremely Low-Frequency excitations. *Sustain. Energy Technol. Assess.* **2022**, *53*, 102591.
9. Sun, B.; Li, Y.; Zeng, Y.; Chen, J.; Shi, J. Optimization planning method of distributed generation based on steady-state security region of distribution network. *Energy Rep.* **2022**, *8*, 4209–4222.
10. Li, S.; Ye, C.; Ding, Y.; Song, Y. Reliability Assessment of Renewable Power Systems Considering Thermally-Induced Incidents of Large-Scale Battery Energy Storage. *IEEE Trans. Power Syst.* **2022**.
11. Wang, X.; Wang, K.; He, J. Power distribution method of composite energy storage system based on state of charge. *Mar. Electr. Electron. Eng.* **2022**, *42*, 133–136.
12. Li, X.; Liu, J. Real-time power distribution method adopting second-order filtering for hybrid energy storage system. *Power Grid Technol.* **2019**, *43*, 1650–1657.
13. Li, H.; Zhang, Y.; Sun, W. Wind power fluctuation smoothing strategy with generalized energy storage under wavelet packet decomposition. *Power Syst. Technol.* **2020**, *44*, 4495–4504.
14. Yang, X.; Cao, C.; Ren, J.; Gao, F. Control method of smoothing PV power output with battery energy storage system based on fuzzy ensemble empirical mode decomposition. *High Volt. Technol.* **2016**, *42*, 2127–2133.



INNO SPACE
SJIF Scientific Journal Impact Factor
Impact Factor: 8.423



ISSN INTERNATIONAL
STANDARD
SERIAL
NUMBER
INDIA



INTERNATIONAL JOURNAL OF INNOVATIVE RESEARCH

IN SCIENCE | ENGINEERING | TECHNOLOGY

9940 572 462 **6381 907 438** **ijirset@gmail.com**



www.ijirset.com

Scan to save the contact details