



e-ISSN: 2319-8753 | p-ISSN: 2347-6710

IJIRSET

International Journal of Innovative Research in
SCIENCE | ENGINEERING | TECHNOLOGY

INTERNATIONAL JOURNAL OF INNOVATIVE RESEARCH

IN SCIENCE | ENGINEERING | TECHNOLOGY

Volume 12, Issue 13, April 2023

ISSN INTERNATIONAL
STANDARD
SERIAL
NUMBER
INDIA

9940 572 462

6381 907 438

ijirset@gmail.com

www.ijirset.com



IOT Based Remote Patient Health Monitoring System

Dr.G.Ravikumar¹, A.Kameswaran², A.Mathivaanan³, D.Barathan⁴, K.Nagaraj⁵, P.Geetha⁶

¹Professor, Department of ECE, M.P.Nachimuthu M.Jaganathan Engineering College, Erode Dt, Tamil Nadu, India

²Assistant Professor, Department of ECE, M.P.Nachimuthu M.Jaganathan Engineering College, Erode Dt, Tamil Nadu, India

^{3,4,5,6}UG Student, Department of ECE, M.P.Nachimuthu M.Jaganathan Engineering College, Erode Dt, Tamil Nadu, India

ABSTRACT: Today, healthcare has developed science and knowledge based on wireless sensor node technology. Patients who face untimely death from causes such as heart disease and stroke due to inadequate access to emergency medical care. Its purpose is to monitor especially elderly patients and inform doctors and relatives. Therefore, we propose an innovative project to avoid these sudden death rates using a patient health monitoring system that uses sensor technology and uses the internet to communicate with loved ones. In case of an accident. The system uses temperature and heart rate sensors to monitor patient health. Both sensors are connected to his Arduino Uno. Next, in order to monitor the patient's health status, we connect the microcontroller to the LCD screen and connect to Wi-Fi to send the data to a web server (wireless detection button). Patients are alerted via IoT when their heart rate or temperature changes abruptly. The system also displays time-stamped live patient temperature and heart rate data on the connected network. Therefore, an IoT-based patient health monitoring system leverages the Internet to effectively monitor patient health and help users track dormitory work to save lives.

I. INTRODUCTION

Health care facilities always require special care. A database of all patients should serve you well. Either way, you need a way to circumvent the information. Similarly, tolerance information should be kept confidential during the event Social Security is perhaps the most important entitlement issue for many nations in space. Improving the lives of vulnerable segments of society, especially those with chronic diseases, as well as the elderly, those with physical and mental disabilities, will be a future focus. Existing systems store this information when a document is requested or a shared host is searched. However, generally all employees and doctors have access to this information. Then you'll need help recommending acceptable alternative routes. In addition, doctor matching is also possible through flexible requests and web requests. Healthcare facilities need resources to support ongoing screening of patients in need. Heart rate should be monitored continuously. Accessories to test these settings when trading at home may not be available. In addition, there is a high probability that the disease will recur. Patient data (temperature, heart rate, location) are measured continuously and transmitted via an internet server. Delivery times (for example, every 3 minutes) can be localized. Personal authentication has one particularly mild advantage. Roughly speaking, the acceptable normal body temperature is 37°C, and only the Insight feels warm when the body temperature is 37.0°C. Using moderately long averaging techniques, the witness can present these thresholds to the patient.

The same layout as before, advanced mobile phones for doctors, therapists can assess the patient's health. A warning message is displayed for each dive parameter that exceeds critical calculations. Then, with the help of Android accessories, patients have so many smartphones available to their caregivers that even the most tolerant can see their health. Furthermore, detecting life-threatening physiological accident conditions such as heart attack requires continuous monitoring of patient health, simulating clinic-to-home transitions. Studies show that 30% of patients discharged with heart failure require at least 90 interventions within 4-6 months to be readmitted with grades 24-55%. These types of requirements are inconsistent, so health screening frameworks always offer low-cost outcomes. Such constructs also include physiological information that is stored, transformed and associated via nearby means such as a smartphone or personal girlfriend's PC. Such frameworks need further improvement to meet stringent security, reliability, and tolerance requirements that are consistent over time. In the proposed framework, we present a health observation framework that uses sensory nodes to collect information from patients, intelligent



classes to predict people's health status, and a versatile device to bring the senses of doctors. Patients participate in human service processes. Finally, Tom browses across multiple devices so he can edit his health data anytime, anywhere. Today we have to be critics and stars in our daily routine. We need to change the way individuals exist, contemplate, accept and make money. Multiple versions of his web server for motivation, business, career, production, entertainment, social networking, shopping, e-commerce areas, etc.

The next new superweb model is the Web of Things (IoT). Imagine our current reality. A few questions can broadcast the majority of data, talk and challenge. Private web protocol (IP) or open network. These linked questions collect information on a regular basis, examine what is most commonly used to trigger compulsions, and provide a practical system for analyzing, organizing, and making decisions. . These will be the planets of the Network of Things (IoT). Most of these IoTs can be identified in a similar way to web interface questions, and individual questions can also be controlled or remotely monitored using this link. This definition may have already been proposed, but today, the evolution of IoT is needed to enable these machine-on-machine businesses. But the true purpose of IoT may be to create shiny, unobservable systems that can be detected, tuned, and programmed. Outcomes produced in the light of the IoT include embedded technical organizations that can exchange information with each other (not the outcome of the web, but by 2020 there will be 8 billion to more than 50 billion entities with potential associations).). Because these devices are online, a special kind of terminology has been introduced to make them safer, attract more groups and revolutionize social security. The whole idea of IoT is all about sensors, and there are also remote organizations that allow their respective customers to receive additional applications/information.

II. EXISTING SYSTEM

Manual monitoring

Distance between patient and monitoring unit are minimum.

In existing 8051 controller is used.

Single parameter monitoring system.

III. PROPOSED SYSTEM

Remote monitoring

Monitoring the patient as easy one.

In proposed Arduino microcontroller is used.

Multi parameter monitoring system.

IV. PROPOSED SYSTEM METHODOLOGY

The proposed method monitor's health parameters using Arduino Uno. Arduino Uno is a principal controller of our proposed system. The parameters which are monitored in this system are temperature, Heartbeat, MEMS, These parameters are measured using respective sensors and monitored using Arduino Uno, it acts as a server. The data which is monitored by node MCU is showed on the website automatically by the server. Patient's health status can be monitored easily. Detecting, Transport and Application layers are the three layers in the design of IoT applications.

In the detecting layer, we measure the body parameters like temperature, Heartbeat, MEMS.

The process of sending information to the cloud by utilizing Arduino Uno with Wi-Fi module ESP8266 is done in the transport layer. To access the information in the cloud we use open cloud server named "Thing Speak". Thing Speak provides the facility of creating our own account and a channel by the name of our project .To compose information to the cloud we get an id and API-Key

At the Application layer, the information can be recovered using API-Key so as to obtain the information from the server.



BLOCK DIAGRAM

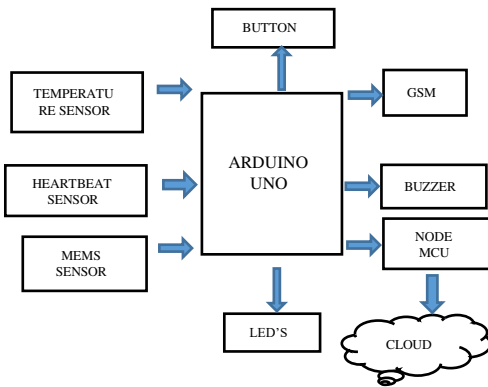

Arduino Uno

Arduino Uno is a microcontroller board based on the ATmega328P. It has 14 digital input/output pins (of which 6 can be used as PWM outputs), 6 analog inputs, a 16 MHz quartz crystal, a USB connection, a power jack, an ICSP header and a reset button. It contains everything needed to support the microcontroller; simply connect it to a computer with a USB cable or power it with a AC-to-DC adapter or battery to get started. You can tinker with your UNO without worrying too much about doing something wrong, worst case scenario you can replace the chip for a few dollars and start over again.

"Uno" means one in Italian and was chosen to mark the release of Arduino Software (IDE) 1.0. The Uno board and version 1.0 of Arduino Software (IDE) were the reference versions of Arduino, now evolved to newer releases. The Uno board is the first in a series of USB Arduino boards, and the reference model for the Arduino platform; for an extensive list of current, past or outdated boards see the Arduino index of boards.

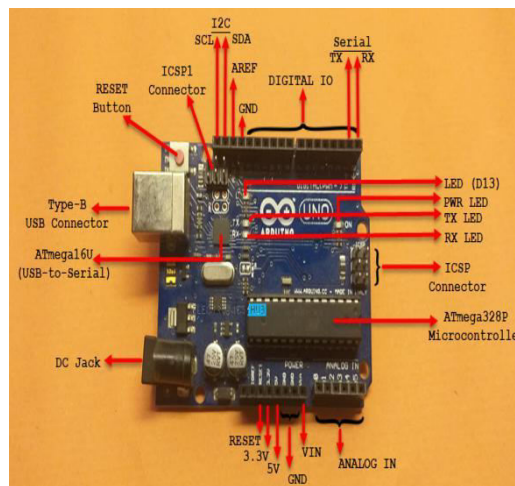

Microcontroller

A micro-controller is a small computer on a single integrated circuit containing a processor core, memory, and programmable input/ output peripherals. The important part for us is that a micro-controller contains the processor (which all computers have) and memory, and some input/output pins that you can control. (often called GPIO - General Purpose Input Output Pins).

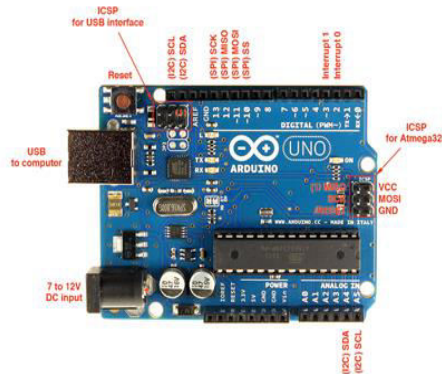

We will be using the Arduino Uno board. This combines a micro-controller along with all of the extras to make it easy for you to build and debug your projects. The Uno is a microcontroller board based on the ATmega328P. It has 14 digital input/output pins (of which 6 can be used as PWM outputs), 6 analog inputs, a 16 MHz quartz crystal, a USB connection, a power jack, an ICSP header and a reset button. It contains everything needed to support the microcontroller; simply connect it to a computer with a USB cable or power it with a AC-to-DC adapter or battery to get started.. You can tinker with your UNO without worrying too much about doing something wrong, worst case scenario you can replace the chip for a few dollars and start over again.

"Uno" means one in Italian and was chosen to mark the release of Arduino Software (IDE) 1.0. The Uno board and version 1.0 of Arduino Software (IDE) were the reference versions of Arduino, now evolved to newer releases. The Uno board is the first in a series of USB Arduino boards, and the reference model for the Arduino platform; for an extensive list of current, past or outdated boards see the Arduino index of boards.

This is a relatively easy way to make circuits quickly. Breadboards are made for doing quick experiments. They are not known for keeping circuits together for a long time. When you are ready to make a project that you want to stay around for a while, you should consider an alternative method such as wire-wrapping or soldering or even making a printed circuit board (PCB). The first thing you should notice about the breadboard is all of the holes. These are broken up into 2 sets of columns and a set of rows (the rows are divided in the middle). The columns are named a, b, c, d, e, f, g, h, i, and j (from left to right). The rows are numbered 1 - 30. (From top to bottom). The columns on the edges do not have letters or numbers. The columns on the edges are connected from top to bottom inside of the breadboard to make it easy to supply power and ground. (You can think of ground as the negative side of a battery and the power as the positive side.) For this book our power will be +5 volts. Inside of the breadboard, the holes in each row are connected up to the break in the middle of the board. For Example: a1, b1, c1, d1, e1 all have a wire inside of the breadboard to connect them. Then f1, g1, h1, i1, and j1 are all connected. But a1 is not connected to f1. This may sound confusing now, but it will quickly come to make sense as we wire up circuits.

Programming

The Uno can be programmed with the Arduino Software (IDE). Select "Arduino Uno" from the Tools > Board menu (according to the microcontroller on your board). For details, see the reference and tutorials.

The ATmega328 on the Uno comes preprogrammed with a bootloader that allows you to upload new code to it without the use of an external hardware programmer. It communicates using the original STK500 protocol (reference, C header files).

You can also bypass the bootloader and program the microcontroller through the ICSP (In-Circuit Serial Programming) header using Arduino ISP or similar; see these instructions for details. The ATmega16U2 (or 8U2 in the rev1 and rev2 boards) firmware source code is available in the Arduino repository. The ATmega16U2/8U2 is loaded with a DFU bootloader, which can be activated by:

On Rev1 boards: connecting the solder jumper on the back of the board (near the map of Italy) and then rise in the 8U2.
On Rev2 or later boards: there is a resistor that pulling the 8U2/16U2 HWB line to ground, making it easier to put into DFU mode.



You can then use Atmel's FLIP software (Windows) or the DFU programmer (Mac OS X and Linux) to load a new firmware. Or you can use the ISP header with an external programmer (overwriting the DFU bootloader). See this user-contributed tutorial for more information.

Node MCU (ESP8266)

The NodeMCU ESP8266 development board comes with the ESP-12E module containing the ESP8266 chip having Tensilica Xtensa 32-bit LX106 RISC microprocessor. This microprocessor supports RTOS and operates at 80MHz to 160 MHz adjustable clock frequency. NodeMCU has 128 KB RAM and 4MB of Flash memory to store data and programs. Its high processing power with in-built Wi-Fi / Bluetooth and Deep Sleep Operating features make it ideal for IoT projects.

NodeMCU can be powered using a Micro USB jack and VIN pin (External Supply Pin). It supports UART, SPI, and I2C interface.

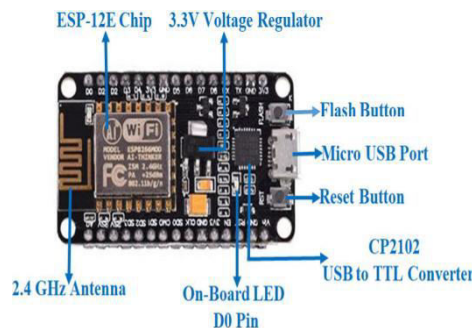

Temperature Sensor - The LM35

The LM35 series are precision integrated-circuit temperature sensors, whose output voltage is linearly proportional to the Celsius (Centigrade) temperature.

You can measure temperature more accurately than using a thermistor.

The sensor circuitry is sealed and not subject to oxidation, etc.

The LM35 generates a higher output voltage than thermocouples and may not require that the output voltage be amplified.

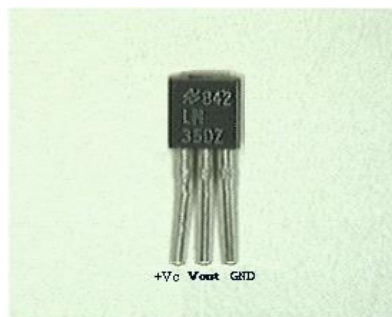

MEMS SENSOR

Breakout board for the 3 axis ADXL335 from Analog Devices. This is the latest in a long, proven line of analog sensors - the holy grail of accelerometers. The ADXL335 is a triple axis MEMS accelerometer with extremely low noise and power consumption - only 320uA. The sensor has a full sensing range of +/-3g. There is no on-board regulation, provided power should be between 1.8 and 3.6VDC. Board comes fully assembled and tested with external components installed. The included 0.1uF capacitors set the bandwidth of each axis to 50Hz.

An accelerometer output value is a scalar corresponding to the magnitude of the acceleration vector. The most common acceleration, and one that we are constantly exposed to, is the acceleration that is a result of the earth's gravitational



pull. This is a common reference value from which all other accelerations are measured (known as g, which is $\sim 9.8\text{m/s}^2$).

The resolution of the data acquired is ultimately determined by the analog to digital converter.

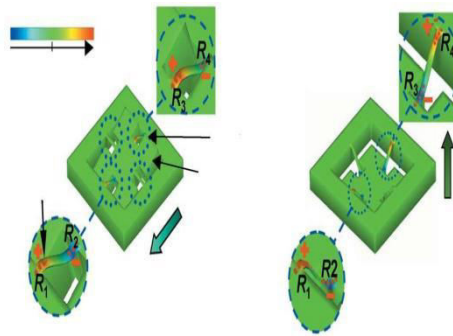

It is possible, however, that the noise floor is above the minimum resolution of the converter, reducing the resolution of your system. Assuming that the noise is equally distributed across all frequencies, it is possible to filter the signal to only include frequencies within the range of operation. The filter required depends upon both the type of acquisition as well as the location of the sensor. The bandwidth is primarily influenced by the three different modes of operation of the sensor.

INTERFACING WITH CONTROLLER

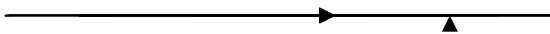

VCC = +5VDC

X-axis = Adc input pin1

Y-axis = Adc input pin2

Z-axis = Adc input pin3

GND = GND

HEARTBEAT SENSOR

The Heart Beat Sensor provides a simple way to study the heart's function. This sensor monitors the flow of blood through ear lobe. As the heart forces blood through the blood vessels in the ear lobe, the amount of blood in the ear changes with time. The sensor shines a light lobe (small incandescent lamp) through the ear and measures the light that is transmitted. The clip can also be used on a fingertip or on the web of skin between the thumb and index finger. The signal is amplified, inverted and filtered, in the box. By graphing this signal, the heart rate can be determined, and some details of the pumping action of the heart can be seen on the graph.

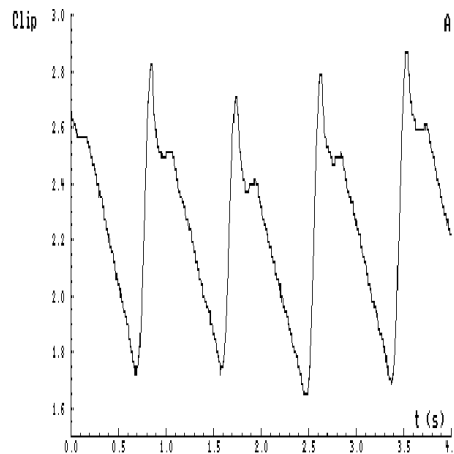
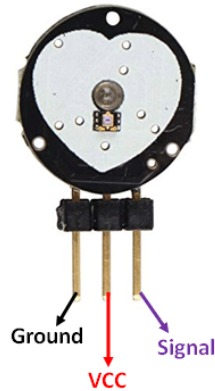

Figure 2-shows that the blood flowing through the earlobe rises at the start of the heartbeat. This is caused by the contraction of the ventricles forcing blood into the arteries. Soon after the first peak a second, smaller peak is observed. This is caused by the shutting of the heart valve, at the end of the active phase, which raises the pressure in the arteries and the earlobe.

The Heartbeat sensor is delivered with a BT-plug and can be connected to the following interfaces:

UIA/UIB through Measuring console (via 0520 adapter)

Coach Lab

Coach Lab II

SMI (via 0520 adapter)

Texas Instruments CBL™ data-logger.

There is an adapter (art. 0520) to connect sensors with BT-plugs to 4-mm inputs.

Improving the results

The sensor has reasonable immunity to disturbances, and so can also be used During exercise, for example on an exercise bicycle. To obtain reliable results it is recommended that:

You move the clip slightly if the signal is poor.

The subject does not move their head greatly, and that the cable is clipped to their clothing.

The ear and clip should be shaded from strong light.

GSM MODEM

Global system for mobile communication (GSM) is a globally accepted standard for digital cellular communication. GSM is the name of a standardization group established in 1982 to create a common European mobile



telephone standard that would formulate specifications for a pan-European mobile cellular radio system operating at 900 MHz

GSM provides recommendations, not requirements. The GSM specifications define the functions and interface requirements in detail but do not address the hardware. The reason for this is to limit the designers as little as possible but still to make it possible for the operators to buy equipment from different suppliers. The GSM network is divided into three major systems: the switching system (SS), the base station system (BSS), and the operation and support system (OSS). The basic GSM network elements are shown in below,

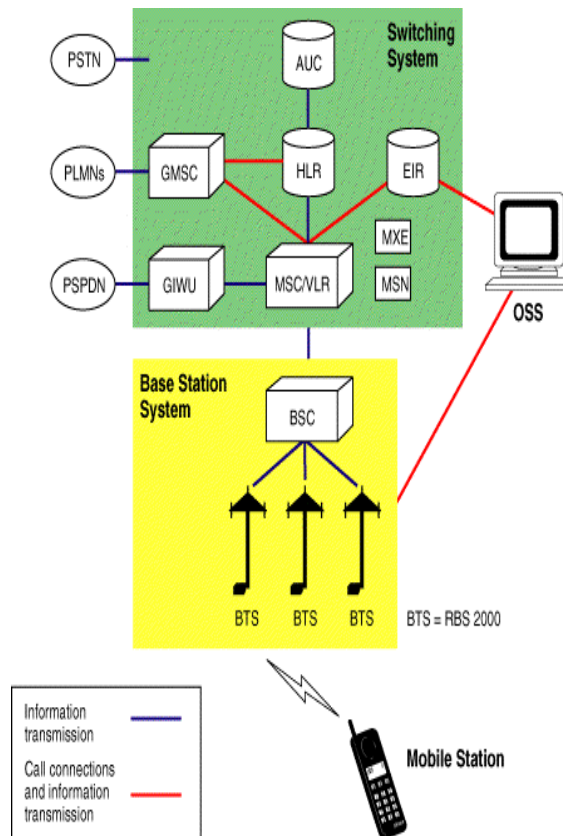

SOFTWARE MODULE

Arduino IDE
 Embedded C Language

Arduino IDE

The Arduino Integrated Development Environment - or Arduino Software (IDE) - contains a text editor for writing code, a message area, a text console, a toolbar with buttons for common functions and a series of menus. It connects to the Arduino hardware to upload programs and communicate with them.



Programs written using Arduino Software (IDE) are called sketches. These sketches are written in the text editor and are saved with the file extension .ino. The editor has features for cutting/pasting and for searching/replacing text. The message area gives feedback while saving and exporting and also displays errors. The console displays text output by the Arduino Software (IDE), including complete error messages and other information. The bottom right-hand corner of the window displays the configured board and serial port. The toolbar buttons allow you to verify and upload programs, create, open, and save sketches, and open the serial monitor.

Embedded C

Embedded C is most popular programming language in software field for developing electronic gadgets. Each processor used in electronic system is associated with embedded software. Embedded C programming plays a key role in performing specific function by the processor. In day-to-day life we used many electronic devices such as mobile phone, washing machine, digital camera, etc. These all device working is based on microcontroller that are programmed by embedded C.

Embedded C is most popular programming language in software field for developing electronic gadgets. Each processor used in electronic system is associated with embedded software. Embedded C programming plays a key role in performing specific function by the processor. In day-to-day life we used many electronic devices such as mobile phone, washing machine, digital camera, etc. These all device working is based on microcontroller that are programmed by embedded C.

Program Logic

Program logic is the plan of trajectory that appears in the theory behind &. Predictable results of program actions. Statements about why embedding programs work Explain Else's theory and show the perceived effect of actions based on other resources.

```
#include
#include
SbitLED=P2^3;
main()
{
LED=0x0ff
delay();
```



```
LEDs=0x00;
#defineLEDP0
Main();
{
LED=0x0ff
delay ();
LEDs = 0x00;
```

Key factors to consider when doing this include:

Program Size All programming languages occupy some amount of memory using embedded processors such as microcontrollers that contain very little random access memory. Program Speed The programming language must be very fast. In other words, it should run as fast as possible. Embedded hardware shouldn't be slowed down by software running slowly. portability similar programs can be compiled for various embedded processors.

V. CONCLUSION

In this article, we present and test a prototype of an automated system that ensures continuous monitoring of various health parameters and prediction of all kinds of diseases and disorders, saving patients from the pain of frequent hospital visits. The proposed system can be installed in hospitals and can collect vast amounts of data and store them in an online database. You can also access your results on mobile via ThinkSpeak software. The system can be further improved by adding artificial intelligence system components to assist doctors and patients. For example, if a patient's health parameters change according to the same pattern as previous patient health parameters in the database, the outcome can also be estimated. If you have a similar pattern found repeatedly, it would be easier for the doctors and medical researchers to find a remedy for the problem.

REFERENCES

- [1]<http://www.instructables.com/id/HealthBand/>
- [2] Temitope O. Takpor and Aderemi A. Atayero, "Integrating Internet of Things and eHealth Solutions for Students' Healthcare", WCE 2015, July.
- [3] <https://pulsesensor.com> Fig.4. Displaying temperature value on the cloud. Fig.5. Displaying pulse value on the cloud. Fig.6. Live values displayed in an android application. Fig. 7. SMS with pulse and location link. IEEE International Conference on Power, Control, Signals and Instrumentation Engineering (ICPCSI-2017) 1686
- [4] <https://www.sparkfun.com/products/11574>
- [5]<https://www.elprocus.com/heartbeat-sensor-workingapplication/>
- [6]<https://www.sparkfun.com/products/8777>
- [7]https://www.espressif.com/sites/default/files/0aesp8266ex_datasheet_en_1.pdf



INTERNATIONAL JOURNAL OF INNOVATIVE RESEARCH

IN SCIENCE | ENGINEERING | TECHNOLOGY

 9940 572 462  6381 907 438  ijirset@gmail.com



www.ijirset.com

Scan to save the contact details