



e-ISSN: 2319-8753 | p-ISSN: 2347-6710

# IJIRSET

International Journal of Innovative Research in  
**SCIENCE | ENGINEERING | TECHNOLOGY**

# INTERNATIONAL JOURNAL OF INNOVATIVE RESEARCH

IN SCIENCE | ENGINEERING | TECHNOLOGY

Volume 12, Issue 6, June 2023

**ISSN** INTERNATIONAL  
STANDARD  
SERIAL  
NUMBER  
INDIA

Impact Factor: 8.423

9940 572 462

6381 907 438

[ijirset@gmail.com](mailto:ijirset@gmail.com)

[www.ijirset.com](http://www.ijirset.com)



# Energy- Efficient Integration of a Database and a Light Enabled Patient Monitoring System

Shubhada Japhne G<sup>1</sup>, Elza Melif M<sup>2</sup>, Thanushya J<sup>3</sup>,

PG Student, Department of Computer Science and Engineering, PET Engineering College, Tirunelveli, India<sup>1</sup>

Assistant Professor, Department of Computer Science and Engineering, PET Engineering College,  
Tirunelveli, India<sup>2</sup>

Assistant Professor, Department of Computer Science and Engineering, PET Engineering College,  
Tirunelveli, India<sup>3</sup>

**ABSTRACT** - Patient monitoring system using Li-Fi technology. Li-Fi stands for Light Fidelity. Li-Fi technology was invented and developed by the German Physicist Harold Haas provides transmission of knowledge through illumination by sending data through varies intensity faster than human eye can follow. Li-Fi may be a bidirectional, high speed and fully networked wireless optical communication and may be a sort of light communication. The proposed model helps within the patient monitoring within the hospitals and may be done by using the concept of Li-Fi rather than Wi-Fi technology to avoid the frequency interference with the human body. Sensors such as temperature, heartbeat, motion, are used in the prototype to perform its respective functions. These sensors collect the data from the human body and then the data is sent to the ATmega8 microcontroller and then it converts digital signal into optical signal which is emitted by led or lasers and at the receiving end we have photo detectors to receive the light emitted signals and then it sent to another micro controller and then its connected to PC or display where it shows the readings of all the sensors attached to the patient's body.

**KEYWORDS:** Patient monitoring, Li-Fi, Sensors, LED, IoT, Light communication.

## I. INTRODUCTION

The upcoming world needs easy and reliable solutions for patient monitoring systems, so here is the prototype proposed by me on Li-Fi based patient monitoring system. This helps to monitor patients anywhere from any remote location. The main reason to use this technology is that this Li-Fi does not emit any harmful electromagnetic radiations which harms to human body it uses the same led lops which we normally use in our house so in ICU where such electromagnetic radiations are prohibited so doctors have to physically go and monitor the readings but in many cases there is chance to doctors get infected by such harm full disease and there are other circumstances too which can also cause damage to patient so it's advisable to monitor patient outside the ICU. So, I have prototyped the device which can transmit and receive the patient monitored data wirelessly using LED and lasers and it uses Li-Fi technology so the electromagnetic radiation is not harmful for the human body so it can also be used in intensive care unit (ICU) too.

Li-Fi communicate information all the alignment via sending fiber optics and produce fiber from it information in course of LED light changes which is faster than the human eye. Firstly this definition was used by herald has in visible light communication, If LED is ON, we transmit 1, if it is off it will transmit 0. Harald has said rapidly if there is exchange in ON and OFF it transmit data at open doors. We can flexibly encode information from light by changing rate of LED's, firstly where ON and OFF is the series of 1's and 0's. Dependency on the wireless internet increases the burden on Wireless Fidelity (Wi-Fi) technology which, in turn, creates a huge demand for bandwidth and radio spectrum. For a long time, medical technology has lagged behind the rest. The scope for wireless communication in the medical field is set on the rise, there are many devices which work on Wi-Fi such as infusion pumps, defibrillators, lung ventilators, and anesthesia machine. When a doctor is supposed to use magnetic resonance imaging scanners along with infusion pumps, which work on Wi-Fi there results a frequency overlapping problem. With more and more number of wireless medical devices coming up, utilizing the radio frequency (RF) spectrum increases which lead an electromagnetic interference (EMI) that results in potentially hazardous events related to medical equipment operations. Apart from the interference with medical equipment, an EMI affects human body also in the form of diseases, immune dysfunction, electromagnetic hypersensitivity, etc., and in worst case, it may lead to cancer. Another limitation of Wi-Fi in hospital system is its security issue. Patient information must be private and secure but remain accessible to authorized persons. Hospitals are places where both EMI sensitivity and security of medical details are issues with the uses of Wi-Fi. Not only improving the patient's health conditions but also communications among the physicians and

clinicians. Wireless technology with Li-Fi system enables clinicians to monitor patients remotely and give them timely health information, reminders, and support. Li-Fi technology ameliorates medical field to the next level and has a plethora of merits when installed and used beneficially.

## II. REVIEW OF LITERATURE

R. Bhavya and R. Lokesh, (2016), A Survey on Li-Fi Technology, An International Journal of Engineering & Technology Vol 3, Num 1, pp.7-12.

They studied the design of Li-Fi as a new wireless technology which works in providing connectivity within a prescribed network environment. The working of this technology is very unique Because It provides transfer of data by sending information through an LED that varies in intensity so fast that the human eye cannot follow. Haas's invention, DLIGHT could produce data rates more than 10 Mb/s, which is faster than an average broadband connection[2]. Finally, the authors have predicted the brighter future scope of this technology for using visible light as a transporter in data transfer and networking.

A. Chandankhede ,M.AdkineSutone ,A.Makhe, 2015, Light,International Research Journal of Engineering and Technology , Vol. 03, Issue: 03,PP. 660-664.

They deal with the issues of capacity of High Bandwidth, availability of light sources and security present in Wi-Fi technology by coming up with a concept of transferring data through light using sources like LED's. And the authors further describes the design of this technology as an indoor visible data transmission system using LEDs which is applied for the purpose for lighting the rooms, as well as for creating an optical communication system. So Li-Fi technology works for solving the problem of lack of spectrum space and for a communication at very high speed. By this project, the authors came to a conclusion that Li-Fi can be used as a very good medium for transmitting data between systems which will lead us to a cleaner, greener, safer and brighter future.

B.ANIL, D.JANARDHANA and L.CHAYADEVI,(2015), A Survey on WIFI and LIFI technologies , Anil Computer Technology & Applications, Vol 6 , No.(6),PP.1047-1051, 2015.

They revealed the design and described the working of LiFi Technology and the authors compared the two technologies in the present scenario and gave its applications. Wi-Fi is used widely in each and every environment but in recent times many researches are going on Li-Fi technology. Li-Fi technology may not be so effective in order to replace old styled radios altogether, but it could give a rapid push to the development of devices like wireless television and The authors discovered a big disadvantage of Wi-Fi is that finding the ideal position for the placement of a wireless router from where it could cover the desired area. Some of the advantages of Wi-Fi discussed by the authors are its convenience, its mobility, many clients can be given access etc.

F. Kalyani, M. Khakhariya and D. Nandy,(2016), LI-FI: Light Fidelity– a critical technical study, Proceedings of International Conference on Computer Science Networks and Information Technology Held on 23rd-24th January 2016, n Pattaya ,PP.41-43.

They explained the design of Li – Fi as a completely networked wireless technology that makes usage of light waves as a substitute of radio waves to deliver data. Li – Fi works on visible light communication (VLC) or infra-red spectrum which carries much more data, and has been offered as a substitute to the Radio Frequencies-bandwidth limitations. they focused on the Li – Fi technology, its advantages and challenges over Wi – Fi. It is a disadvantage for Wi-fi that the technology is more costly and provided slower data transmission rate.

## III. PROPOSED SYSTEM

In the proposed system the patient is monitored using Li-Fi instead of Wi-Fi. It reduces the radio interference in the human body. Patient is monitored using different sensors like temperature, heart beat and motion sensor. The sensed data is then converted into digital form in the microcontroller. The output of the microcontroller is sent to the Li-Fi module. The data is then transmitted in the form of light through the Li-Fi module and detected in the receiver side by the photo detector[6]. The received is sent to the concerned person through IOT. The concerned person can access the data of the patient using the mobile application data monitoring using Li-Fi. The working of the Li-Fi module is very simple. It uses the concept of LEDs where logic 1 represents the data transmission and logic 0 represents that there is no transfer of data. The patient monitoring using the Li-Fi is done with the help of sensors. The sensors that are used in this model are temperature and heart beat which will perform its necessary function. The sensed data are converted into the digital form using the analog to digital converter which is inbuilt in the microcontroller. The data is then transmitted in the form of light through the Li-Fi module. The on and the off of the lights indicates the presence and the absence of the information. Rapid pulses are generated by the flickering of these LEDs which produces string of 0s and 1s.The



light is detected in the receiver side by the photo detector. The light fidelity can act as illumination as well as data transmission which is an efficient alternative[3]. The main components of this communication system are LED, which acts as a Transmitter source. Photodiode shows good response to visible wavelength region serving as the receiving element.

#### IV. METHODOLOGY

Li-Fi is typically implemented using white LED light bulbs at the downlink transmitter. The operational procedure is very simple, data from the internet and local network is used to modulate the intensity of the LED light source if any undetectable to the human eye[5]. The photo detector picks up signal, which is converted back into a data stream and sent to the client. The client can communicate through its own LED output or over the existing network. An overhead lamp fitted with an LED with signal-processing technology streams data embedded in its beam at ultra-high speeds to the photo-detector. A receiver dongle then converts the tiny changes in amplitude into an electrical signal, which is then converted back into a data stream and transmitted to a computer or mobile device[12].

#### SYSTEM ARCHITECTURE

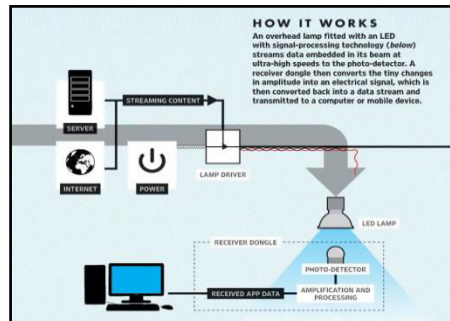

Fig 4.1 Data Transmission Using LED

#### Methods of Visible Light Communication

- Devices used for Visible Light Communication.
- Communication using Image Sensors.

#### BLOCK DIAGRAM

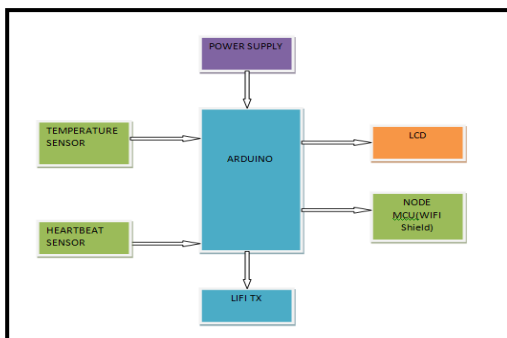

Fig 4.2 Transmitter section

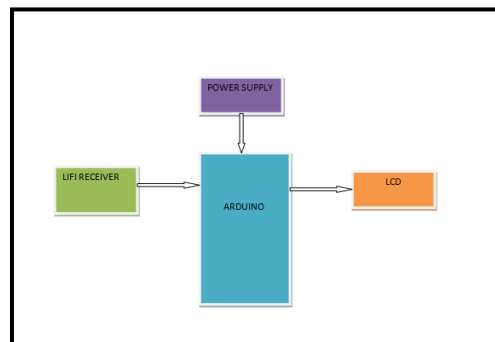

Fig 4.3 Receiver Section

#### V. MODULES

**POWER SUPPLY:** The ac voltage, typically 220V rms, is connected to a transformer, which steps that ac voltage down to the level of the desired dc output. A diode rectifier then provides a full-wave rectified voltage that is initially filtered by a simple capacitor filter to produce a DC voltage[11]. This resulting dc voltage usually has some ripple or ac voltage variation. A regulator circuit removes the ripples and also remains the same dc value even if the input dc voltage varies, or the load connected to the output dc voltage changes. This voltage regulation is usually obtained using one of the popular voltage regulator IC units.

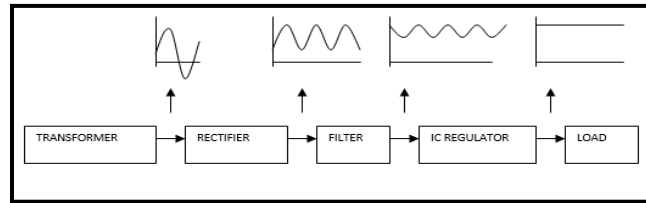

Fig 5.1 Block Diagram of Power supply

Working principle:

**Transformer:** The potential transformer will step down the power supply voltage (0-230V) to (0-6V) level. Then the secondary of the potential transformer will be connected to the precision rectifier, which is constructed with the help of op-amp[5]. The advantages of using precision rectifier are it will give peak voltage output as DC, rest of the circuits will give only RMS output.

**Bridge rectifier:** When four diodes are connected as shown in figure, the circuit is called as bridge rectifier.

The input to the circuit is applied to the diagonally opposite corners of the network, and the output is taken from the remaining two corners. The positive potential at point A will forward bias D3 and reverse bias D4. The negative potential at point B will forward bias D1 and reverse D2. At this time D3 and D1 are forward biased and will allow current flow to pass through them; D4 and D2 are reverse biased and will block current flow. The path for current flow is from point B through D1, up through RL, through D3, through the secondary of the transformer back to point B. this path is indicated by the solid arrows. Waveforms (1) and (2) can be observed across D1 and D3[10].

One-half cycle later the polarity across the secondary of the transformer reverse, forward biasing D2 and D4 and reverse biasing D1 and D3. Current flow will now be from point A through D4, up through RL, through D2, through the secondary of T1, and back to point A. This path is indicated by the broken arrows. Waveforms (3) and (4) can be observed across D2 and D4. The current flow through RL is always in the same direction. In flowing through RL this current develops a voltage corresponding to that shown waveform (5). Since current flows through the load (RL) during both half cycles of the applied voltage, this bridge rectifier is a full-wave rectifier. The maximum voltage that can be rectified is the full secondary voltage, which is 1000 volts

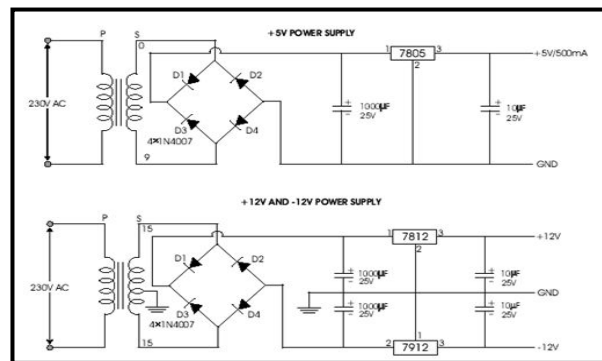

Fig 5.2 Circuit Diagram of Power Supply

**MICROCONTROLLER:** Microcontroller can be described as a computer embedded on a rather small circuit board. To describe the function of a microcontroller more precisely, it is a single chip that can perform various calculations and tasks, and send/receive signals from other devices via the available pins. It is this job of telling the chip what to do, is what we refer to as programming on it. The actual microcontroller is the heart in the chip called Atmega328[7].

**Temperature sensor:** Temperature is generally sensed by humans as “hot”, “neutral”, or “cold”, chemical engineering requires precise, quantitative measurements of temperature in order to accurately control a process. This is achieved through the use of temperature sensors, and temperature regulators which process the signals they receive from sensors. There are 2 kinds on temperature sensors: 1) contact sensors and 2) noncontact sensors

**Contact Sensors:** Contact temperature sensors measure the temperature of the object to which the sensor is in contact by assuming or knowing that the two (sensor and the object) are in thermal equilibrium, in other words, there is no heat flow between them. Example: Thermocouples, Bimetallic Thermometers.



**Noncontact Sensors:** Most commercial and scientific noncontact temperature sensors measure the thermal radiant power of the Infrared or Optical radiation received from a known or calculated area on its surface or volume within it[8]. Example: Pyrometer.

**Heartbeat Sensor:** Heart beat monitoring means to measure how many heart beats are present per minute. Heartbeat monitoring is done using heartbeat sensors. Heartbeat sensors are designed to give digital output. The heartbeat is detected when a finger is placed on it.

**LIFI:** Light Fidelity (Li-Fi) technology is a wireless communication system based on the use of visible light. There is a light emitter on one end i.e. an LED transmitter, and a photo detector (light sensor) on the other[9]. The data input to the LED transmitter is encoded in to the light (technically referred to as Visible Light Communication) by varying the flickering rate at which the LEDs flicker ‘on’ and ‘off’ to generate different strings of 1s and 0s[14]. The on/off activity of the LED transmitter which seems to be invisible (The LED intensity is modulated so rapidly that human eye cannot notice, so the light of the LED appears constant to humans), enables data transmission in light form in accordance with the incoming binary codes: switching ON a LED is a logical '1', switching it OFF is a logical '0'. By varying the rate at which the LEDs flicker on and off, information can be encoded in the light to different combinations of 1s and 0s.

**IOT(NODE MCU):** Wi-Fi chips are a quite lesser in cost than compared to other contemporary chips which has in built MCU and TCP/IP layer. Several automation systems in Electrical & medical make use of NodeMCU Wi-Fi Chips[9]. The proposed Surveillance and control system in this paper is divided into two categories, premise & one directional though both the categories have same purpose but differ in the system design. One directional focuses mainly on long distance control like traffic signals which works on LoRa through its Master Controller (Raspberry Pi). This pi has several input/output pins which are connected to devices. Further pi is connected to Cloudserver to process the data and send information to end user in mobile or web application[15]. On premise uses NodeMCU module to communicate to Master controller over the HTTP protocol through internet to detect the faulty devices in the system. TCP/IP protocol that can give any microcontroller entrance to the Wi-Fi network that supports 2.4 GHz Wi-Fi (802.11 Wi-Fi standards).

**Liquid Crystal Display:** Liquid Crystal Displays can be difficult to drive because they require multiplexing, AC drive waveforms, and special voltages. LCD modules make this driving simpler by attaching hardware to the raw glass LCD to assist in some or all of these rudimentary driving tasks. LCD modules can be split into two groups: those that have built-in controller and driver chips, and those that have only driver chips.

## VI. RESULTS AND DISCUSSION

Serial No.	TEMPERATURE	HEARTBEAT	time
1	29	86	March 26 2023 11:18
2	29	81	March 26 2023 11:18
3	29	99	March 26 2023 11:18
4	29	85	March 26 2023 11:18
5	29	92	March 26 2023 11:18

Fig 6.1 Monitoring Section

The database provides the information about the patients. It has two sections. The monitoring section shows the sensed temperature and heartbeat with the appropriate date and time.

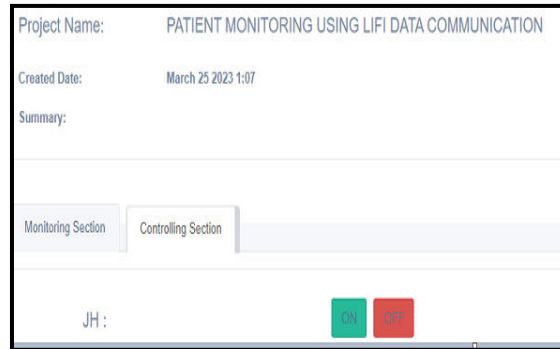

Fig 6.2 Controlling Section

In this section, we can control the patient monitoring database. It has two options as on and off. We can control based on our needs.



Fig 6.3 Line View

This represents the sensed temperature and heartbeat in a line view format.

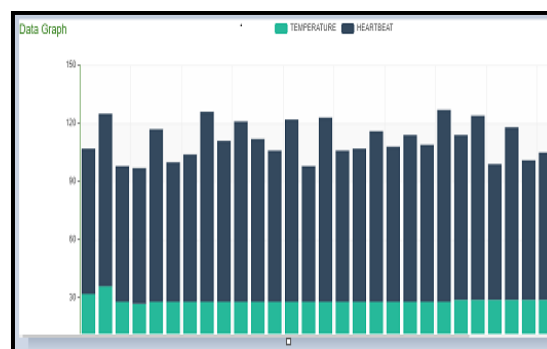

Fig 6.4 Graph View

The sensed temperature and heartbeat is represented in graph view.

## VII. CONCLUSION AND FUTRURE ENHANCEMENT

We have been able to transfer the text, temperature recorded voice on the receiver side through the help of light source which is present on the transmitter side. A proper the temperature is detected accurately and the text is displayed exactly. The future scope of this technology is very bright. The solution of the problem dealing with the integration of visible light with a communication system is demonstrated here. This system can be used with the present infrastructure, without undergoing major changes. Visible Light Communication is a rapidly growing technology in the field of wireless communications. As there are many challenges in this field but there are equal or more advantages with it as well. With the introduction and usage of VLC, many of our long-faced problems such as power and



environmental issues can potentially be solved. The VLC is still in its beginning stage, but with the rapid improvements being made in this technology stage by stage, it will be used in our daily life soon. In spite of the research problems, it is our belief that VLC system will become one of the most promising and prominent technologies in the field of wireless communication for the future generations. Camera and video transmission can be added in our future prospect with the robotic vehicle. Improving the weight capacity of the robotic vehicle.

#### VIII. ACKNOWLEDGEMENT

I would like to express my sincere thanks to Elza Melif M and Thanushya J for her valuable guidance and support in completing this article. I would also like to express my gratitude towards our College.

#### REFERENCES

- [1]. Ashmita Shetty, 2016 “A Comparative Study and analysis on Li-Fi and Wi-Fi”, International Journal of Computer Applications Vol 150, no.6, September.
- [2]. X. Liang, M.Yuvan, J.Wang, M.Jiang and C.Zhao, “Constellation design enhancement for color shift keying modulation of quadrichromatic LEDs in visible light communication,” J.Lightw Technol., vol.35, no.17, pp.3650-3663, Sept.1, 2017.
- [3]. Luis Bica Oliveira, Nuno Paulino, João P.Oliveira, Rui Santos, Nuno Pereira and João Goes, 2016 “Undergraduate Electronics Projects Based on the Design of an Optical Wireless Audio Transmission System”, IEEE, 0018- 9359 ©
- [4]. “High-speed indoor visible light communication transceiver-System architecture, physical layer and data link layer specification,” Int.Telecommun. Union, Geneva, Switzerland, ITU-T Recommendation G.9991, Mar.2019.
- [5]. Priyanka M, Anisha S and Sakthi Prabha R. 2016 “ VLSI Design For A Pso-Optimized RealTime Fault-Tolerant task allocation algorithm in Wireless Sensor Network,” ARPJ Journal of Engineering and Applied Sciences Vol. 11, no. 13, July 2016 ISSN 1819-6608
- [6]. Zashi P. Choudhari and Satish R. Devane, 2016” High sensitivity universal Lifi receiver for enhance data communication” Online Int. Conf. on Green Engineering and Technologies(ICGET) 978-1-5090-4556-3/16/\$31.00 © IEEE
- [7]. Gurbinder Singh, 2015 “Li-Fi (Light Fidelity) - An Overview to future Wireless technology in Field of Data Communication”, Journal of Network Communications and Emerging Technologies (JNCET) Vol 5, issue 1, November
- [8]. R.Sakthi Prabha, 2019 “Channel aware reputation system with adaptive detection using AODV protocol during forward attack in wireless sensor network”, IOP Conf. Series: Materials Science and Engineering 561 (2019) 012121 DOI:10.1088/1757- 899X/561/1/012121
- [9]. Xu Bao, Guanding Yu, Jisheng Dai and Xiaorong Zhu, 2015 “Li-Fi: Light fidelity-a survey”, January
- [10]. F Ciprian G. Gavrinca, Jorge Baranda, and Pol Henarejos, 2014 ” Rapid Prototyping of Standard- Compliant Visible Light Communications System” IEEE Communications Magazine, July
- [11]. A.Gupta and P.Garg, “Statistics of SNR for an indoor VLC system and its applications in system performance,” IEEE Commun. Lett., vol.22, no.9, pp.1898-1901, Sept 2019.
- [12]. D.Bertsekas and R.Gallager, Data Networks, 2nd ed. Englewood Cliffs, NJ, USA: Prentice-Hall, 2020.
- [13]. Light Communication Alliance. Accessed: Aug 25, 2021 [Online]. Available: <http://lightcommunications.org>
- [14]. A. Shahini, A.Kiani and N.Ansari, “Energy efficient resource allocation in EH-enabled CR networks for IOT”, IEEE Internet Things J., vol.6 no.2, pp. 3186-3193, Apr 2021.
- [15]. L.E.M Matheus, A.B. Vieira, L.F.M. Viera, M.A.M Vieira and O.Gnawali, “Visible Light Communication: Concepts, applications and challenges,” IEEE Commun. Surveys Tuts, vol.21, no.4, pp. 3204-3237, 4<sup>th</sup> Quart., 2019.





**INNO SPACE**  
SJIF Scientific Journal Impact Factor  
**Impact Factor: 8.423**



**ISSN** INTERNATIONAL  
STANDARD  
SERIAL  
NUMBER  
INDIA



# INTERNATIONAL JOURNAL OF INNOVATIVE RESEARCH

IN SCIENCE | ENGINEERING | TECHNOLOGY

**9940 572 462** **6381 907 438** **ijirset@gmail.com**



[www.ijirset.com](http://www.ijirset.com)

Scan to save the contact details