



e-ISSN: 2319-8753 | p-ISSN: 2347-6710

IJIRSET

International Journal of Innovative Research in
SCIENCE | ENGINEERING | TECHNOLOGY

INTERNATIONAL JOURNAL OF INNOVATIVE RESEARCH

IN SCIENCE | ENGINEERING | TECHNOLOGY

Volume 12, Issue 9, September 2023

ISSN INTERNATIONAL
STANDARD
SERIAL
NUMBER
INDIA

Impact Factor: 8.423

9940 572 462

6381 907 438

ijirset@gmail.com

www.ijirset.com

Comparative Analysis of Curved Beam with Transverse Circular Openings in Different Positions Using ANSYS Software

Anup T Sogi¹, A R Chandrashekar²

M. Tech. in Structural Engineering, Department of Civil Engineering, Bapuji Institute of Engineering and Technology, Davangere, Karnataka, India

Assistant Professor, Department of Civil Engineering, Bapuji Institute of Engineering and Technology, Davangere, Karnataka, India

ABSTRACT: The Project aims the study of various opening positions on the shear behaviour of considered elements of beams without the use of extra shear reinforcement around the openings. ANSYS 2019 R2 software is utilized for nonlinear analysis of the beams. The primary purpose of having transverse web openings which is present in reinforced concrete considered in the beams is to accommodate services such as telephone lines, air conditioning, and ventilating ducts passing through the structure. However, considered conditions of the openings can lead to certain challenges, including increased stress concentrations, potential oblique cracks near the openings, and weakened regions in the beam. As a consequence, the bearing capacity and load-carrying mechanism which may be compromised. The importance of considering safety measures to prevent accidents, given the potential decrease in the structural integrity of the beam. Presumably, the research in the thesis aims to shed light on the behaviour and provide insights into their performance under different opening positions, ultimately leading to safer and more reliable design practices. Effects of opening size and location, the size and location of the transverse web opening can significantly influence the beams structural performance. Larger openings or those closer to the supports may lead to more pronounced effects on the beam's strength and stiffness. Design Guidelines and Code Provisions are, the thesis might discuss relevant design guidelines and code provisions for reinforced concrete beams with transverse web openings. It's essential to adhere to specific code requirements to ensure the safety and reliability of the structure. Mitigation Measures are, the research may propose possible mitigation measures to enhance the structural integrity of beams with openings. This could include using additional shear reinforcement around the openings or modifying the beam's design to minimize stress concentrations.

KEYWORDS: ANSYS 2019 R2, Nonlinear analysis, Transverse web opening.

I. INTRODUCTION

In engineering and structural analysis, understanding the behaviour of complex structures very important for efficiency and safety. Curved beams with different opening locations are commonly used in various industries, from aerospace to civil engineering. Analysing proper loading is essential to make informed design decisions. This study focuses on the structural analysis of a curved beam with three different opening positions at $L/3$, $L/2$ (i.e., midspan) and shear zone. The objective is to compare and evaluating results of these opening shapes on stress, strain, and total deformation in the beam. To achieve this, where we use the software known as the ANSYS will be employed. The curved beam will experience static loading conditions that commonly found in its intended use. The material properties will be constant for all the three models to isolate the influence of the opening locations on the beam's behaviour. This analysis aims to identify which opening location provides the best structural performance in terms of stress distribution, strain levels, and total deformation. The results will aid engineers and designers in When choosing options, it is crucial to make well informed decisions. the most suitable opening location for a specific application. Before delving into the detailed analysis, studying the theoretical background of curved beams, the Finite Element Method, and the significance of stress, strain, and deformation in structural analysis. By studying these aspects behaviour elements of beam having different opening locations and draw meaningful conclusions from the subsequent simulation results.

II. RELATED WORK

- 1. Amar Faruq izzat and hider Abdul Wahid khalif (2020).** The concept of curved beams with different opening locations we referred by Amar Faruq izzat and hider Abdul Wahid khalif This study examines the behaviour of simply-supported rectangular section beams with multiple openings, focusing on practical and constructional benefits. The beams were divided into three groups: rectangular, circular, and parallelogram. Circular openings were found to be more efficient in terms of ultimate load capacity and beam rigidity, while beams with parallelogram openings outperformed rectangular openings. The ultimate capacity of load-carrying beams decreased from 75% to 93%, 65% to 93%, and 70% to 79%, respectively.
- 2. Dawood mostofinejhad (2020).** The paper "Analytical Study of Shear Behaviour of RC beam with Varying Shapes of Web Opening" explores the impact of different opening shapes on shear behaviour and the conditions of shear reinforcement at the sides of the openings. The beams were analysed using ANSYS software and tested under point loading with a simple supported condition. The ultimate load-carrying capacity for each opening shape was found to be 120 kN for circular openings (18.4% very low compared to no openings), 119 kN for elliptical openings (19% very low compared to no openings), 117 kN for square openings (19% very low compared to no openings), 116 kN for hexagonal openings (20% very low compared to no openings), and 115 kN for rectangular openings (21% very low compared to no99).
- 3. Athira Boselal, Archana Sukumaran (2018).** The research investigated the strengthening of reinforced concrete semicircular curved beams using laminates like GFRP, BFRP, and CFRP. The beams, with circular and rectangular openings, were tested under 10kN conditions. The beams had a diameter of 2m and an outside diameter of 2.25m. The beams were strengthened using different laminates to improve their load-carrying capacity and structural performance. The study was conducted using ANSYS software for structural simulations.
- 4. Subhajit Mondal, Bandyapadhy J. N, Chandra Pal Gautam (2011).** The study aimed to understand the behaviour of RC deep beams with circular openings. Thirteen beams with lengths of 1m and dimensions of 100mm x 400mm were selected for the study. Steel bearing plates with dimensions of 60x30x100mm were used for loading values. Finite Element Software (FEM) was used to evaluate stress and deformation, and the study aimed to determine the impact of openings on the beams' ultimate shear strength. This allowed the researchers to understand the effects of openings on the beams structural capacity.

III.METHODOLOGY

Ansys is the important analysis software and it used FEM technology, so design and analysis. ANSYS is developed and distributed by ANSYS Inc., a prominent engineering simulation company. ANSYS 19.2 is an older release of the software, and it was released as part of the ANSYS 19.2 series. Each new version of ANSYS typically introduces enhancements, improvements, and new features to provide more accurate and efficient simulations for various engineering disciplines.

Steps Involved in Analysis:

1. Modelling
2. Dimensional Details
3. Material Properties
4. Meshing and Loading
5. Analysis of Beams

Modelling:

The curved beam having a size of 328x120mm modelled with circular opening of 50mm at different positions is modelled using Catia software and imported into Ansys for further design and analysis. Meta data is provided for analysis and design.

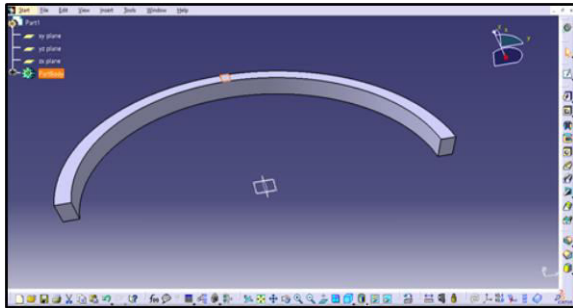

Fig 3.1. Model with no opening

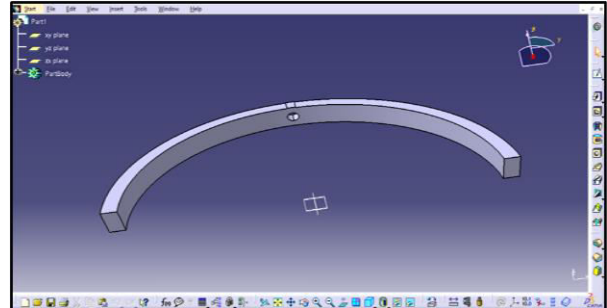

Fig 3.2. Model with circular opening at midspan

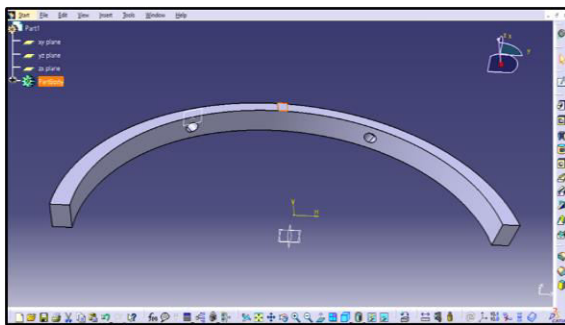

Fig 3.3. Model with openings at L/3

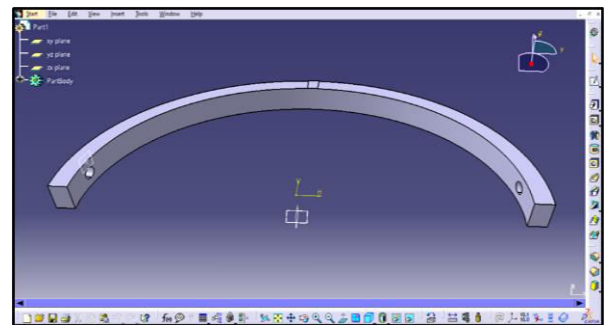

Fig 3.4. Model with Circular Openings nearer to Support

Dimensions of the Curved Beam:

- Curvature length of beam [L]:4571mm
- Beam width [b]: 120mm
- Beam depth [d]: 238mm
- Inner radius of the curved beam [R1] :1380mm
- Outer radius of the curved beam [R2] :1500mm
- Distance between supports :2760mm
- Diameter of the Opening :50mm
- Bearing Size :50.59x120mm

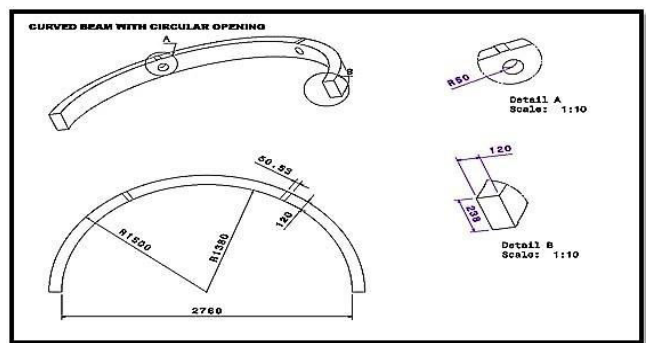

Fig 3.5. Geometric Dimensions

Material properties:

To avoid contact region errors, calculate material properties of M45 grade concrete and FE550 grade steel using given ranges and assign them to the ANSYS model (Refer Table 1).

Material	Density KG/M3	Youngs modulus	Poisson ratio	Compressive strength (PA)	Tensile strength
Concrete	2390	1.70E+10	0.18	49125000	2.50E+06
Steel	7850	2.10E+11	3.00E-01	5.50E+08	5.85E+08

Table 1: Material properties.

Meshing:

The 2D mesh is a combination of small, interconnected elements that cover the entire 2D surface of the object being watched. These elements can be triangles, quadrilaterals, or other shapes depending on the specific meshing settings and the geometry of the object and In ANSYS, the "Curvature Size Function" is a feature used in meshing elements the local curvature of the geometry (Refer Fig 3.6). The powerful tool that allows the user make refine mesh in regions where the geometry has complex or highly curved features, ensuring accurate replica of the object's shape and behaviour in those critical areas. These are particularly advantage's when analysing complex geometries, like in automotive components, aerospace structures, biomedical devices, where accurate representation of curvature is crucial for obtaining reliable simulation results. (Refer Fig. 3.7, Fig. 3.8, Fig. 3.9 & Fig. 3.10)

Sizing	
Use Advanced Si...	On: Proximity and Curvature
Relevance Center	Medium
Initial Size Seed	Active Assembly
Smoothing	High
Transition	Fast
Span Angle Center	Coarse
<input type="checkbox"/> Curvature Nor...	Default (70.3950 °)
<input type="checkbox"/> Num Cells Acr...	Default (3)
Proximity Size Fu...	
<input type="checkbox"/> Min Size	Default (0.837950 mm)
<input type="checkbox"/> Proximity Min ...	Default (0.837950 mm)
<input type="checkbox"/> Max Face Size	Default (83.7950 mm)
<input type="checkbox"/> Max Size	Default (167.590 mm)
<input type="checkbox"/> Growth Rate	Default (1.850)
<input type="checkbox"/> Minimum Edge L...	5.0 mm

Fig 3.6. Model with circular openings at midspan

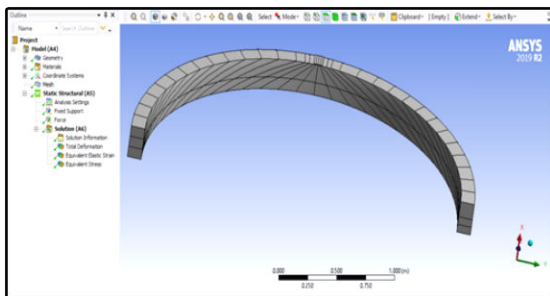

Fig 3.7. Model with no opening

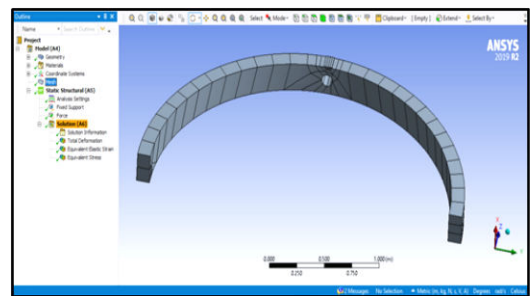

Fig 3.8. Model with circular opening at midspan

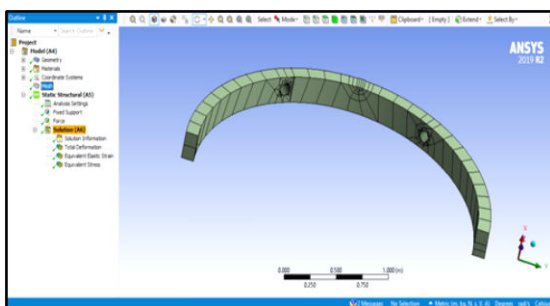

Fig 3.9. Model with openings at L/3

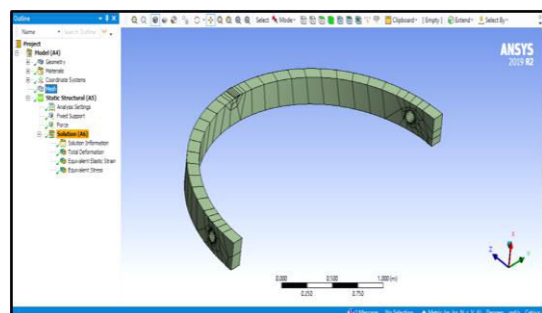

Fig 3.10. Model with Circular Openings nearer to Support

Loading:

The static structural model considers fixed support at both ends, and the next step is to select and define the required force in the static structural model. In this model, 26.12kN is applied to the loading pad at the centre of the span. Figures below shows loading positions (Refer Fig 3.11, Fig 3.12, Fig 3.13 and Fig 3.14).

Load calculation

$$\begin{aligned}
 \text{Self-weight of beam (D.L)} &= b \times D \times l \times 25 \\
 &= 0.120 \times 0.238 \times 4.571 \times 25 \\
 &= 3.264 \text{ kN}
 \end{aligned}$$

$$\begin{aligned} \text{Live load (L.L)} &= \text{live load} \times \text{span} \\ &= 5 \times 4.571 \\ &= 22.855 \text{ kN} \\ \text{Therefore, Total load} &= 3.264 + 22.855 \\ &= 26.12 \text{ kN} \end{aligned}$$

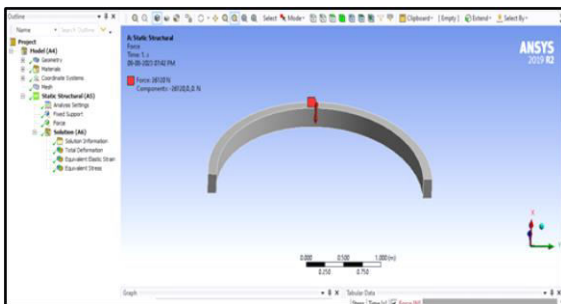

Fig 3.11. Model with no opening

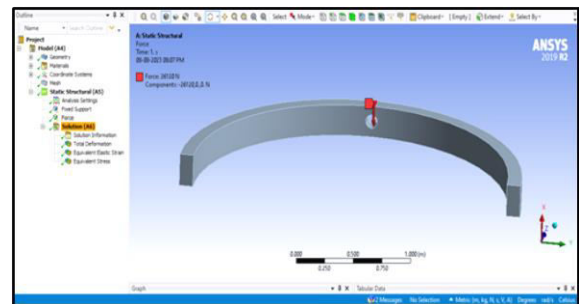

Fig 3.12. Model with circular opening at midspan

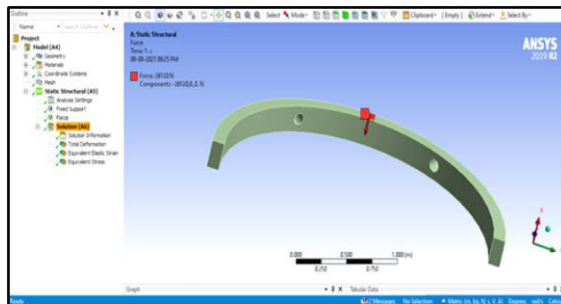

Fig 3.13. Model with openings at L/3

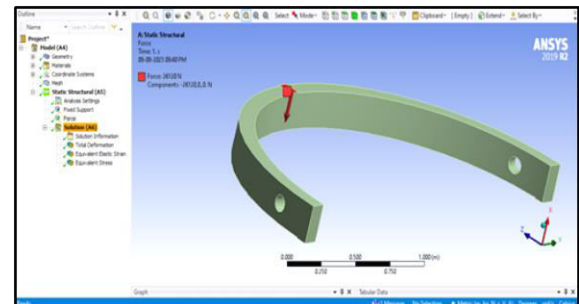

Fig 3.14. Model with Circular Opening nearer to Support

IV. EXPERIMENTAL RESULTS

The analysis of the finite elements of the models in this present study represents the results obtained from ANSYS R21. For this study a total of 4 beams were analysed. One beams with no opening, one beams with circular opening at mid span, one beams with Circular opening at L/3 and One beams with circular opening at shear zone or nearer to support of 50 mm diameter. Concentrated load of 26.12 kN was applied at the mid span and the results Models, Equivalent (von mises) Stress distribution, Relative deformation (Strain) and Total deformation (Overall deformation of the system) of all the beams have been discussed below,

Total Deformation:

- By referring to Table 2 and Fig.3.17 we know that the curved beam which incorporated with the circular openings at L/3 outperforms the models. It exhibits the least amount of deformation, indicating better structural stability and potentially a longer lifespan for the structure in conditions with the other locations.
- The curved beams with no opening (Fig.3.15), which is also having low deformation, but they do perform as well which is considered to be circular model. However, they still offer a reasonable level of structural stability.
- By again referring to Table 2 and Fig.3.16 The beam which incorporated with the midspan openings exhibits a significantly larger amount the values of the considered deformation compared to L/3 model. This higher deformation (Fig. 3.16) may raise concerns about the structural integrity and could indicate a higher risk of failure or reduced lifespan. Considering these findings, the opening at L/3 model is the best choice among the three locations to give openings, as it offers the least deformation and potentially the highest structural performance.

However, it is essential to consider other factors as well, such as stress distribution and strain levels, to make a comprehensive decision and ensure the best overall performance for the specific application.

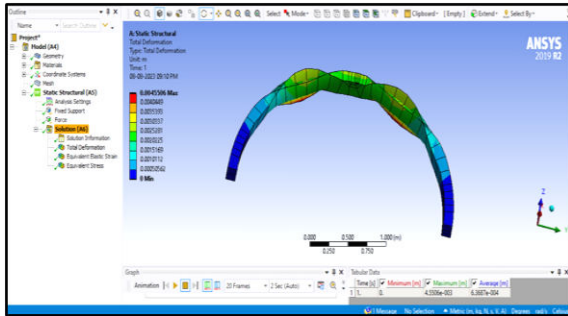

Fig 3.15. Model with no opening

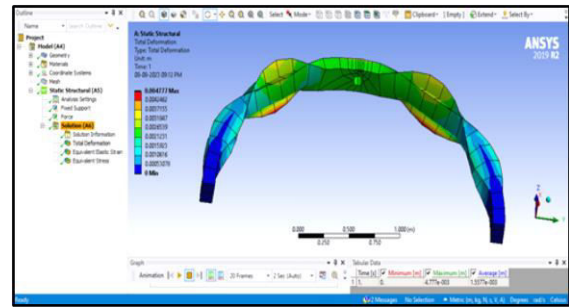

Fig 3.16. Model with circular opening at midspan

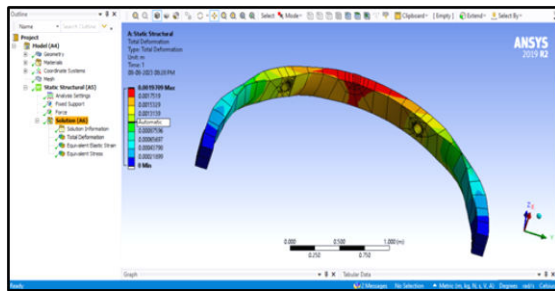

Fig 3.17. Model with openings at L/3

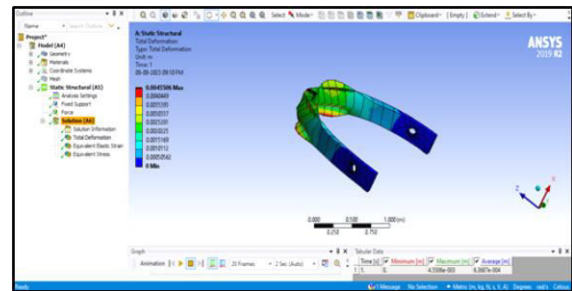

Fig 3.18. Model with Circular Opening nearer to Support

Types of models	Deformation in mm
Curved beam without opening	0.0018671
Curved beam opening at midspan	0.004777
Curved beam opening at l/3	0.0019709
Curved beam opening nearer to support	0.0045506

Table 2: Deformation in mm

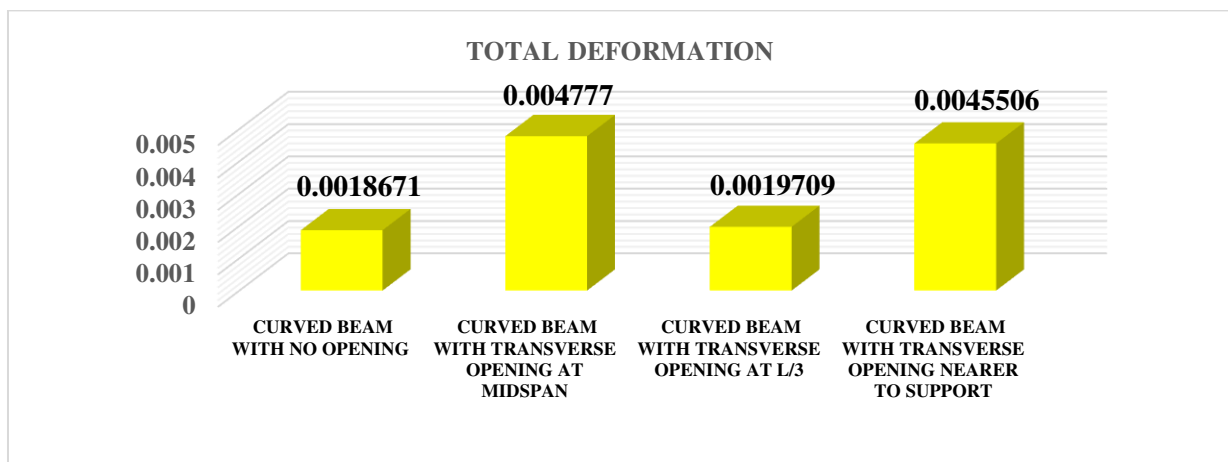

Fig 3.19. Graphical representation of Total deformation.

Strain:

- By referring to Table 3 and Fig.3.22 we know that the curved beam which incorporated with the circular openings at L/3 outperforms the models. It exhibits the least amount of deformation, indicating better structural stability and potentially a longer lifespan for the structure in conditions with the other locations.
- The curved beams with no opening (Fig.3.20), which is also having low deformation, but they do perform as well which is considered to be circular model. However, they still offer a reasonable level of structural stability.
- By again referring to Table 3 and Fig.3.21 The beam which incorporated with the midspan openings exhibits a significantly larger amount the values of the considered strain compared to L/3 model. This higher strain (Fig. 3.21) may raise concerns about the structural integrity and could indicate a higher risk of failure or reduced lifespan. Considering these findings, the opening at L/3 model is the best choice among the three locations to give openings, as it offers the least strain and potentially the highest structural performance. However, it is essential to consider other factors as well, such as total deformation and stress levels, to make a comprehensive decision and ensure the best overall performance for the specific application

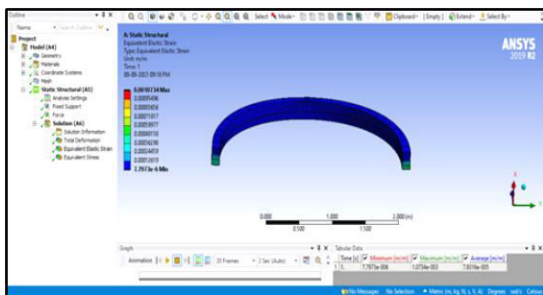

Fig 3.20. Model with no openings

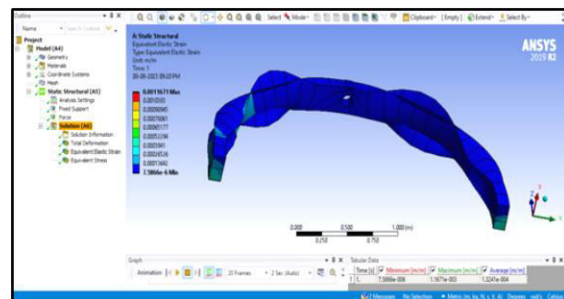

Fig 3.21. Model with circular openings at midspan

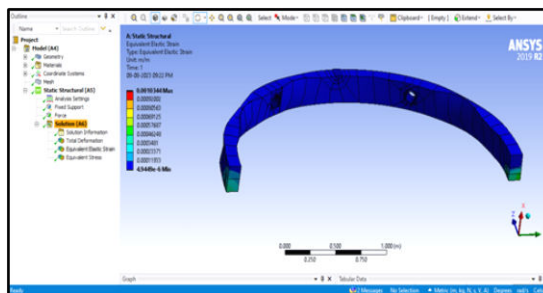

Fig 3.22. Model with openings at L/3

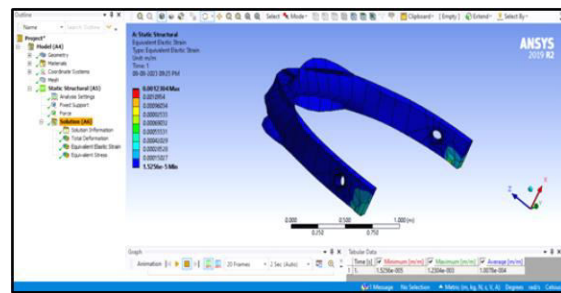

Fig 3.23. Model with Circular opening at shear zone

Types of models	Strain in Mpa
Curved beam without opening	0.0010734
Curved beam opening at midspan	0.0011671
Curved beam opening at l/3	0.0010344
Curved beam opening nearer to support	0.0012304

Table 3: Strain Results in Mpa.

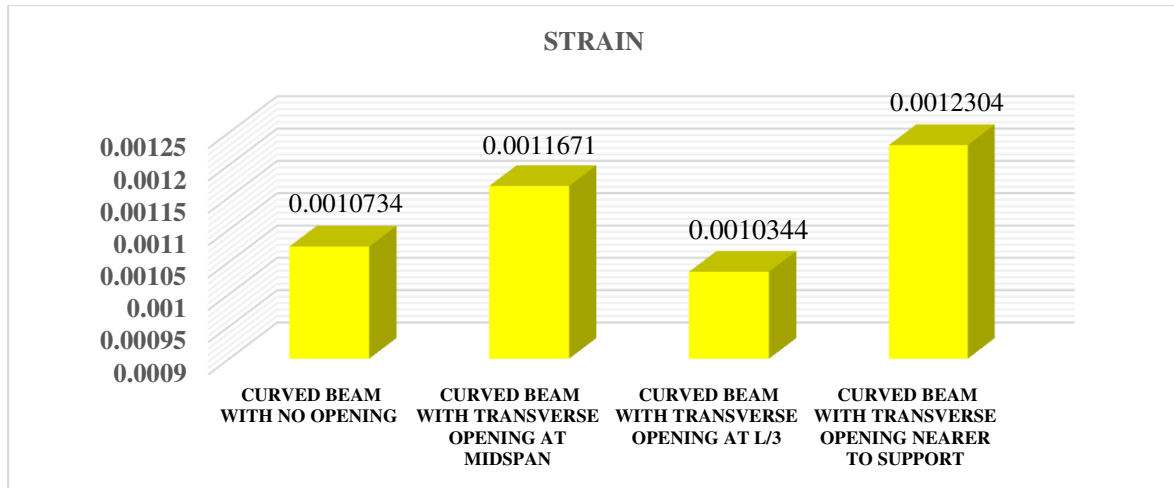

Fig 3.24. Graphical representation of Strain Results.

Stress:

- By referring to Table 4 and Fig.3.27 we know that the beam which incorporated with the circular openings at L/3 exhibits better performance against to other models. This model shows lower stress levels, particularly at the supports under a loading of 26.12 KN (Fig. 4.27), indicating improved structural and a reduced risk of material failure. Conversely,
- The curved beam which incorporated with opening near to the support experiences a significantly higher amount of stress (Fig.3.28). This substantial increase in stress raises concerns about the structural integrity and indicates a higher risk of potential deformation or failure under the same applied load. Considering these stress analysis findings,
- The beam which has openings at L/3 appears to be among three models its better performing models among the three positions (Fig.3.29). It exhibits lower stress levels, especially at critical locations like at the supports, making it a preferable choice for this specific loading scenario.

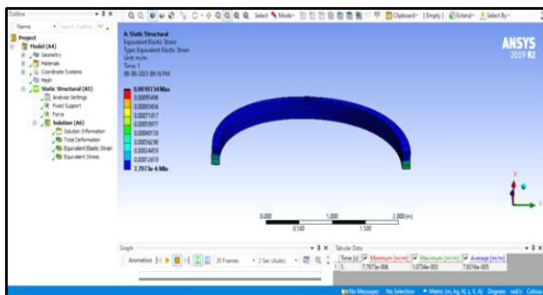

Fig 3.25. Model with no openings

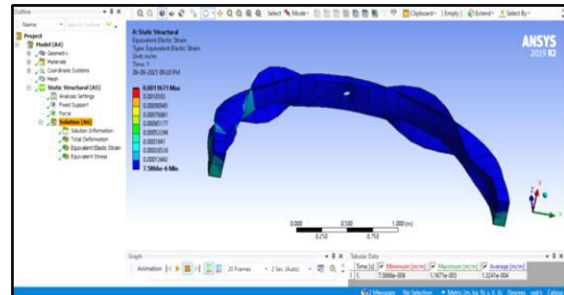

Fig 3.26. Model with circular openings at midspan

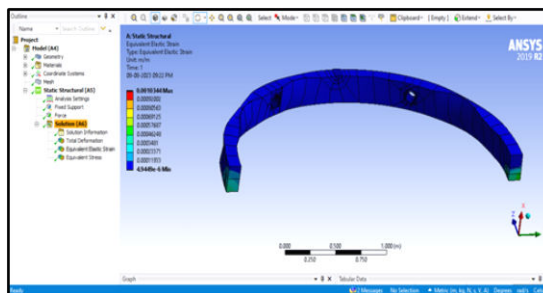

Fig 3.27. Model with openings at L/3

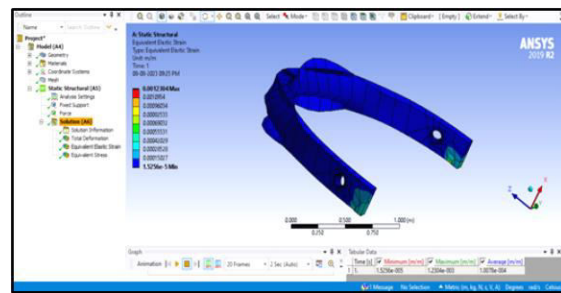

Fig 3.28. Model with Circular Opening at Shear zone



Types of models	Stress in Mpa
Curved beam without opening	2.44E+08
Curved beam opening at midspan	2.41E+08
Curved beam opening at l/3	2.09E+08
Curved beam opening nearer to support	2.79E+08

Table 4: Stress results in Mpa.

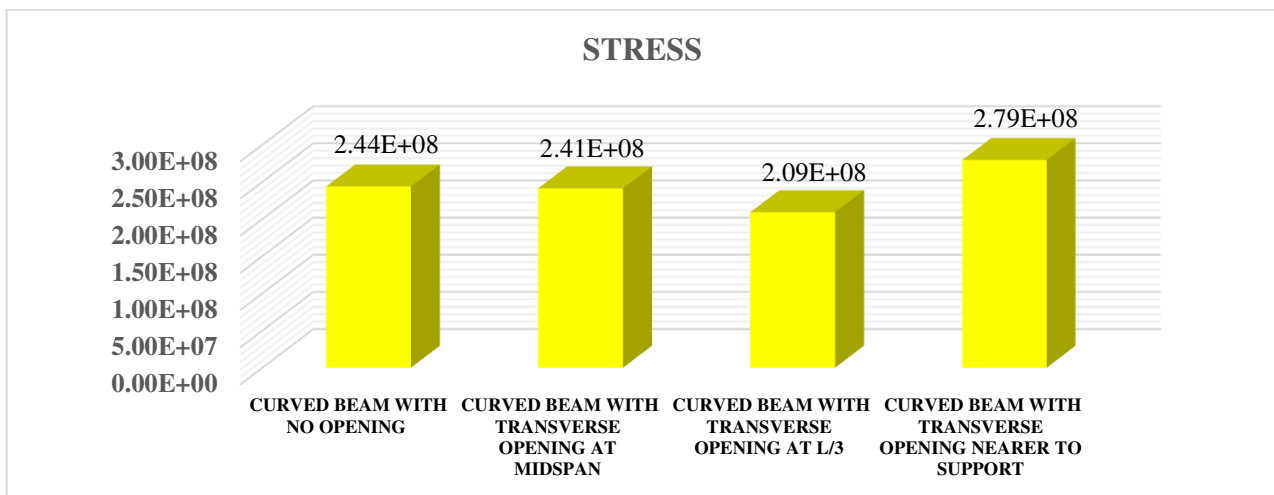

Fig 3.29. Graphical representation of Stress Results.

V. CONCLUSION

Upon the comprehensive analysis of stress, strain, and total deformation, beam with openings at L/3 proves to be the most promising and efficient model among the three different locations of the sections. Here is the final conclusion:

1. Stress Analysis: The beam with openings at L/3 exhibits the lowest stress levels, particularly at the supports under a loading of 26.12KN. This indicates better load distribution and structural stability compared to the other models (Refer Fig 3.29).
2. Strain Analysis: The opening at L/3 model shows the lowest strain levels refer Fig 3.24, especially at the supports under the same loading condition. This shows that it can handle the applied load more efficiently with reduced risk of material failure or deformation.
3. Total Deformation: The beam with openings at L/3 also demonstrates the least amount of total deformation refer Fig 3.19 This points to superior structural integrity and dimensional stability against other models.
4. Considering all these factors, the beam which have opening at L/3 appears to be the best choice among the three positions. It offers improved stress distribution, lower strain levels, and minimal total deformation, indicating better overall structural performance and potentially a longer lifespan for the structure.

REFERENCES

1. Amar farouk izzet & Hayder abdul wahid khalaf. (2020) "Performance of Reinforced concrete with beams multiple openings." ISSN: 1662-9795, Vol. 857 issue PP 162- 168, August-2020
2. Athira Boselal, Archana Sukumaran (2018), "Semicircular Curved Beam Opening Strengthened by Various Laminates", International Journal of Engineering Research & Technology, Vol.-06, pp: 1-04.
3. Swathy S Pillai, Alice Johny (2018), "Analytical Study on Shear Behaviour of Reinforced Concrete Beam with Varying Shapes of Web Opening", International Journal of Engineering Research & Technology, Vol. 06, and
4. Dr. Lucy Mohammed Shatner, Eng. Salam Anji Hussein, Laith Falah Hasan (2018), "Theoretical Evaluation of RC Deep Beam with Web Opening by Using Nonlinear Finite Element Software", International Journal of Scientific & Engineering Research, Vol. 09, pp: 413-421.



5. Subhajit Mondal, Bandyapadhyaya J.N, Chandra Pal Gautam (2011),
“Strengthening And Rehabilitation of Reinforced Concrete Beams with opening”,
International Journal of Civil and Structural Engineering, Vol. 02, pp: 127-137.
6. S.C. Chin, N. Shafiq and M.F. Nooruddin (2012), “Strengthening of RC Beams with Large Openings in Shear by CFRP Laminates: 2D Nonlinear FE Analysis”, International Journal of Civil and Environmental Engineering, Vol:6, pp: 153-158.
7. Saeed Ahmed Al-Sheikh (2014), “Flexural Behaviour of RC Beams with Opening”, Concrete Research Letters, Vol. 5. pp:128-964
8. Oh, K. & Shin, S. W. (2001).
ACI Structural Journal, 98(2), 164-173.
9. Shin, S. W. (2001). ACI Structural Journal, 98(2), 164-173
10. Sweeney, Gerry & Saadeh, Shuaib, (2020) Civil Engineering Research in Ireland issue:3/august/2020.
11. Ali Hameed Aziz, (2016) Volume 20, Issue: 01/2016 at JEASD.



INNO SPACE
SJIF Scientific Journal Impact Factor
Impact Factor: 8.423



ISSN INTERNATIONAL
STANDARD
SERIAL
NUMBER
INDIA



INTERNATIONAL JOURNAL OF INNOVATIVE RESEARCH

IN SCIENCE | ENGINEERING | TECHNOLOGY

9940 572 462 **6381 907 438** **ijirset@gmail.com**



www.ijirset.com

Scan to save the contact details