



e-ISSN: 2319-8753 | p-ISSN: 2347-6710

IJRSET

International Journal of Innovative Research in
SCIENCE | ENGINEERING | TECHNOLOGY



INTERNATIONAL JOURNAL OF INNOVATIVE RESEARCH

IN SCIENCE | ENGINEERING | TECHNOLOGY

Volume 13, Issue 4, April 2024

ISSN INTERNATIONAL
STANDARD
SERIAL
NUMBER
INDIA

Impact Factor: 8.423

 9940 572 462

 6381 907 438

 ijirset@gmail.com

 www.ijirset.com

Development of Direct Type of Solar Dryer

Yash Bhande, Yash Narela, Sarang Pund, Yash Chahaka, Sameer Padalkar, Harshal Patil

U.G. Student, Department of Mechanical Engineering, PRMIT&R, Badnera, Amravati, Maharashtra, India

U.G. Student, Department of Mechanical Engineering, PRMIT&R, Badnera, Amravati, Maharashtra, India

U.G. Student, Department of Mechanical Engineering, PRMIT&R, Badnera, Amravati, Maharashtra, India

Assistant Professor, Department of Department of Mechanical Engineering, PRMIT&R, Badnera, Amravati, Maharashtra, India

ABSTRACT: In many countries of the world, the use of solar thermal systems in the agricultural area to conserve vegetables, fruits, coffee and other crops has shown to be practical, economical and the responsible approach environmentally. Solar heating systems to dry food and other crops can improve the quality of the product, while reducing wasted produce and traditional fuels—thus improving the quality of life, however the availability of good information is lacking in many of the countries where solar food processing systems are most needed. Solar food dryers are available in a range of size and design and are used for drying various food products. It is found that various types of driers are available to suit the needs of farmers. Therefore, selection of dryers for a particular application is largely a decision based on what is available and the types of dryers currently used widely. A comprehensive review of the various designs, details of construction and operational principles of the wide variety of practically realized designs of solar-energy drying systems reported previously is presented. A systematic approach for the classification of solar-energy dryers has been evolved. Two generic groups of solar-energy dryers can be identified, viz. passive or natural-circulation solar-energy dryers and active or forced-convection solar-energy dryers. Some very recent developments in solar drying technology are highlighted.

KEYWORDS: Converting light to heat, Trapping heat, Food security and sustainability

I. INTRODUCTION

Drying using the sun under the open sky for preserving food and agricultural crops has been practiced since ancient times. However, this process has many disadvantages: spoilt products due to rain, wind, moisture and dust; loss of produce due to birds and animals; deterioration in the harvested crops due to decomposition, insect attacks and fungi, etc. Further, the process is labor intensive, time consuming and requires a large area for spreading the produce out to dry. Artificial mechanical drying, a relatively recent development, is energy intensive and expensive, and ultimately increases the product cost.[1]

Solar-drying technology offers an alternative which can process the vegetables and fruits in clean, hygienic and sanitary conditions to national and international standards with zero energy costs. It saves energy, time, occupies less area, improves product quality, makes the process more efficient and protects the environment. Solar drying can be used for the complete drying process or as a supplement to artificial drying systems, in the latter case reducing the fuel energy required. Solar dryer technology can be used in small-scale food processing industries to produce hygienic, good quality food products. At the same time, this can be used to promote renewable energy sources as an income-generating option. Further, this solar technology is ideally suited for women since they can place a load in the dryer and then get on with their other numerous tasks.[1]

Solar drying is a potential decentralized thermal application of solar energy particularly in developing countries [2], [3], [4], [5]. However, so far, there has been very little field penetration of solar drying technology. In the initial phase of dissemination, identification of suitable niche areas for using solar dryers would be extremely helpful towards their market penetration. In this context, one of the possible areas of immediate intervention in developing countries appears to be the solar drying of cash crops such as tobacco, tea, coffee, grapes raisin, small cardamom, chilli, coriander seeds, ginger, turmeric, black pepper, onion flakes, and garlic flakes, etc. For such crops, even with the capital-intensive nature of solar dryers, the unit cost of solar drying is expected to be a small fraction of the selling price of the dried product. In this paper, an attempt has been made towards potential assessment of solar drying of some cash crops in

India. The resulting net mitigation of CO₂ emissions due to realization of the estimated potential of solar drying of the selected cash crops has also been estimated.

Solar drying is often differentiated from “sun drying” by the use of equipment to collect the sun’s radiation in order to harness the radiative energy for drying applications. Sun drying is a common farming and agricultural process in many countries, particularly where the outdoor temperature reaches 30 °C or higher. In many parts of South East Asia, spice crops and herbs are routinely dried. However, weather conditions often preclude the use of sun drying because of spoilage due to rehydration during unexpected rainy days. Furthermore, any direct exposure to the sun during high temperature days might cause case hardening, where a hard shell develops on the outside of the agricultural products, trapping moisture inside. Therefore, the employment of solar dryer taps on the freely available sun energy while ensuring good product quality via judicious control of the radiative heat. Solar energy has been used throughout the world to dry food products. Such is the diversity of solar dryers that commonly solar-dried products include grains, fruits, meat, vegetables and fish.

II. CLASSIFICATION OF SOLAR DRYER

Drying equipment may be classified in several ways. The two most useful classifications are based on [7] the method of transferring heat to the wet solids or [7] the handling characteristics and physical properties of the wet material. The first method of classification reveals differences in dryer design and operation, while the second method is most useful in the selection of a group of dryers for preliminary consideration in a given drying problem. A classification chart of drying equipment on the basis of heat transfer is shown in Figure.

This chart classifies dryers as direct or indirect, with subclasses of continuous or batchwise operation. Solar-Visa vale - Principles, Classification and Selection of Solar Dryers Drying of Foods, Vegetables and Fruits 15 energy drying systems are classified primarily according to their heating modes and the manner in which the solar heat is utilized (Belsito’s et al., 2011). In broad terms, they can be classified into two major groups, namely:[8]

Drying equipment may be classified in several ways the two main useful classification are based on the

- The method of transferring heat to the solids.
- The handling characteristic and physical properties of the wet materials.

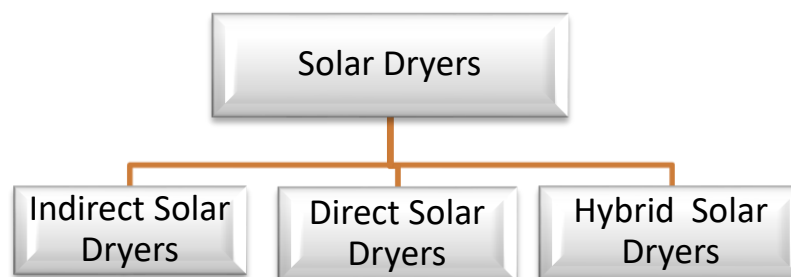

Figure 1. Classifications of dryers [06]

• Direct Type Dryers

Direct type dryers are like a cabinet with a compartment with a glass roof. Here solar rays directly fall onto the commodity through the glass and with the greenhouse effect, it’s been heated. The airflow carries away the moisture as shown below. Tunnel, Greenhouse, and cabinet-type dryers fall into this category.

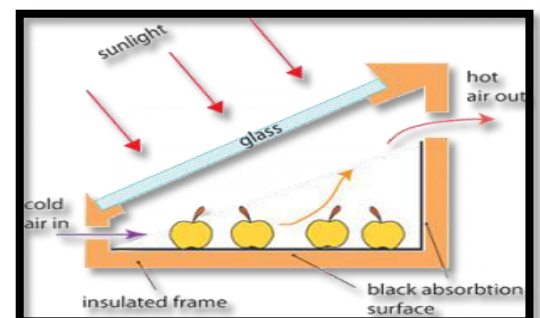

Figure 2:- Direct Type Dryers

• Indirect Type Dryers

Indirect type solar dryers have separate chambers for drying and heating airflow. In here there's no direct contact between solar rays and commodity as shown in the figure below. Airflow entering from solar collector gets heated up and carries away the moisture from drying chamber.[08]

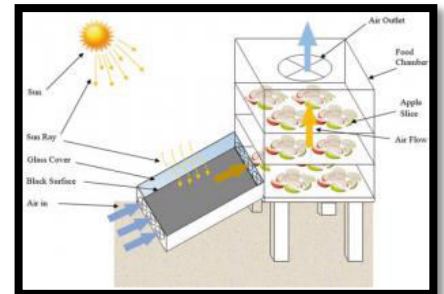

Figure 3:- Indirect type solar dryers

• Mixed-mode Dryers

Mixed-mode dryers are a combination of above two types. The structure is similar to indirect dryer but drying chamber is made of transparent material so that the solar collector and drying chamber both get heated up by the greenhouse effect.

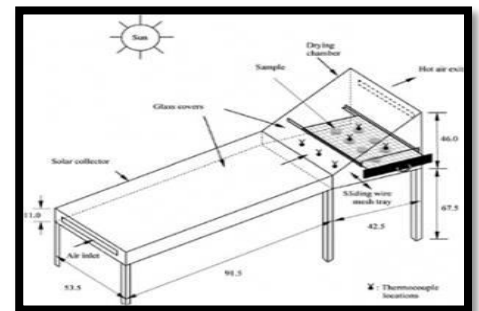

Figure 4:- Mixed-mode dryers

III. PRINCIPLE OF SOLAR DRYER

Drying is basically a phenomenon of removal of liquid by evaporation from a solid. Mechanical methods for separating a liquid from a solid are not generally considered drying. In the following section an attempt is made to provide a concise overview of the fundamental principles of drying process for agricultural products. These principles are applied, in general, to mechanical conventional drying and here concerned mainly with solar drying. However, in general, must be noted that conventional drying principles and phenomena are independent of the type of energy used. gives a comprehensive review of fundamental principles and theories igoverning the drying process. A major part of energy consumption during drying is for the evaporation of liquid water in to its vapour (2258 kJ/kg at 101.3 kPa). The water may be contained in the solid in various forms like free moisture or bound form which directly affects the drying rate. Moisture content is expressed Either on dry or wet basis, e.g. moisture content in wet basis is the weight of moisture per unit of wet material.

The basic principles employed in a solar dryer are:[13]

- Converting light to heat Any black on the inside of a solar dryer will improve the effectiveness of turning light into heat.
- Trapping heat isolating the air inside the dryer from the air outside the dryer makes an important difference. Using a clear solid, like a plastic bag or a glass cover, will allow light to enter, but once the light is absorbed and converted to heat, a plastic bag or glass cover will trap the heat inside. This makes it possible to reach similar temperatures on cold and windy days as on hot days.
- Moving the heat to the food. Both the natural convection dryer and the forced convection dryer use the convection of the heated air to move the heat to the food.

IV. DESIGN CONSIDERATION

The dryer was constructed using plywood, stainless steel mesh, wooden skewers, clear glass, galvanized iron sheet and axial fan for operation of the dryer which are locally available with low cost.

The thickness of banana slices was selected to be 4–5 mm.[09] An indirect type of solar dryer was considered as it does not affect the colour and nutrient content of the produce as in the case with a direct type. Also, the drying is uniform without any localized heating. Flat plate collector is used since it is easy to fabricate and also economical. The collector is made up of GI sheet of 0.6 mm thick as it is a good conductor and economical. It was painted black to increase the absorption of heat. The recommended glass thickness for collector is 5 mm. Air gap of 5 cm is recommended for a tropical climate.[10]

The insulating material was selected to be plywood as it is a good insulator as well as environmentally friendly. It also does not have any carcinogenic effects which other popular insulating materials like glass wool have. To reduce the heat loss, a layer of air sand witted between two plywood sheets. To further reduce the heat loss by radiation and to avoid moisture absorption by wood, aluminium foil is wrapped on the inside of the chamber.[10]

Food grade stainless steel mesh for the trays and food grade wooden skewers were selected for placing of banana. To ensure the constant flow rate of air during the experimentation, an axial flow fan was selected based on the calculations of pressure drop in the system and the required flow rate limit of air at 3 m/s. For the purpose of experimentation, 1.5 kg of banana.[10]

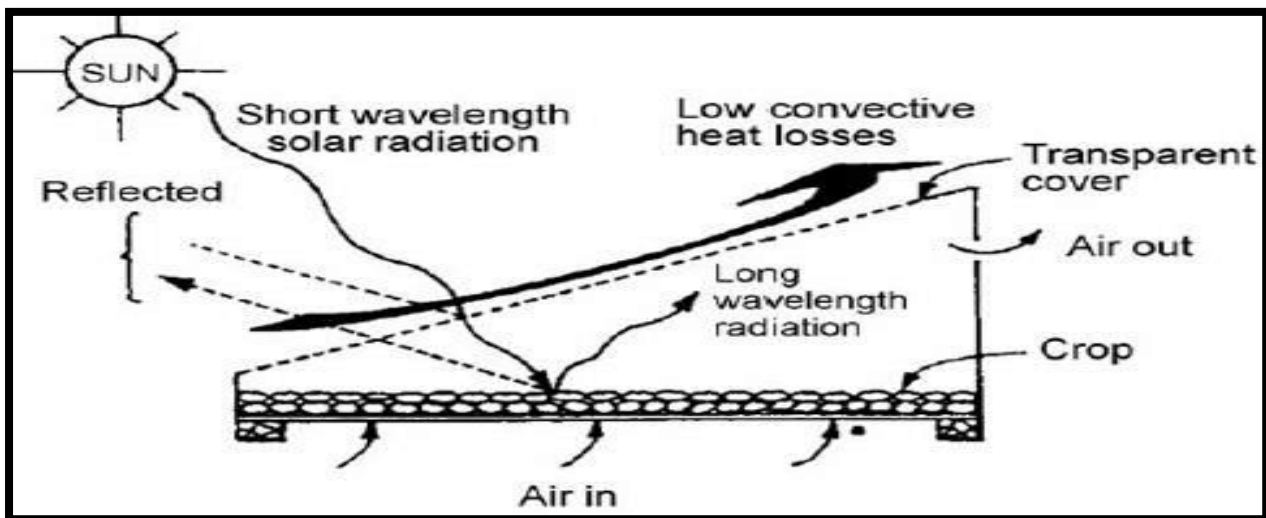

Figure 5: - Design Consideration of Solar

V. EXPERIMENTAL PROCEDURE

The experimental model of the solar dryer which basically consists of Solar Air Collector and Drying Chamber is tested by using a small amount of green peas. Firstly, the skin over the green peas is peeled and three sets of green peas, which are of 120 gm each are kept in three of the trays. The experiment is conducted from 10 A.M to 2 P.M on two separate days which had similar amounts of solar insolation. To get to a steady state condition the experimental measurement is started one hour prior to the actual readings taken. On the first air is distributed through bottom of the chamber alone and holes in the vertical pipes are closed to avoid any air reach the tray other than the bottom source. And on the next day all the holes in the UPVC pipes are kept open such that air can be sent to each tray separately.[11]

During the experiment, temperatures at the inlet and outlet of air heater, five points on the aluminium absorber plate, inlet and outlet of the chamber, tray 1, tray 2 and tray 3 temperatures were noted. Along with this relative humidity of the drying chamber and velocity of drying air was also measured. Temperature was measured using RTD thermocouple

connected to data logger (Agilent Make) and these thermocouples were attached to the trays in the drying chamber and each tray had three thermocouples attached to it and average of the temperatures were taken for the study, Velocity measured using anemometer and here the velocity is retained constant around 12 m/s and a pyranometer is used to measure the solar radiation.[11]

VI. ACTUAL WORKING MODEL

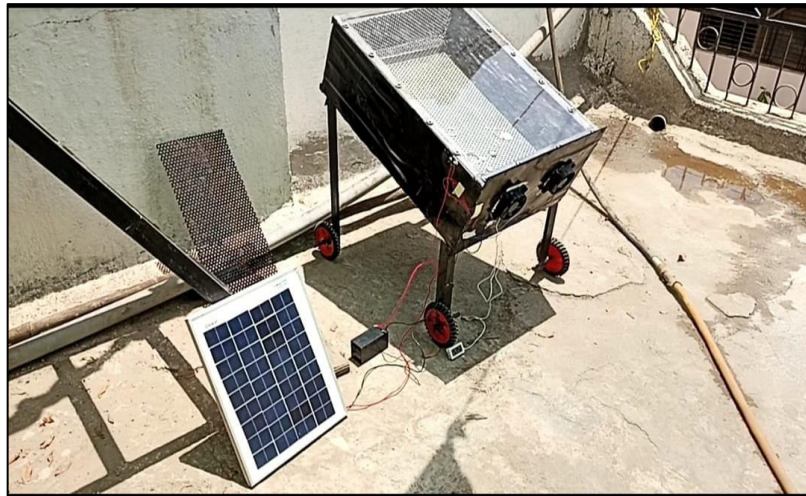

Figure 5:- Direct Type Solar Dryer



Figure 6:- Chamber for drying

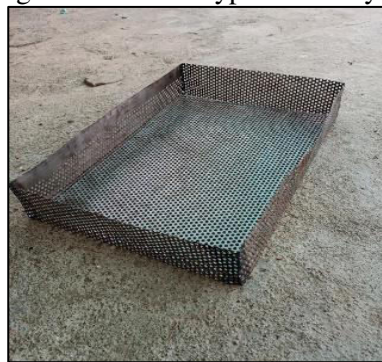

Figure 7:- Tray For Vegetable



Figure 8:- Thermometer

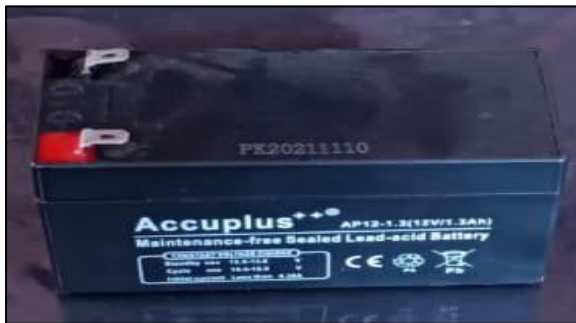

Figure 9 Battery {12V}



Figure 10 Exhaust Fan

VII. CONCLUSION

Solar drying has proved to be technically and economically valuable for several crops. It is, however, necessary to develop large-scale dryers that may be used throughout the year for different products to make them attractive to the farmers. Protection against UV radiation, dust, insects, mold, and other sources of contamination, as well as temperature and relative humidity control, are needed to improve the quality of the product. Likewise, the storage conditions of solar-dried products should be tailored to the crop and the packaging optimized if a long shelf-life is required. [12]

REFERENCES

1. O.V. Ekechukwu et al.
[Review of solar-energy drying systems II: an overview of solar drying technology](#)
Energy Convers Manage (1999)
2. J. Mumba [Development of a photovoltaic powered forced circulation grain dryer for use in the tropics](#)
Renew Energy (1995)
3. M.S. Sodha et al. [An analytical and experimental study of open sun drying and a cabinet type drier](#)
Energy Convers Manage (1985)
4. R.K. Goyal et al.
[Performance of a reverse flat plate absorber cabinet dryer: a new concept](#)
Energy Convers Manage (1999)
5. K.V. Chau et al.
[Performance of a plastic suspended screen solar air heater](#)
J Agric Eng Res (1980)
6. (Ekechukwu, 1999; Sharma et al., 2009)
7. Ayensu, A., Asiedu-Bondzie, V., 1986, Solar drying with convective self-flow and energy storage, Solar and Wind Technology, 3(4), pp. 273-279.
8. Baird, C.D., Deng, J.C., Chau, K.V., Heinis, J. J., Perez, M., 1981, Solar drying of seafood products, ASAE, 3, pp. 640-644
9. Amer BMA, Hossain MA, Gottschalk K (2010) Design and performance evaluation of a new hybride solar dryer. Energy Convers Manag 51:813-820
10. Suhas P Sukhatme, (2000) solar energy, principle of thermal conduction and storage New Delhi, India
11. Sadodin S and Kashani TT 2011 Computing Research Repository. 1102–22
12. M. Mathlouthi, in [Encyclopedia of Food Sciences and Nutrition \(Second Edition\)](#), 2003
13. Ekechukwu and Norton (1999) and Mujumdar, 2007



INTERNATIONAL
STANDARD
SERIAL
NUMBER
INDIA



INTERNATIONAL JOURNAL OF INNOVATIVE RESEARCH

IN SCIENCE | ENGINEERING | TECHNOLOGY

 9940 572 462  6381 907 438  ijirset@gmail.com



www.ijirset.com

Scan to save the contact details