



e-ISSN: 2319-8753 | p-ISSN: 2347-6710

IJRSET

International Journal of Innovative Research in
SCIENCE | ENGINEERING | TECHNOLOGY



INTERNATIONAL JOURNAL OF INNOVATIVE RESEARCH

IN SCIENCE | ENGINEERING | TECHNOLOGY

Volume 13, Issue 4, April 2024

ISSN INTERNATIONAL
STANDARD
SERIAL
NUMBER
INDIA

Impact Factor: 8.423

 9940 572 462

 6381 907 438

 ijirset@gmail.com

 www.ijirset.com

Automatic Student Attendance Using RFID

V. Selvendhiran¹, S. Sachin Surya², R. Srivarshan³, M. Harish⁴,

Professor. Dr. R. Senthilkumar, M.E, PhD⁵

Department of Robotics and Automation, Muthayammal Engineering College, Rasipuram, Namakkal,
Tamilnadu, India.

ABSTRACT: This paper is based totally on the find out about and the implementation of the pilot undertaking for customized, automated, especially secured classification room management system regarded as completely automatic school room attendance system. In this research paper, the strategies, design, improvement and implementation of a pilot project for classification room attendance administration structures is defined in detail. As a pilot project, cell app is constructed on Android platform the use of Xamarin programming. Prototype of proposed device presents excessive stage of authentication by using embedding face attention and biometric verification collectively with radio frequency identification gadget (RFID) system. Though given mannequin facets are specially designed for our university needs, however this mannequin can be modified for usual usage and can be utilized for all tutorial tiers i.e. school, college, universities. Among the different aspects of system, one necessary characteristic is decision of system to work in clever mode in which machine closes after predefined time.

KEY WORDS: Attendance System, Radio Frequency Identification Technology, Arduino, Liquid Crystal Display.

I. INTRODUCTION

In today's rapidly advancing technological world, the adoption of Information Technologies (IT) is changing the way we do business. Mobile devices, such as smart phones, have become ubiquitous and are constantly. Evolving to make our lives easier and more convenient. One of the latest developments in smart devices is Radio frequency identifier (RFID), which allows data transmission over short distances. RFID has a wide range of applications, including ticketing, access control, and mobile payments. It can also be used to bootstrap different types of connections, such as Bluetooth or Wi fi. Traditionally, student identification has relied solely on plastic cards, which can be easily copied and are prone to loss or theft. This method has faced various hurdles, such as complex and time-consuming processes for attendance and grade reporting, difficulty in accessing resources and booking library cards, and security concerns. However, with the emergence of secure and standards-based contactless smart card technology, this is changing. This project proposes an IoT-based identification card system using RFID technology to replace traditional plastic student cards. With RFID-enabled smart phones, students can use their devices or RFID cards for validation in lectures, access to resources, and entry to specific premises. This system also allows for easy access to subject and college information, attendance records, and degree reports, which can be accessed from the convenience of their mobile devices. The system comprises an Android application in future that reads the RFID tag card, saves the unique ID of the student, and allows access to the student's information web application is also developed to store student information on the server, ensuring easy access to student data and allowing for efficient administration. In conclusion, the IoT-based identification card system using RFID technology offers an innovative and secure solution to traditional plastic cards, providing convenient access to student information and resources. From a secure database stored on a server managed by the administration of students. The RFID tag card can also be changed to emulate a student card with RFID chip, allowing for easy access to university facilities.

II. RFID TECHNOLOGY

Radio Frequency Identification (RFID) technology is widely used in various applications, such as supply chain management, inventory control, and access control. RFID-based systems provide advantages over traditional methods by offering automatic identification, nonline-of-sight communication, and real-time tracking of tagged objects. As a result, RFID technology has become increasingly popular in the last decade, with various research studies being conducted to improve its performance and addresses its limitations. RFID technology has been extensively researched and applied in several fields, including healthcare, transportation, and manufacturing. For example, in health care, RFID-based systems have been proposed for patient tracking, asset management, and medication administration. In transportation, RFID technology has been used for to collection, vehicle identification, and parking management. In

manufacturing, RFID-based systems have been applied for production control, supply chain management, and quality control. Furthermore, various research studies have focused on enhancing the performance of RFID systems, such as increasing their read range, improving their accuracy, and reducing their cost. Some of the proposed solutions include using multiple antennas, designing efficient algorithms for tag identification, and developing low-cost tags using printable electronics. Overall, RFID technology has shown great potential in various applications, and IEEE papers have played a significant role in advancing its development and improving its performance.

III. LITERATURE REVIEW

1. T.S.Lim , S.C.Sim, M.M. Mansor “RFID based attendance system ”,University of multimedia Malacca, Malaysia,2009. In this paper, the system is takes automatic attendance of students by using RFID.
2. Karwan Jacksi, Falah Ibrahim, Shahab Ali, “Student Attendance Management System”, University of Zakho, Iraq, 2018. In this paper, the system is designed in a way that can differentiate the hours of theoretical and practical lessons since the rate of them is different for calculating the percentages of the student’s absence.
3. Ekta Chhatar, Heeral Chauhan, Shubham Gokhale, Sompurna Mukherjee, Prof. Nikhil Jha, “Survey on Student Attendance Management System”, S.B. Jain Institute of Technology, Management and Research, Nagpur, 2016. In this paper, the system deals with the maintenance of the student attendance. It generates the attendance of the student on the basis of presence and absence in class. The staffs will be provided with the separate username & password.
4. “Web Based Student Information Management”, S. R. Bharamagoudar et al., this paper assist in automating the existing manual system. It can be monitored and controlled remotely. This paper provides accurate information always. All years together gathered information can be saved and can be accessed at any time. The purpose is to design a Automatic Attendance which contains up to date information of the student. That should improve efficiency of college record management.
5. “Online Student Attendance System”, P. N. Garad et al, in this project, we gave access to three users i.e., Admin, Student. In this project teachers or the admin will be filling attendance. They will have privilege to fill attendance form, update attendance form, send message to the guardian’s account whose child is absent, also those attendance is less than 75%, and they also have privilege to send message to the students whose fees are pending. He staff can also view the message whenever they want and also can modify the details of students.
6. Zahraa Salah Dhaief, Department of Computer Science, College of Education, AL-Mustansiriyah University, Baghdad-Iraq “People counting technology”

IV. METHODOLOGY

The RFID reader is placed at the classroom. Whenever students enter the classroom RFID reader read the RFID tag and it store the all information (Entry time, Name, etc.) of students into database and maintain the system. Here admin of this system can view all data using the software interface by retrieving information from database without any difficulties not like traditional system. The aim of this project is to design an RFID Technology based Attendance System using Arduino, in which the attendance of students is automatically recorded with the help of a card. When this circuit is powered ON, initially the Arduino will display the message on the LCD display hold the tag/card near to the reader. When the RFID reader detects the ID card, it will store the data in the Arduino. By using suitable programming, it will convert to an excel sheet on the computer. During this process, LCD display shows the total number of students entered in the classroom and it also shows the total RFID card/tag scanned by the reader. If there is any difference in the count of RFID tags and total number of students present in the classroom, it gives alert to the system. So that difference shows the proxy in the attendance, then teacher has to manually correct the error of the attendance.

Block diagram

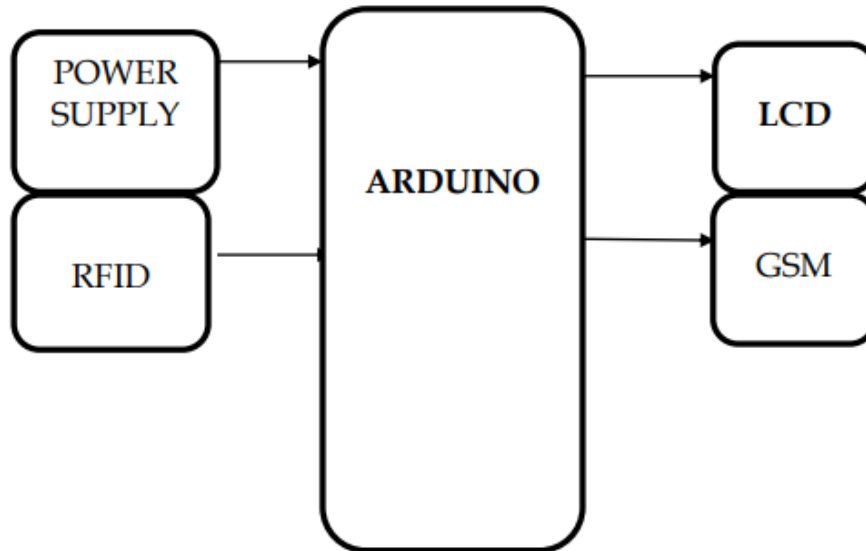

A. Arduino Uno the Arduino UNO is a standard board developed by Arduino.cc, based on an ATmega328P microcontroller. Its name, UNO, meaning 'one' in Italian, was chosen to mark the first release of Arduino Software and also because it was the first USB board released by the company. With its digital and analog Input/Output pins, shields, and other circuits, the Arduino UNO is a powerful board that is widely used in various projects. Compared to other boards such as the Arduino Mega, the UNO is easy to use and includes 6 analog pin inputs, 14 digital pins, a USB connector, a power jack, and an ICSP header. It is programmed through IDE, which stands for Integrated Development Environment, and can run on both online and offline platforms. The IDE is common to all available boards of Arduino, making it a versatile and reliable tool for developers and hobbyists alike.



Fig 1: Arduino uno board

B. GSM SIM900 A The use of GSM technology in monitoring and controlling transformer load is a highly efficient and cost-effective means of communication. With its deterministic character, GSM enables the remote control of DC motors, stepper motors, temperature sensors, and solid-state relays through a simple message sent via a GSM modem. This eliminates the need for manual operation and transportation, making it an ideal solution for industrial controls, automobiles, and appliances. The SIM900A modem, equipped with a SIM900A GSM chip and RS232 interface, allows for easy connection to a computer or microcontroller using USB to Serial or RS232 to TTL converters. By opening a serial connection and sending AT commands, the modem can be easily configured to perform various functions. With its reliability and ease of use, GSM technology is the preferred choice for remote control and monitoring applications.



Fig 2: GSM board

C. LCD (Liquid Crystal Display) A liquid crystal display, commonly known as LCD, derives its definition from the unique combination of two states of matter - solid and liquid. By utilizing liquid crystal technology, LCD screens produce a visually stunning image that is widely used in laptops, televisions, cell phones, and portable video games. Unlike the bulky cathode ray tube (CRT) technology, LCD's ultra-thin composition is made possible by its multiple layers, including polarized panel filters and electrodes. LCD technology is a popular choice for displaying images in electronic devices like mini computers and notebooks. As light passes through a lens, it interacts with the liquid crystal layer, creating a grayscale image that is then combined with colored light to produce a vivid, highquality image on the screen. In summary, LCD technology offers a sleek and efficient alternative to traditional display screens.

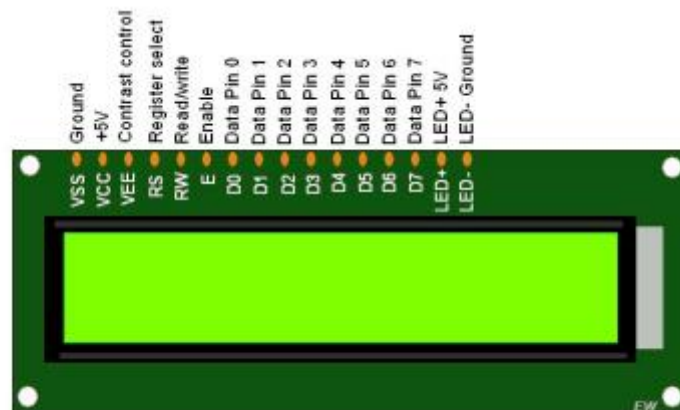

Fig 3: LCD Display

D. RFID Tag Radio frequency identification tag is an integrated circuit that uses radio frequency waves to identify objects. An RFID tag consists of an antenna and a microchip which are used to transmit and receive information. The microchip in the RFID tag stores whatever information the user wants in digital form.



Fig 4: RFID tag

E. RFID Reader

This device consists of antenna, transceiver and a detector. RFID reader send the radio waves and respond back after the tag detects this wave. Antenna used in this reader is used to convert electrical signal into electromagnetic signal. The transceiver part can be used either as a transmitter or receiver. When the antenna detects the RF signal from the tag, the data is retrieved with the help of decoder.

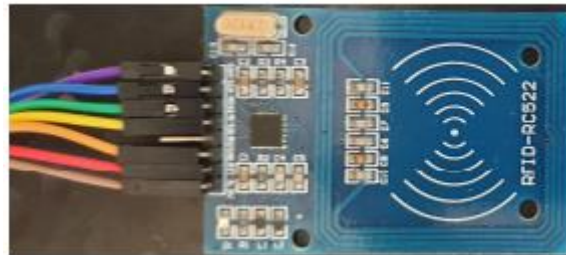





Fig 5: RFID reader

V. SIMULATION RESULTS

As the supply is given to system Project Name Smart Attendance System will be displayed on the LCD Screen.



Table:    

	roll_no	name	class	division	Attendance
	Filter	Filter	Filter	Filter	Filter
1	17	PRATHAMESH	BE	A	0
2	20	JAY	BE	A	1
3	29	MAYUR	BE	A	1
4	09	barne	BE	A	0
5	99	Shubham	BE	A	0

VI. CONCLUSION

In conclusion, the use of RFID cards in educational institutions has numerous advantages, such as simplifying attendance tracking, library book borrowing, and access control. By incorporating an Arduino-based terminal, we can easily scan and retrieve information encoded in the RFID card, which can be used to display relevant information about students in an Excel sheet. This system not only saves time but also reduces errors associated with manual data entry. Therefore, the integration of RFID technology with Arduino-based terminals has the potential to enhance the efficiency and accuracy of various operations in educational institutions.

VII. FUTURE SCOPE

The proposed RFID-based solution appears to be interesting and useful, with potential for further enhancements such as using student cards for NFC based payment within and outside the campus, integrating attendance management, and installing smart posters for various services. However, the system can be further optimized by replacing the internal wireless network with RFID technology to enable better tracking and monitoring of the students' movements within the campus. This can result in a more efficient and effective educational system.

REFERENCES

1. "RFID Technology in Health care: A Review" by Li Yang et al., 2021. This paper reviews the application of RFID technology in health care and its benefits in patient safety, medication management, and asset tracking.
2. "Design and Implementation of an RFID-Based Attendance Management System for Higher Education" by M. Salman et al., 2020. This paper presents the design and implementation of an RFID-based attendance management system for higher education institutions.
3. "A Comparative Study of RFID-Based Indoor Localization Techniques" by H. G hasemzadeh et al., 2019. This paper presents a comparative study of various RFID-based indoor localization techniques and their performance
4. "A Comparative Study of RFID-Based Indoor Localization Techniques" by H. Ghasemzadeh et al., 2019. This paper presents a comparative study of various RFID-based indoor localization techniques and their performance
5. "RFID-Based Monitoring System for Smart Home Environment" by M. H. Khan et al., 2021. This paper proposes an RFID-based monitoring system for smart homes that can detect the presence and location of objects and individuals.
6. "RFID-Based Patient Monitoring System for Smart Hospitals" by R. C. Sharma et al., 2020. This paper presents an RFID-based patient monitoring system for smart hospitals that can track patient movement, vital signs, and medication administration
7. "A Framework for RFID-Based Logistics Management in E-Commerce" by K. L. Lim et al., 2020. This paper proposes a framework for RFID-based logistics management in e-commerce that can improve supply chain efficiency and customer satisfaction
- 7 An RFID reference attendance system is a type of electronic attendance tracking system that uses radio frequency identification (RFID) technology to record attendance data. The system uses RFID tags that are assigned to each student or employee, and RFID readers that are placed in classrooms or other designated areas.
- 8 When a student to employee enters a designated area, the RFID reader detects their tag and records the it attendance automatically. The system can provide real-time attendance data and generate attendance reports for administrators. It can also be integrated with other systems such as school or company databases for more comprehensive tracking and analysis.
- 9 Besides attendance tracking, RFID reference systems can be used for other applications like access-control, asset-tracking, inventory-management, and more. In summary, RFID reference attendance systems provide an efficient and reliable solution for organizations that are looking to Stream line attendance tracking for increased productivity and academic success.
- 10 An RFID reference attendance system ensures accurate attendance tracking and eliminates the possibility of manual errors that existing traditional attendance systems. This technology assists with automating many administrative processes, making it easier for administrators to manage attendance in real-time and generates attendance reports quickly.
- 11 When a student or employee with an RFID tag enters the range of an RFID reader, the reader detects the unique ID tag, and automatically records attendance in the system. The system can also be configured to send notifications in real-time to designated stakeholders like parents or supervisors.
- 12 An RFID reference attendance system is a type of electronic attendance tracking system that utilizes RFID technology for data capture and monitoring. The system works by having RFID tags assigned to students or employees, which are then detected by RFID readers that are strategically placed in different are also facility, classroom, or location



INTERNATIONAL
STANDARD
SERIAL
NUMBER
INDIA



INTERNATIONAL JOURNAL OF INNOVATIVE RESEARCH

IN SCIENCE | ENGINEERING | TECHNOLOGY

 9940 572 462  6381 907 438  ijirset@gmail.com



www.ijirset.com

Scan to save the contact details